

TK

Transmissiekast

Transmissiekast	Adres	
	Transmissiekast	Ligging -
		Geo gegevens -
Onderhoud en beheer		
Elektrotechnische installateur		
Projectnummer	

Status
V1.0

Datum	7-11-2014	Wijziging	Datum	Naam
Bew.				
Gecontr				

Inhoudsopgave

Pagina	Paginatype	Paginabeschrijving	Datum	Revisie
=TK/1	Titelblad / voorblad	VOORBLAD	7-11-2014	V1.0
=TK/2	Inhoudsopgave	TEKENINGENLIJST	7-11-2014	V1.0
=TK/3	Inhoudsopgave	TEKENINGENLIJST	7-11-2014	V1.0
=TK/030	Schema enkellijnig	BLOKSCHEMA PLC NETWERK	7-11-2014	V1.0
=TK/140	Schema meerlijng	HOOFDSTROOM TRANSMISSIEKAST	7-11-2014	V1.0
=TK/141	Schema meerlijng	HOOFDSTROOM UTILITEITEN TRANSMISSIEKAST	7-11-2014	V1.0
=TK/142	Schema meerlijng	HOOFDSTROOM 12VDC	7-11-2014	V1.0
=TK/143	Schema meerlijng	HOOFDSTROOM 24VDC	7-11-2014	V1.0
=TK/145	Schema meerlijng	STUURSTROOM ETHERNET SWITCH	7-11-2014	V1.0
=TK/146	Schema meerlijng	STUURSTROOM LUIDSPREKERS	7-11-2014	V1.0
=TK/147	Schema meerlijng	STUURSTROOM CAMERA'S	7-11-2014	V1.0
=TK/150	Schema meerlijng	GLASVEZEL PATCHPANEEL	7-11-2014	V1.0
=TK/300	Schema meerlijng	PLC RACKINDELING KOPPEL-PLC	7-11-2014	V1.0
=TK/301	Schema meerlijng	PLC RACKINDELING ET200M	7-11-2014	V1.0
=TK/310	Overzicht	PLC OVERZICHT ET200M FS-DI KAART 1	7-11-2014	V1.0
=TK/311	Schema meerlijng	ET200M FS-DI KAART 1	7-11-2014	V1.0
=TK/312	Schema meerlijng	ET200M FS-DI KAART 1	7-11-2014	V1.0
=TK/313	Schema meerlijng	ET200M FS-DI KAART 1	7-11-2014	V1.0
=TK/314	Schema meerlijng	ET200M FS-DI KAART 1	7-11-2014	V1.0
=TK/315	Overzicht	PLC OVERZICHT ET200M FS-DO KAART 1	7-11-2014	V1.0
=TK/316	Schema meerlijng	ET200M FS-DO KAART 1 NOODSTOP BRUG	7-11-2014	V1.0
=TK/317	Schema meerlijng	ET200M FS-DO KAART 1 NOODSTOP (OPTIE 2e NAUTISCH OBJECT)	7-11-2014	V1.0
=TK/500	Schema meerlijng	KOPPELING EXTERNE INSTALLATIES	7-11-2014	V1.0
=TK/501	Schema meerlijng	KOPPELING EXTERNE INSTALLATIES (OPTIE 2e NAUTISCH OBJECT)	7-11-2014	V1.0
=TK/550	Schakelkastopbouw	Aanzicht apparatenkast AK1	7-11-2014	V1.0
=TK/600	Klemmenaansluitlijst	Klemmenaansluitlijst =TK-X2	7-11-2014	V1.0
=TK/601	Klemmenaansluitlijst	Klemmenaansluitlijst =TK-X4	7-11-2014	V1.0
=TK/602	Klemmenaansluitlijst	Klemmenaansluitlijst =TK-X5	7-11-2014	V1.0
=TK/603	Klemmenaansluitlijst	Klemmenaansluitlijst =TK-X7	7-11-2014	V1.0
=TK/604	Klemmenaansluitlijst	Klemmenaansluitlijst =TK-X9	7-11-2014	V1.0

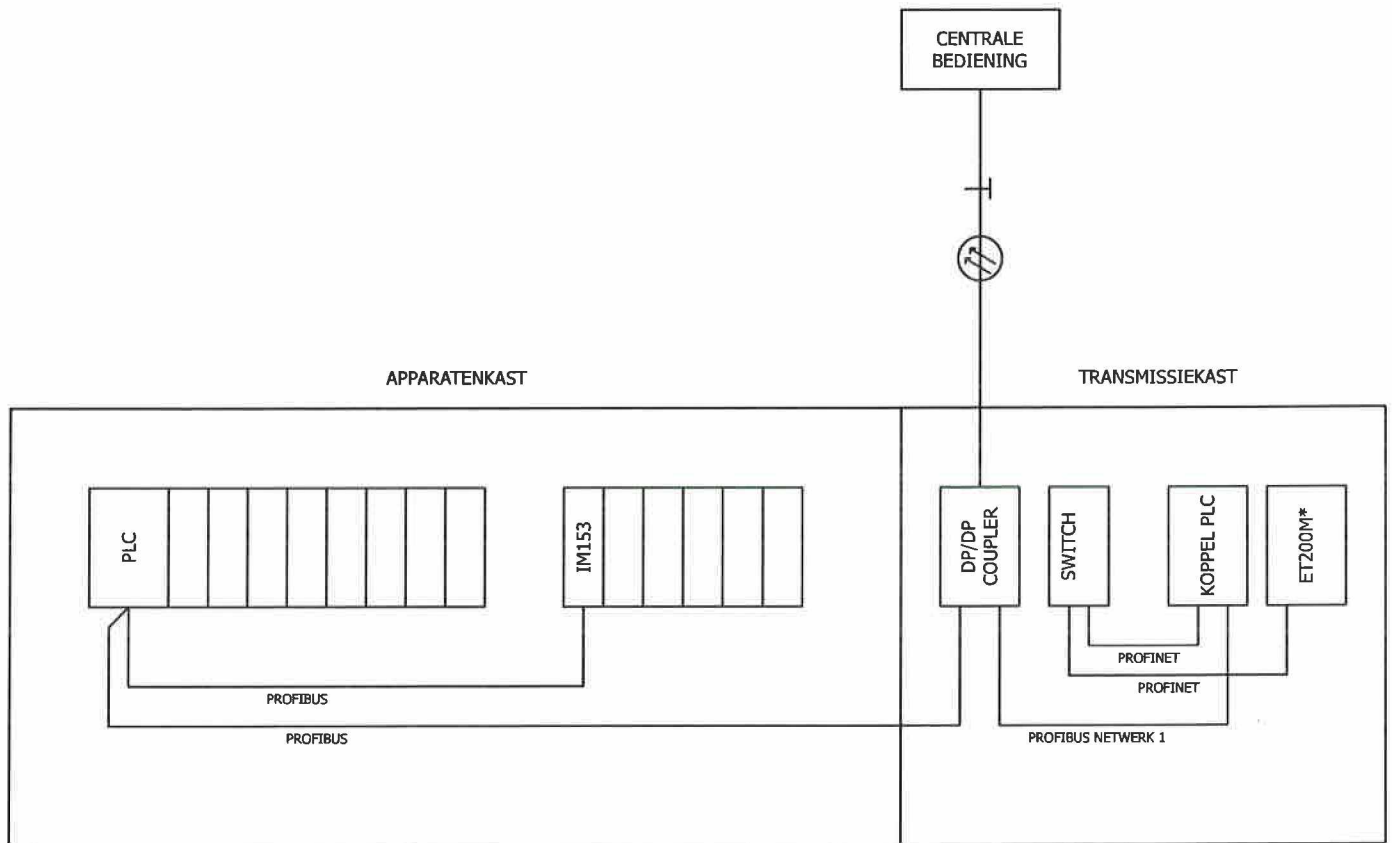

* ET200M t.b.v. koppeling noodstop van centrale bediening

Datum	7-11-2014	Wijziging	Datum	Naam
Bew.				
Gecont				

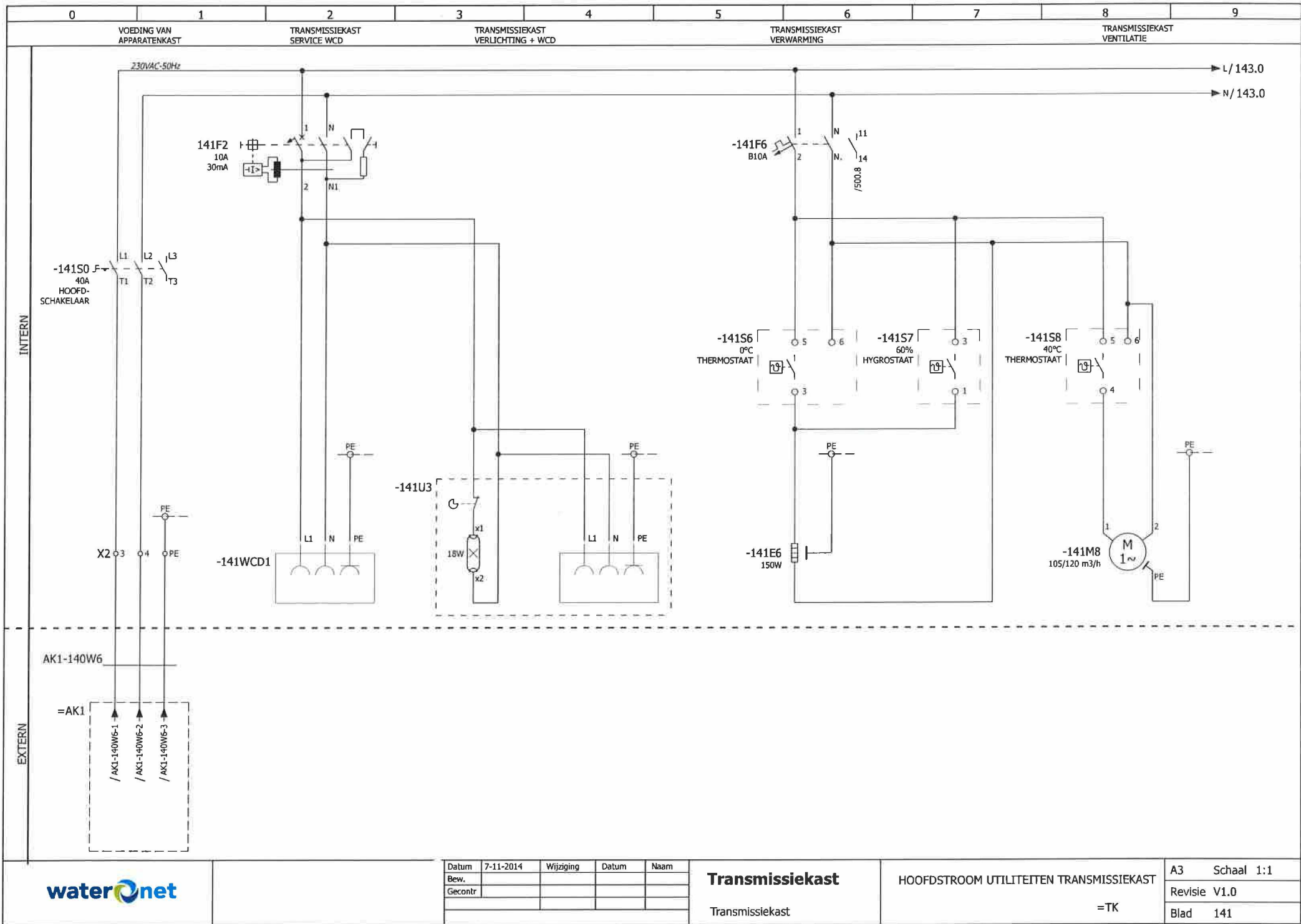

Datum	7-11-2014	Wijziging	Datum	Naam
Bew.				
Gecontr.				

12V VOEDING
KPN APPARATUUR

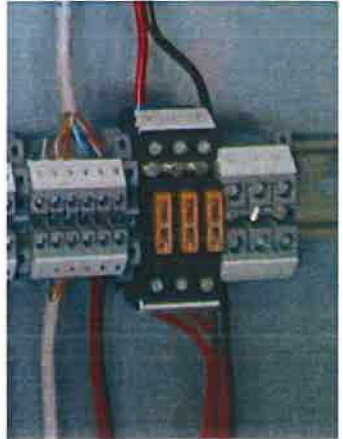
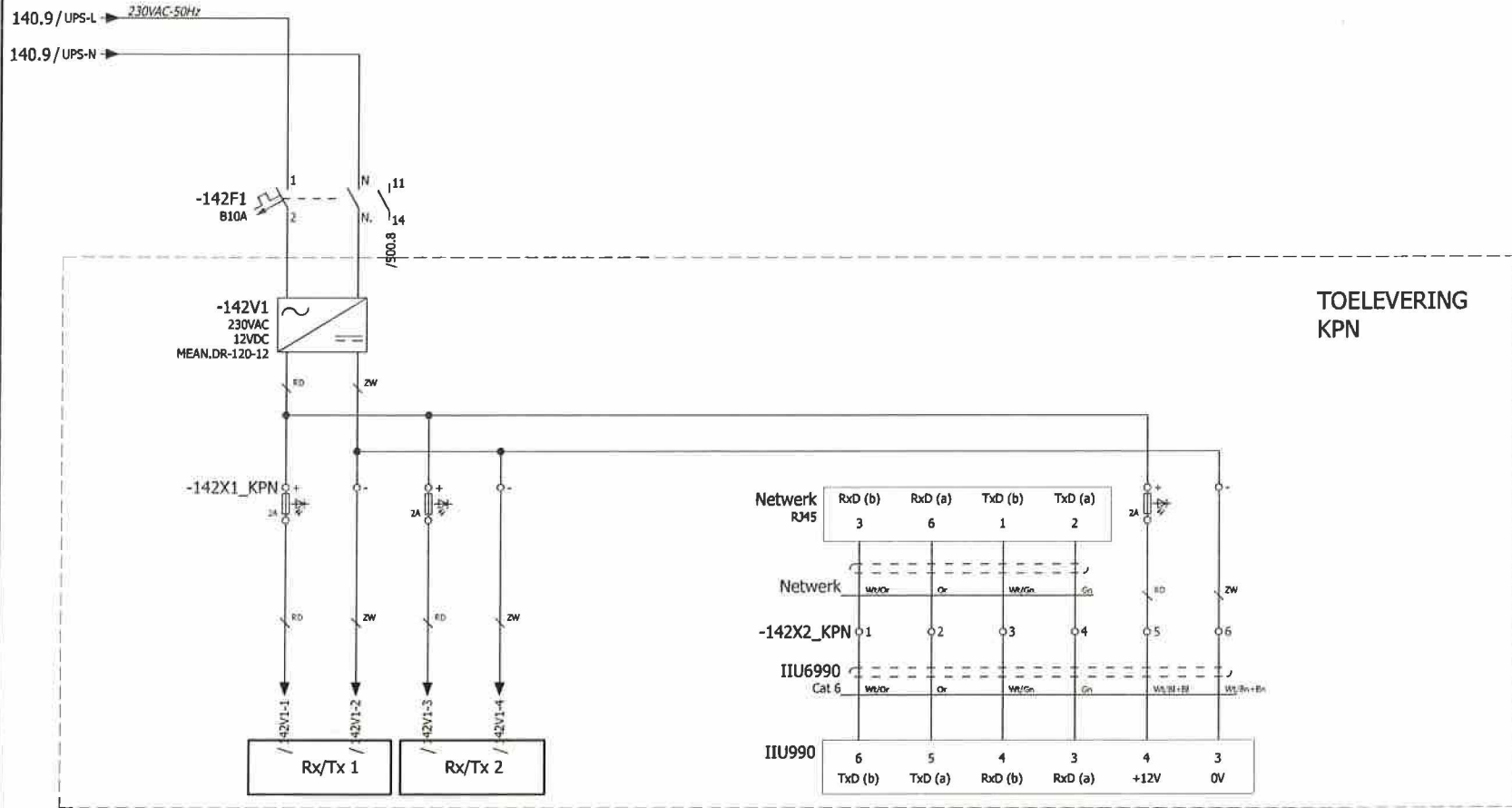

TOELEVERING
KPN

EXTERN

Datum	7-11-2014	Wijziging	Datum	Naam
Bew.				
Gecontr				

VOEDING 2
ETHERNETSWITCH

141.9/L → 230VAC-50Hz
141.9/N →

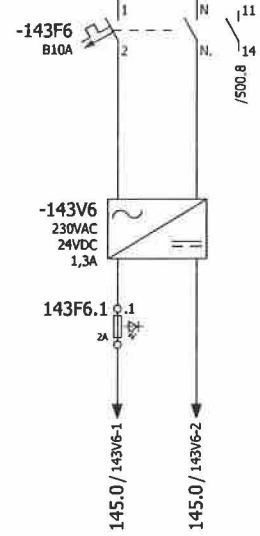

INTERN

EXTERN



Datum	7-11-2014	Wijziging	Datum	Naam
Bew.				
Gecontr				

Transmissiekast
Transmissiekast

HOOFDSTROOM 24VDC

=TK

A3	Schaal 1:1
Revisie	V1.0
Blad	143

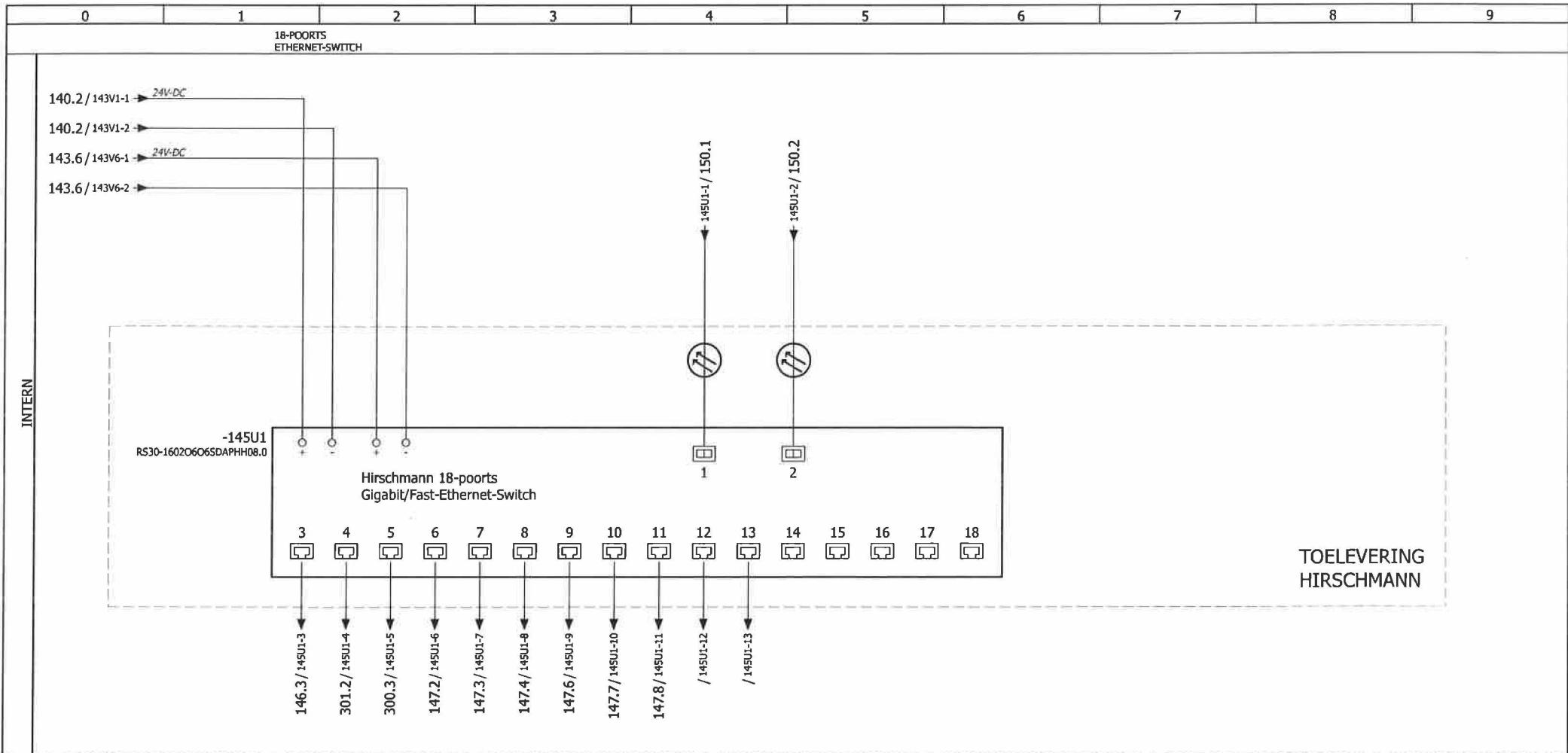

Datum	7-11-2014	Wijziging	Datum	Naam
Bew.				
Gecontr				

INTERN

EXTERN

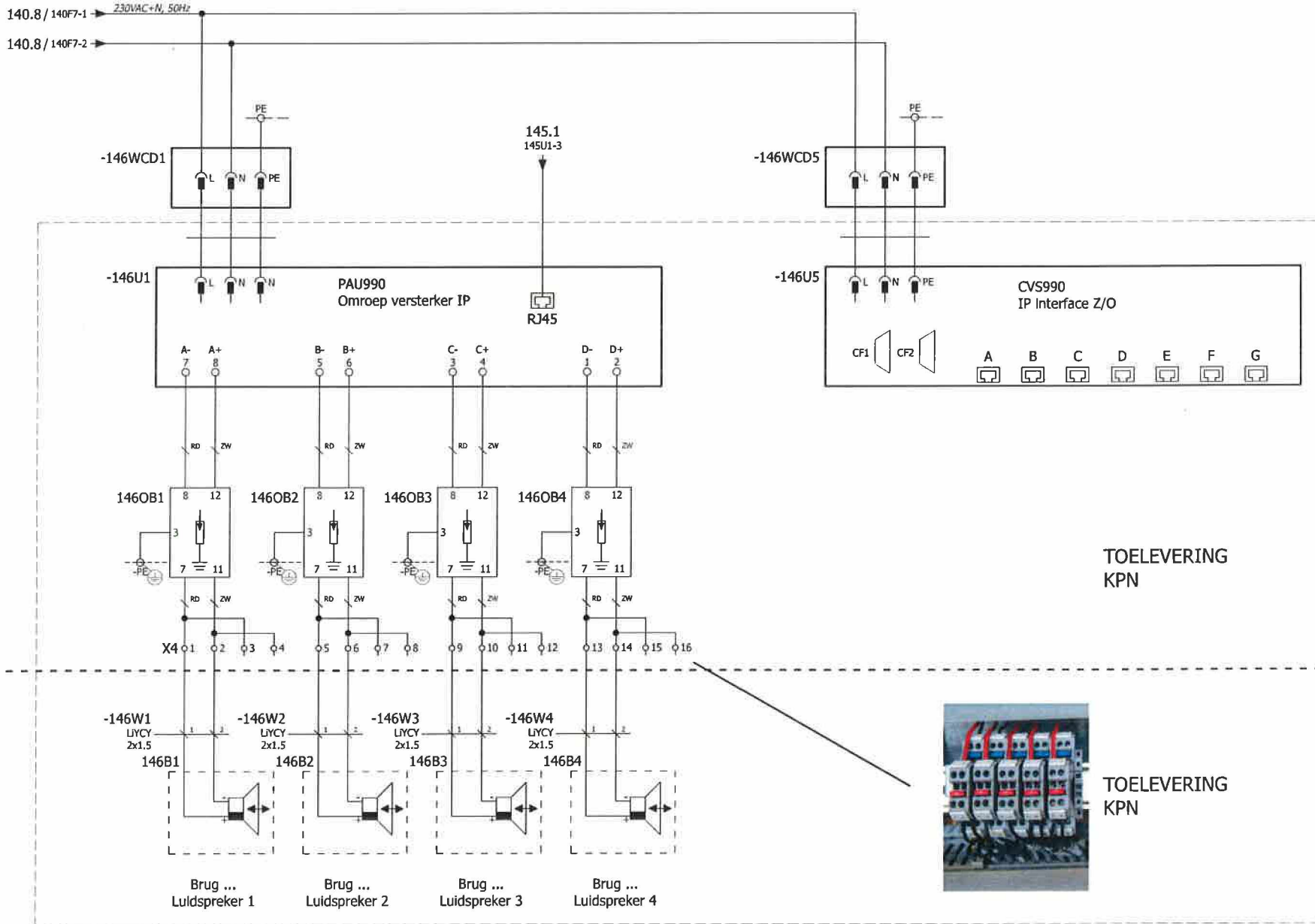

Datum	7-11-2014	Wijziging	Datum	Naam
Bew.				
Gecontr				

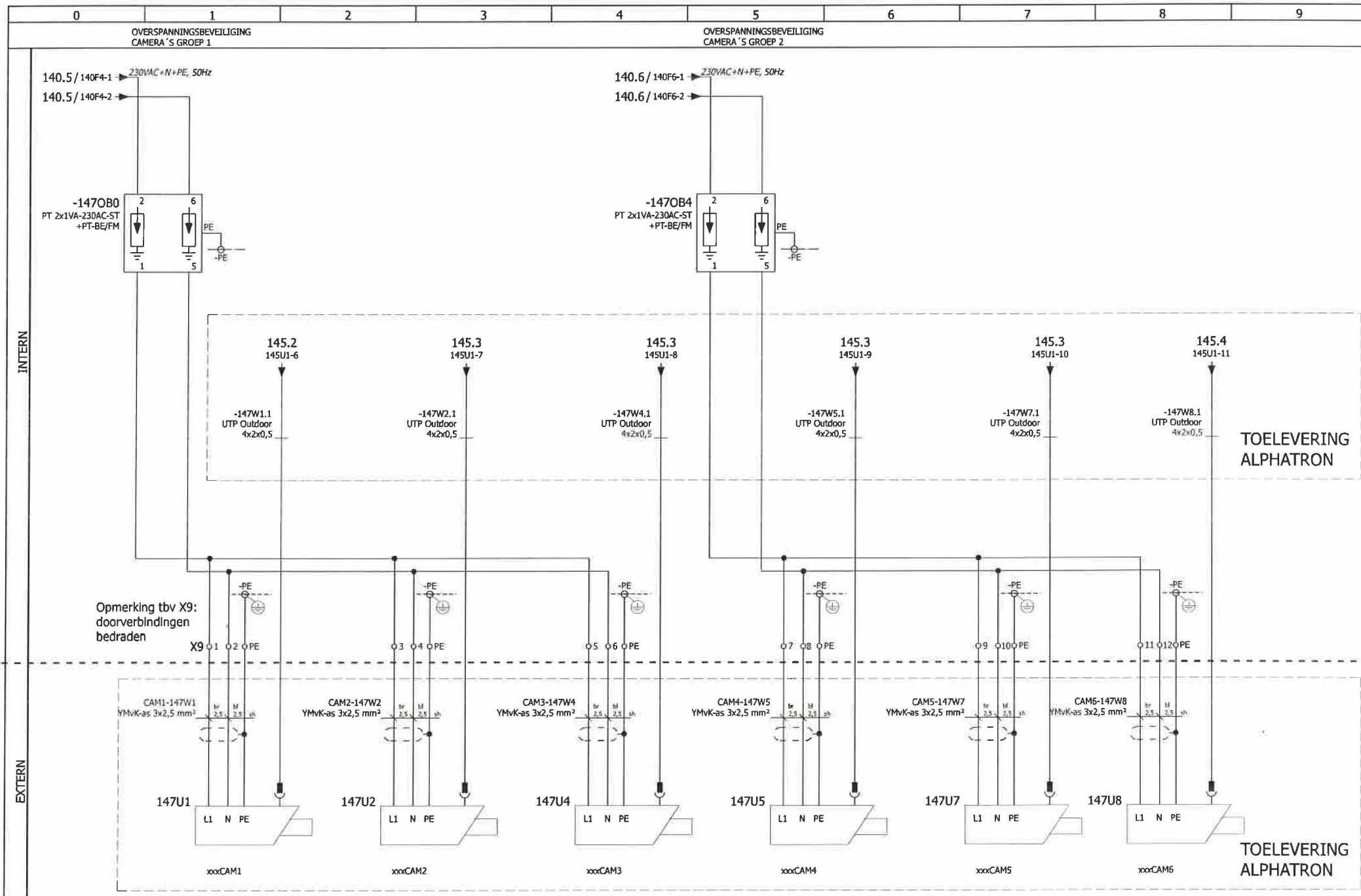

Datum	7-11-2014	Wijziging	Datum	Naam
Bew.				
Gecontr				

INTERN

EXTERN

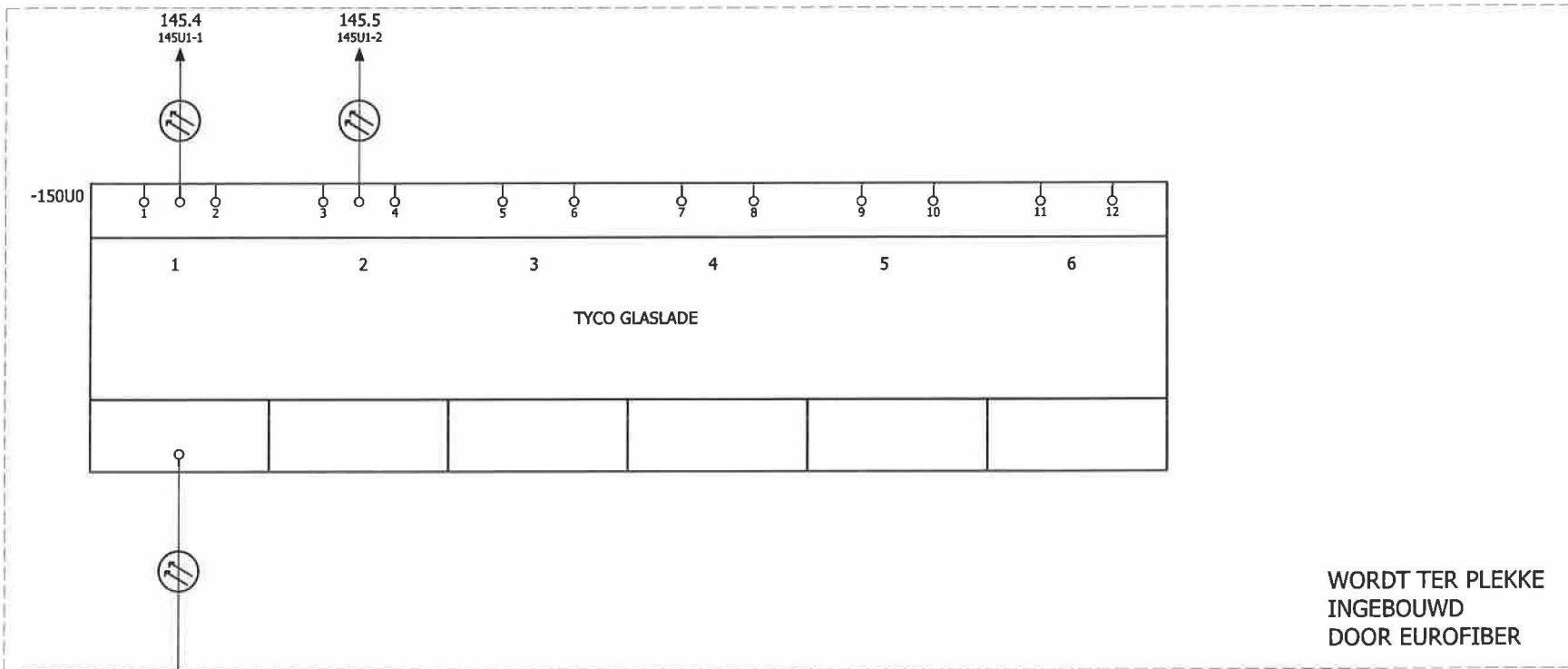

Datum	7-11-2014	Wijziging	Datum	Naam
Bew.				
Gecontr.				

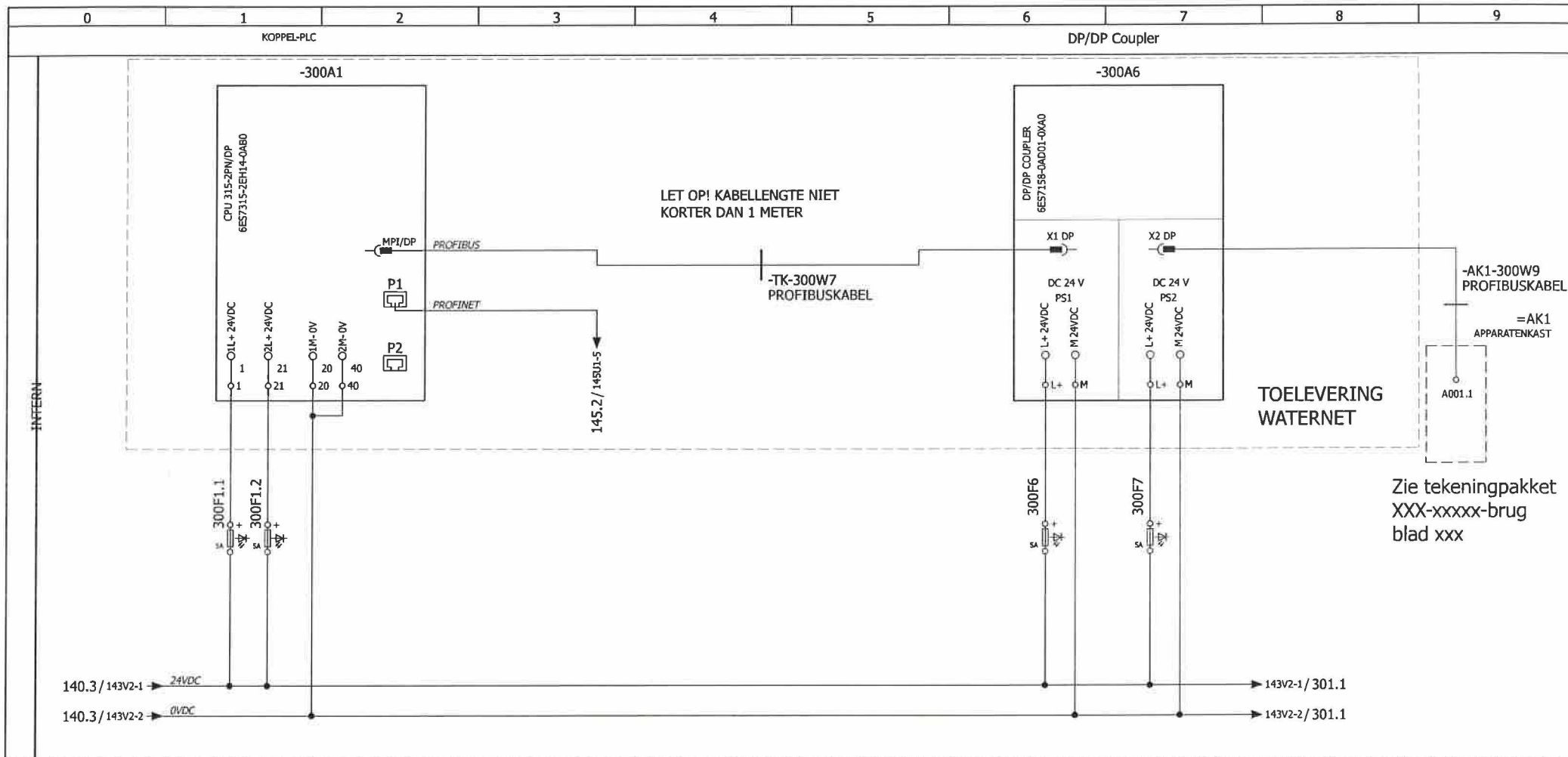

LET OP! KABELLENTE NIET KORTER DAN 1 METER

Zie tekeningpakket XXX-xxxxx-brug blad xxx

PROFIBUS
NAAR OBJECT PLC
IN BESTURINGSKAST
BSK01



Datum	7-11-2014	Wijziging	Datum	Naam
Bew.				
Gecontr				

Transmissiekast
Transmissiekast

PLC RACKINDELING KOPPEL-PLC
=TK

A3	Schaal 1:1
Revisie	V1.0
Blad	300

ET 200M

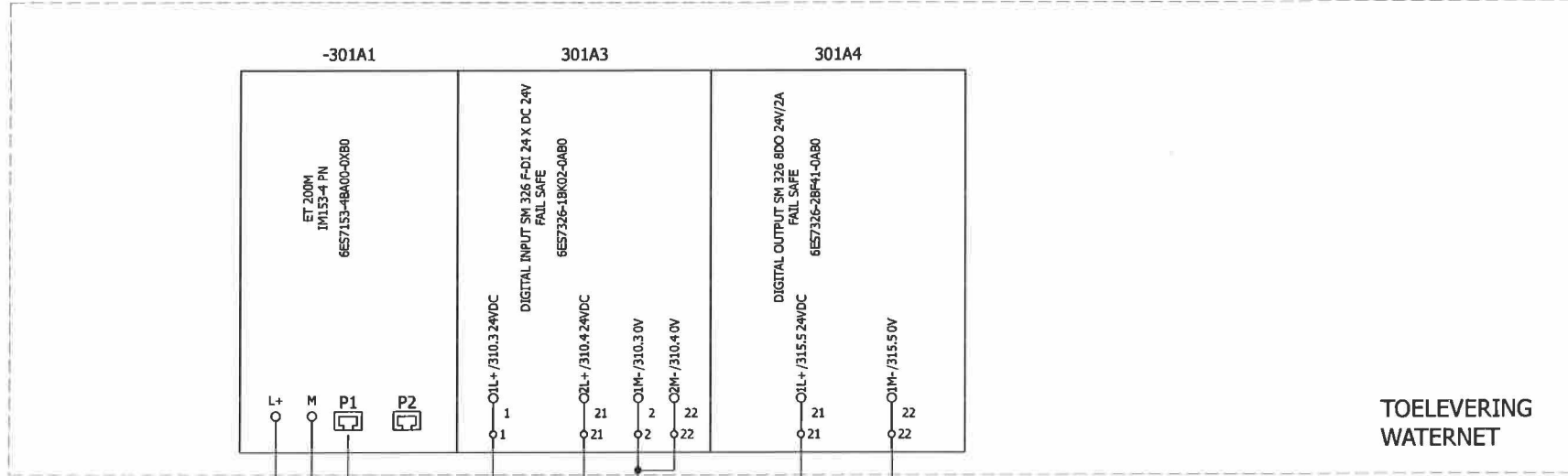

TOELEVERING
WATERNET

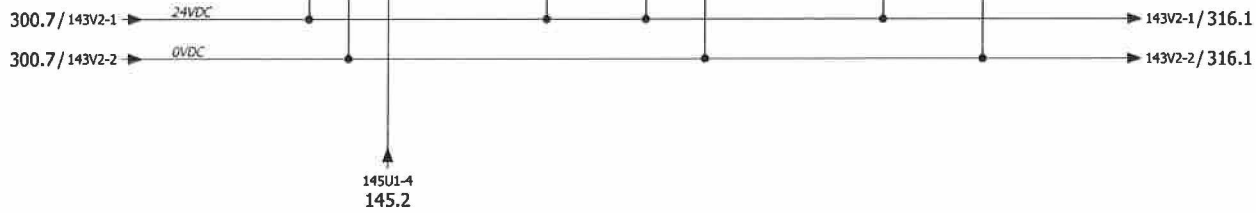

EXTERN

Datum	7-11-2014	Wijziging	Datum	Naam
Bew.				
Gecontr				

24VDC
 0V
 24VDC
 OBJECT IN RUST
 NOODSTOP EXTERN
 EXTERN VALIDATIE
 ALIVE
 RESERVE
 RESERVE

24VDC
 OBJECT IN RUST (OPTIE 2e NAUTISCH OBJECT)
 NOODSTOP EXTERN (OPTIE 2e NAUTISCH OBJECT)
 EXTERN VALIDATIE (OPTIE 2e NAUTISCH OBJECT)
 ALIVE (OPTIE 2e NAUTISCH OBJECT)
 RESERVE
 RESERVE

/301.3
 /301.4
 /311.0
 /311.2
 /311.3
 /311.4
 /311.5
 /311.6
 /311.7
 /312.0
 /312.2
 /312.3
 /312.4
 /312.5
 /312.6
 /312.7

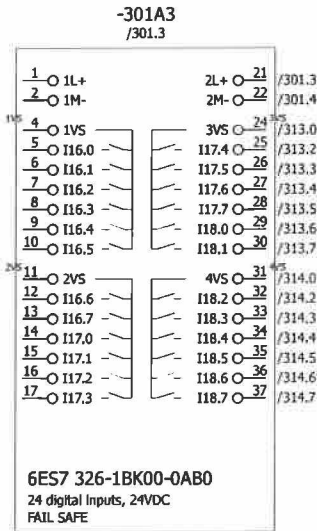

/301.3
 /301.4
 /313.0
 /313.2
 /313.3
 /313.4
 /313.5
 /313.6
 /313.7
 /314.0
 /314.2
 /314.3
 /314.4
 /314.5
 /314.6
 /314.7

24VDC
 0V
 24VDC
 RESERVE
 RESERVE
 RESERVE
 RESERVE
 RESERVE
 RESERVE
 24VDC
 RESERVE
 RESERVE
 RESERVE
 RESERVE
 RESERVE
 RESERVE

Datum	7-11-2014	Wijziging	Datum	Naam
Bew.				
Gecontr				

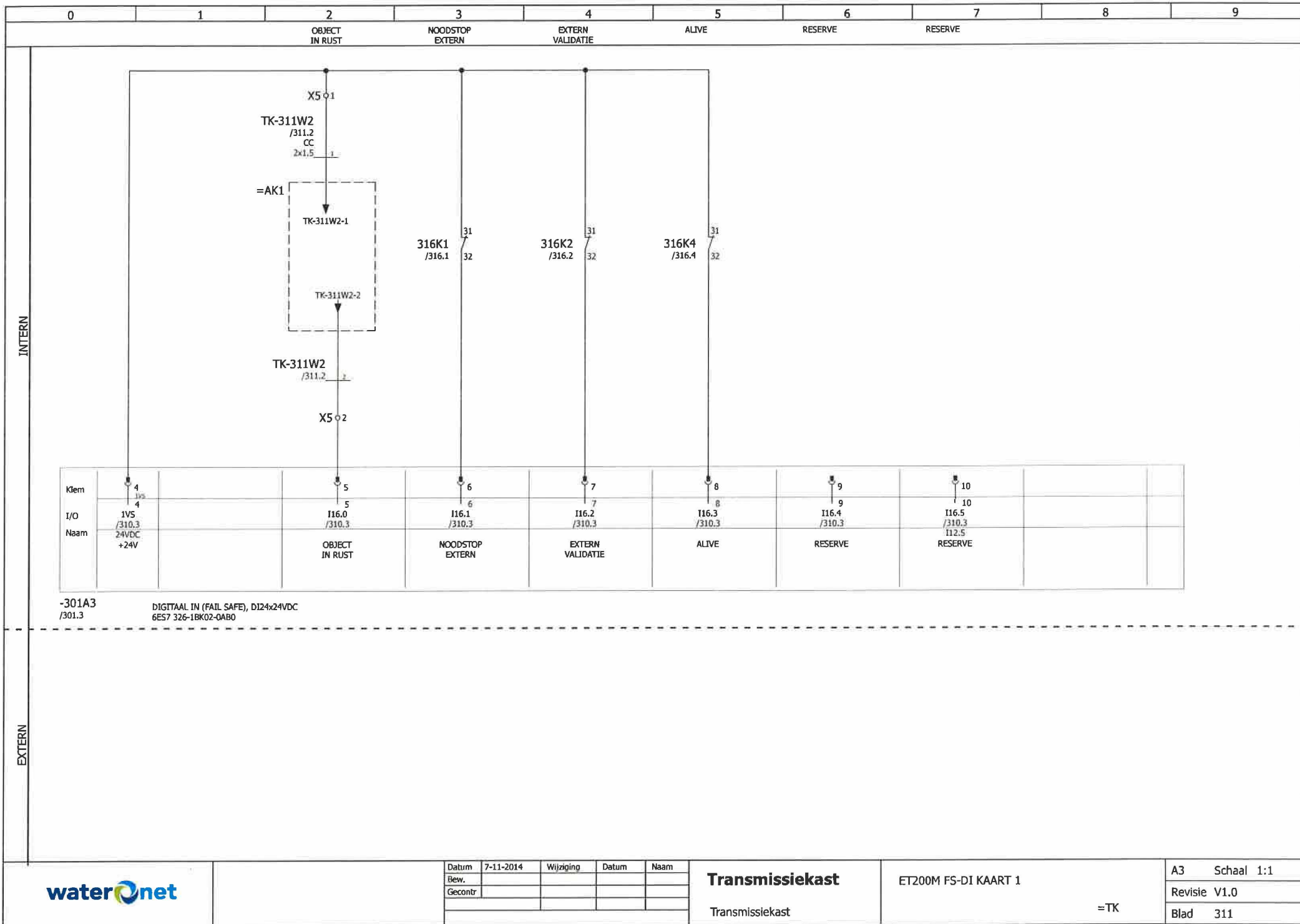

OBJECT IN RUST (OPTIE 2e NAUTISCH OBJECT)
 NOODSTOP EXTERN (OPTIE 2e NAUTISCH OBJECT)
 EXTERN VALIDATIE (OPTIE 2e NAUTISCH OBJECT)
 ALIVE (OPTIE 2e NAUTISCH OBJECT)
 RESERVE
 RESERVE

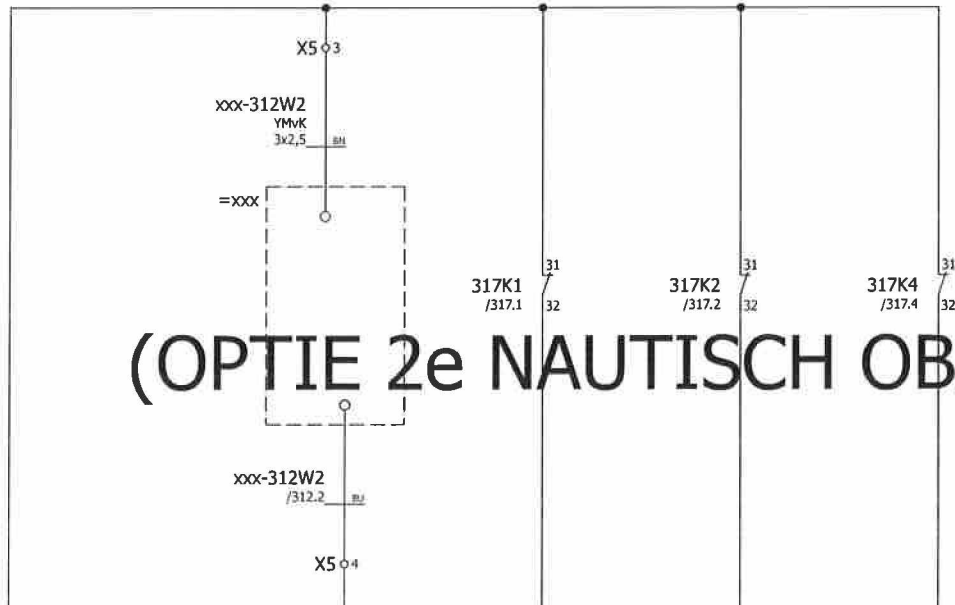

(OPTIE 2e NAUTISCH OBJECT)

Klem	11 <small>2V5</small>	12	13	14	15	16	17		
I/O	2V5 /310.3	I16.6 /310.3	I16.7 /310.3	I17.0 /310.3	I17.1 /310.3	I17.2 /310.3	I17.3 /310.3 I13.3		
Naam	24VDC +24V	OBJECT IN RUST (OPTIE 2e NAUTISCH OBJECT)	NOODSTOP EXTERN (OPTIE 2e NAUTISCH OBJECT)	EXTERN VALIDATIE (OPTIE 2e NAUTISCH OBJECT)	ALIVE (OPTIE 2e NAUTISCH OBJECT)	RESERVE	RESERVE		

-301A3 /301.3 DIGITAAL IN (FAIL SAFE), DI24x24VDC
6ES7 326-1BK00-0AB0

INTERN

EXTERN

RESERVE RESERVE RESERVE RESERVE RESERVE RESERVE

INTERN

Klem	24 <small>3VS</small>		25	26	27	28	29	30		
I/O	24 3VS /310.4		25 117.4 /310.4	26 117.5 /310.4	27 117.6 /310.4	28 117.7 /310.4	29 118.0 /310.4	30 118.1 /310.4		
Naam	24VDC +24V		RESERVE	RESERVE	RESERVE	RESERVE	RESERVE	114.1 RESERVE		

-301A3 DIGITAAL IN (FAIL SAFE), DI24x24VDC
/301.3 6ES7 326-1BK00-0AB0

EXTERN



Datum	7-11-2014	Wijziging	Datum	Naam
Bew.				
Gecontr				

Transmissiekast

ET200M FS-DI KAART 1

Transmissiekast

=TK

A3 Schaal 1:1

Revisie V1.0

Blad 313

RESERVE RESERVE RESERVE RESERVE RESERVE RESERVE

INTERN

Klem	31 <small>0/3</small>		32		33		34		35		36		37
I/O	4VS /310.4		I18.2 /310.4		I18.3 /310.4		I18.4 /310.4		I18.5 /310.4		I18.6 /310.4		I18.7 /310.4
Naam	24VDC +24V		RESERVE		RESERVE		RESERVE		RESERVE		RESERVE		I14.7 RESERVE

-301A3 DIGITAAL IN (FAIL SAFE), DI24x24VDC
/301.3 6ES7 326-1BK00-0AB0

EXTERN

Datum	7-11-2014	Wijziging	Datum	Naam
Bew.				
Gecontr				

301A4

NOODSTOP EXTERN

/316.1

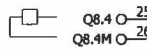
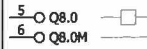

1L+ O 21 /301.4
1M- O 22 /301.5

24VDC
0V

NOODSTOP EXTERN (OPTIE 2e NAUTISCH OBJECT)

EXTERN VALIDATIE

/316.2

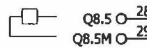
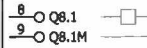

Q8.4 O 25 /317.1
Q8.4M O 26 /317.1

EXTERN VALIDATIE (OPTIE 2e NAUTISCH OBJECT)

ALIVE

/316.4

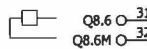
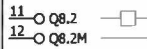

Q8.5 O 28 /317.2
Q8.5M O 29 /317.2

ALIVE (OPTIE 2e NAUTISCH OBJECT)

RESERVE

/316.5

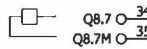
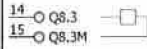

11 O Q8.2 /316.4
12 O Q8.2M /316.4

RESERVE

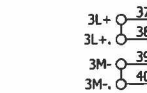

6ES7 326-2BF41-0AB0
8 digital outputs, 24VDC/2A
FAIL SAFE

Datum	7-11-2014	Wijziging		Datum		Naam	
Bew.							
Gecontr							

301A4
/301.4
DIGITAAL UIT (FAIL SAFE), DO8x24VDC/2A
6E57326-2BF41-0A80

Naam	NOODSTOP EXTERN	EXTERN VALIDATIE	ALIVE	RESERVE	24VDC	0V
I/O	/315.3 Q8.0 ₅	/315.3 Q8.1 ₈	/315.3 Q8.2 ₁₁	/315.3 Q8.3 ₁₄	2L+ 17	2M- 19
Klem	5	6	9	11	12	14
						15
						17
						18
						19
						20

INTERN

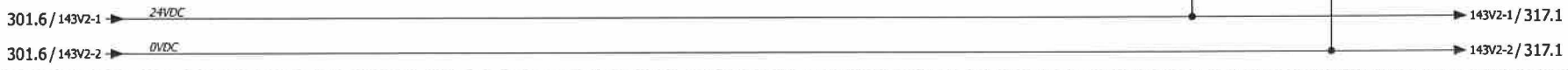
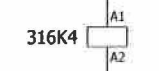
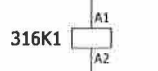

EXTERN

PSX_PSR-SCP-24DC/PSF/2X1/1X2
13 - 14 /500.1
23 - 24 /500.2
31 - 32 /311.3

PSX_PSR-SCP-24DC/PSF/2X1/1X2
13 - 14 /500.2
23 - 24 /500.3
31 - 32 /311.4

PSX_PSR-SCP-24DC/PSF/2X1/1X2
13 - 14 /500.4
23 - 24 /500.4
31 - 32 /311.5



Datum	7-11-2014	Wijziging	Datum	Naam
Bew.				
Gecontr.				

Transmissiekast
Transmissiekast

ET200M FS-DO KAART 1
NOODSTOP BRUG

=TK

A3	Schaal 1:1
Revisie	V1.0
Blad	316

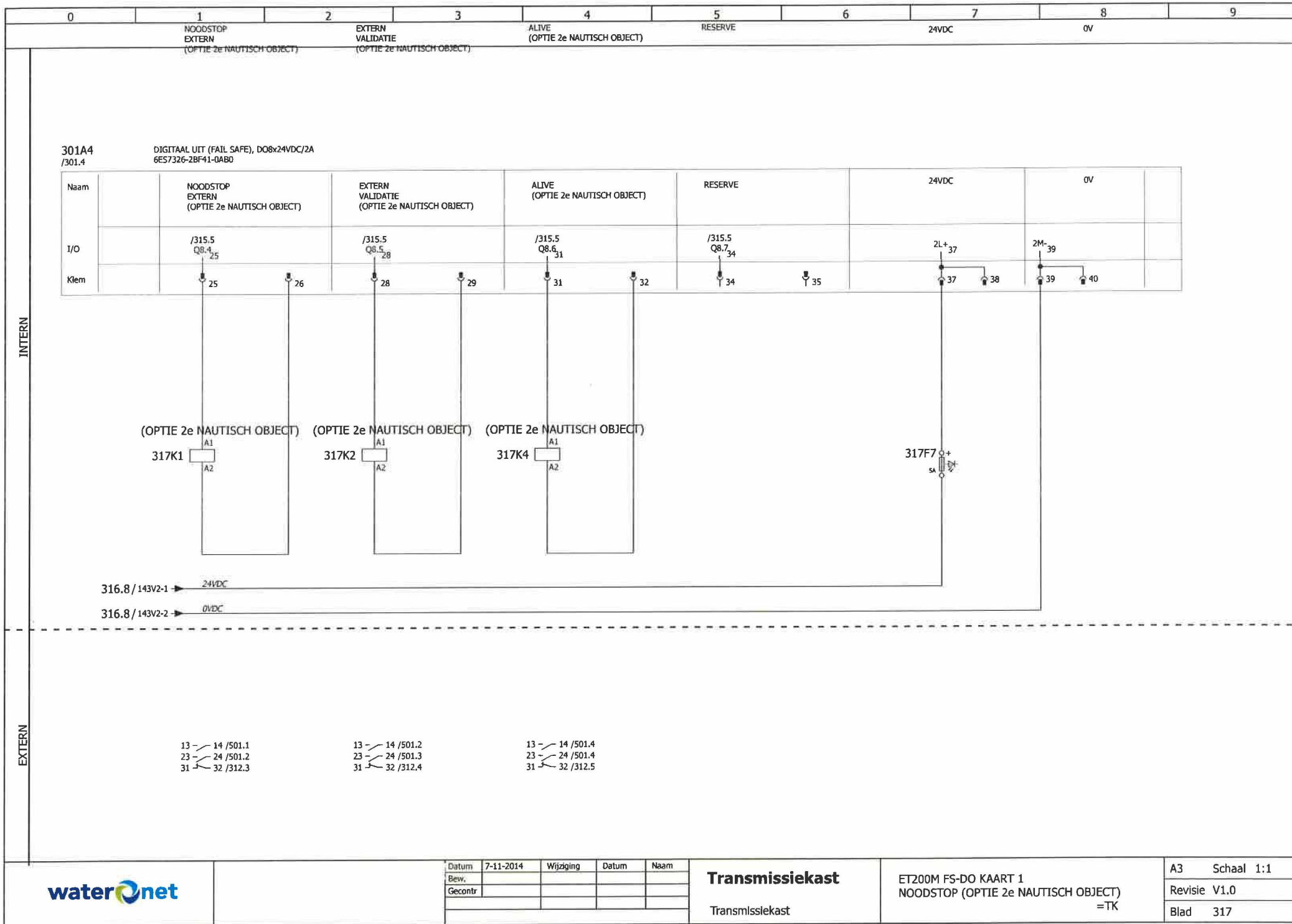

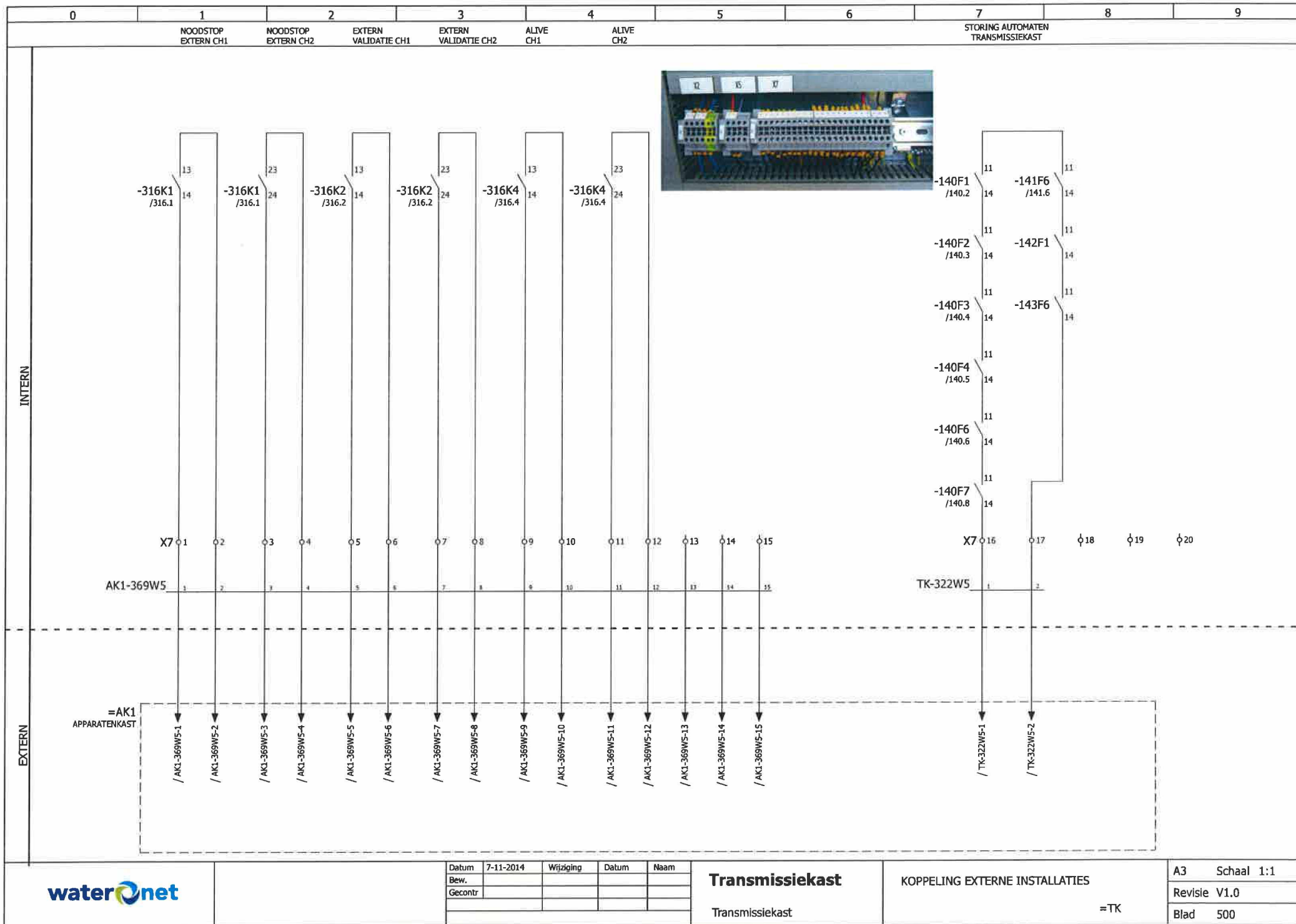

NOODSTOP EXTERN (OPTIE 2e NAUTISCH OBJECT)
 NOODSTOP EXTERN CH2 (OPTIE 2e NAUTISCH OBJECT)
 EXTERN VALIDATIE CH1 (OPTIE 2e NAUTISCH OBJECT)
 EXTERN VALIDATIE CH2 (OPTIE 2e NAUTISCH OBJECT)
 ALIVE CH1 (OPTIE 2e NAUTISCH OBJECT)
 ALIVE CH2 (OPTIE 2e NAUTISCH OBJECT)

INTERN

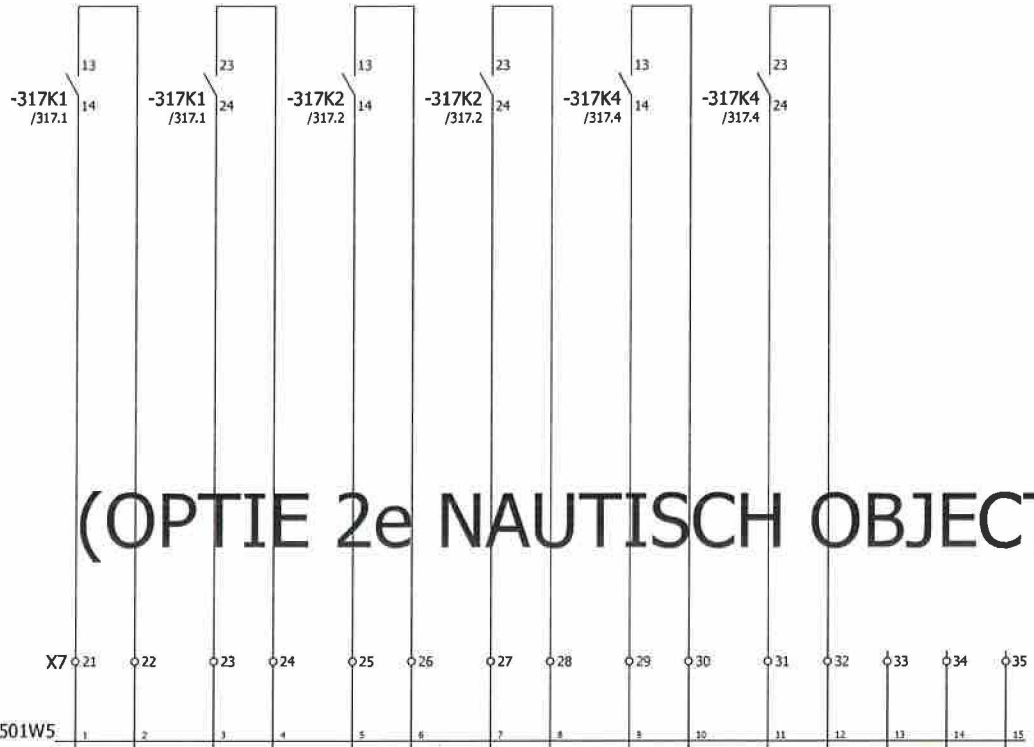

(OPTIE 2e NAUTISCH OBJECT)

EXTERN

=XXX APPARATENKAST



Datum	7-11-2014	Wijziging	Datum	Naam
Bew.				
Gecontr				

Transmissiekast
Transmissiekast

KOPPELING EXTERNE INSTALLATIES
(OPTIE 2e NAUTISCH OBJECT)

=TK

A3	Schaal 1:1
Revisie	V1.0
Blad	501

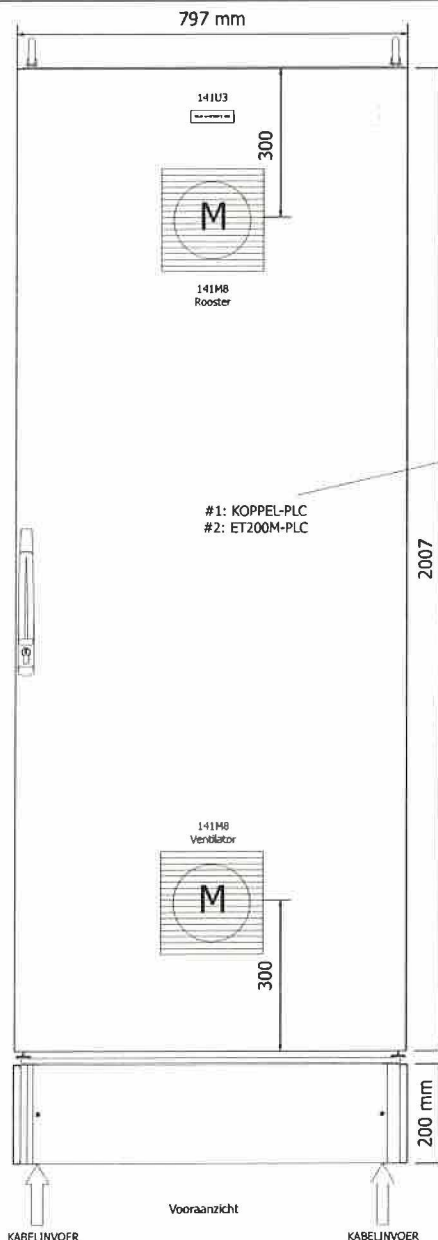

#1: KOPPEL-PLC
#2: ET200M-PLC

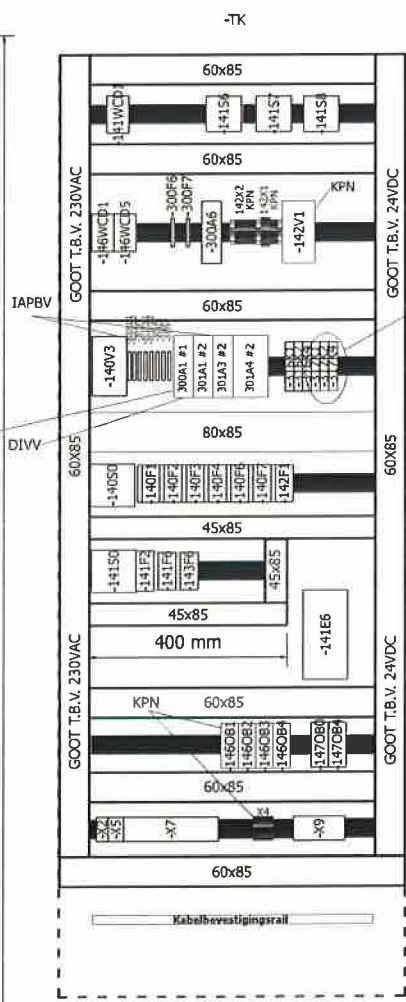

(Optie: 2x NAUTISCH OBJECT)

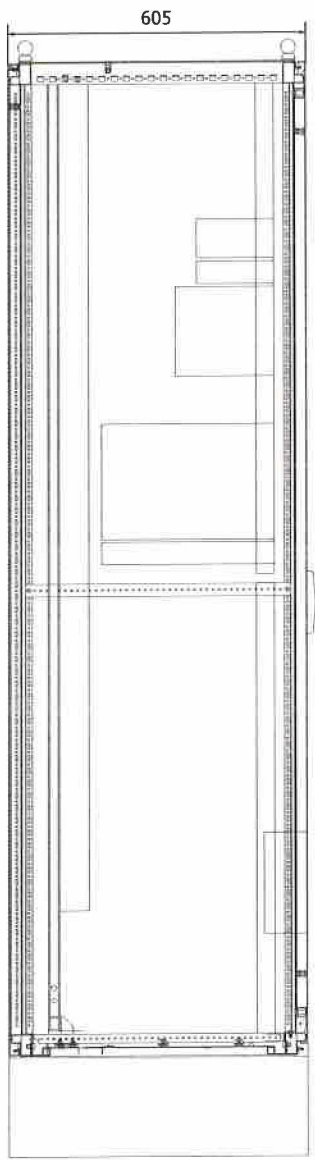
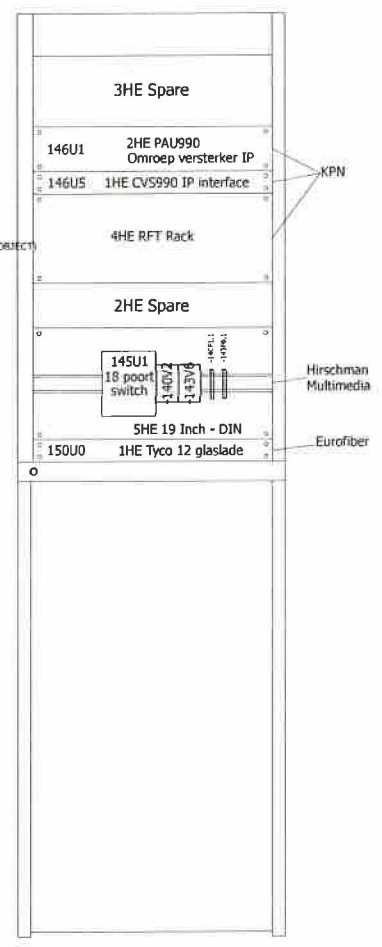

Montageplaat

Kast RAL7035	Rittal	TS 8806.500	1x
Zijwand RAL7035	Rittal	TS 8106.235	2x
Sokkel zijkant	Rittal	TS 8602.060	1x
Sokkel voor/achter	Rittal	TS 8602.800	1x
Kast RVS	Rittal	TS 8450.600	1x
Zijwand RVS	Rittal	TS 8700.060	2x
Sokkel zijkant RVS	Rittal	TS 8702.060	1x
Sokkel voor/achter RVS	Rittal	TS 8702.800	1x
Tekeninghouder	Rittal	4116.500	1x
Handgreep	Rittal	8611.070	1x
Profielcylinder	Rittal	9785.040	1x
Deurarretering	Rittal	4583.000	1x
Kabelbev. rail	Rittal	4192.000	1x

Keuze:
RAL7035
of
RVS

19" Zwenkraam

19" draaiframe 18HE	Rittal	SR 2377.180	1x
19" inbouwset	Rittal	SR 2377.880	1x
Kabelslang	Rittal	SZ 2590.000	1x
Kabelslanghouder	Rittal	SZ 2592.000	4x

230VAC EN 24VDC SCHEIDEN

Opmerking algemeen:
- Bedrading voor 230Vac zoveel mogelijk LINKS in de bedradingskokers
- Bedrading voor overige signalen zoveel mogelijk RECHTS in de bedradingskokers.

Datum	7-11-2014	Wijziging	Datum	Naam
Bew.				
Gecontr.				

Klemmenaansluitlijst

Watermet_klemmenaansluitlijst

Kabelnaam		Doelcode	Aansluiting	Klem	Brug	Doelcode	Aansluiting	Kabelnaam
146W4	LYCY							
1	146W1	-146B1	+	1	•	-146OB1	7	
2	146W2	-146B1	-	2	•	-146OB1	11	
				3	•			
				4	•			
				5	•	-146B2	7	
				6	•	-146OB2	11	
				7	•			
				8	•			
				9	•	-146B3	7	
				10	•	-146OB3	11	
				11	•			
				12	•			
				13	•	-146B4	7	
				14	•	-146OB4	11	
				15	•			
				16	•			



Datum	7-11-2014	Wijziging	Datum	Naam
Bew.				
Gecontr				

Transmissiekast

Transmissiekast

Klemmenaansluitlijst =TK-X4

=TK

A3	Schaal 1:1
Revisie	V1.0
Blad	601

Klemmenaansluitlijst

Watemet_klemmenaansluitlijst

Kabelnaam		Stroom =TK-X7					Kabelnaam	
Doelcode	Aansluiting	Klem	Brug	Doelcode	Aansluiting			
		1		-316K1	14			
		2		-316K1	13			
		3		-316K1	24			
		4		-316K1	23			
		5		-316K2	14			
		6		-316K2	13			
		7		-316K2	24			
		8		-316K2	23			
		9		-316K4	14			
		10		-316K4	13			
		11		-316K4	24			
		12		-316K4	23			
		13						
		14						
		15						
		16		-140F7	14			
		17		-143F6	14			
		18						
		19						
		20						
		21		-317K1	14			
		22		-317K1	13			
		23		-317K1	24			
		24		-317K1	23			
		25		-317K2	14			
		26		-317K2	13			
		27		-317K2	24			
		28		-317K2	23			
		29		-317K4	14			
		30		-317K4	13			
		31		-317K4	24			
		32		-317K4	23			
		33						
		34						
		35						



Datum	7-11-2014	Wijziging	Datum	Naam
Bew.				
Gecontr				

Transmissiekast

Transmissiekast

Klemmenaansluitlijst =TK-X7

=TK

A3	Schaal 1:1
	Revisie V1.0
Blad	603

Artikellijst

Onderdeelcode	Aantal	Omschrijving	Typenummer	Fabrikant	Leverancier	Artikelnummer
-140F1	1	Automaat IC60N 10kA 1P+N B10A	A9F78610	Schneider Electric	Schneider Electric	SE.A9F78610
-140F1	1	Hulpcontact automaat	A9A26924	Schneider Electric	Schneider Electric	SE.A9A26924
-140F1.1	1	Scheidingshendel-zekeringsklem met LED-indicatie	UT4-HESILED 24-P/P	Phoenix Contact B.V.	Cito Benelux	3046540
-140F1.1	1		Glas fuse 5x20mm 2A			Glas fuse 5x20mm 2A
-140F2	1	Automaat IC60N 10kA 1P+N B10A	A9F78610	Schneider Electric	Schneider Electric	SE.A9F78610
-140F2	1	Hulpcontact automaat	A9A26924	Schneider Electric	Schneider Electric	SE.A9A26924
-140F3	1	Automaat IC60N 10kA 1P+N B10A	A9F78610	Schneider Electric	Schneider Electric	SE.A9F78610
-140F3	1	Hulpcontact automaat	A9A26924	Schneider Electric	Schneider Electric	SE.A9A26924
-140F4	1	Automaat IC60N 10kA 1P+N B10A	A9F78610	Schneider Electric	Schneider Electric	SE.A9F78610
-140F4	1	Hulpcontact automaat	A9A26924	Schneider Electric	Schneider Electric	SE.A9A26924
-140F6	1	Automaat IC60N 10kA 1P+N B10A	A9F78610	Schneider Electric	Schneider Electric	SE.A9F78610
-140F6	1	Hulpcontact automaat	A9A26924	Schneider Electric	Schneider Electric	SE.A9A26924
-140F7	1	Automaat IC60N 10kA 1P+N B10A	A9F78610	Schneider Electric	Schneider Electric	SE.A9F78610
-140F7	1	Hulpcontact automaat	A9A26924	Schneider Electric	Schneider Electric	SE.A9A26924
-140S0	1	Hoofdschakelaar 3P 40A	28900	Schneider Electric	Schneider Electric	SE.28900
-140V2	1	24VDC DIN RAIL VOEDING	RPS30	HIRSCHMANN	HIRSCHMANN	HIR.RPS30
-140V3	1	STOP PSU100L 24V/10A GESTABILISEERDE VOEDING	6EP1334-1L800	Siemens	Siemens	SIE.6EP1334-1L800
-141E6	1	Kastverwarming 150W	SK 3105.370	RITTAL	RITTAL	RIT.SK 3105.370
-141F2	1	iDPNa Vigi aardlekautomaat 1P+N 10 A B-kar	A9D54610	Schneider Electric	Schneider Electric	SE.A9D54610
-141F6	1	Automaat IC60N 10kA 1P+N B10A	A9F78610	Schneider Electric	Schneider Electric	SE.A9F78610
-141F6	1	Hulpcontact automaat	A9A26924	Schneider Electric	Schneider Electric	SE.A9A26924
-141M8	1	Ventilator 105/120 m3/h	SK 3239.100	RITTAL	RITTAL	RIT.SK 3239.100
-141M8	1	Ventilatorooster	SK 3239.200	RITTAL	RITTAL	RIT.SK 3239.200
-141S0	1	Hoofdschakelaar 3P 40A	28900	Schneider Electric	Schneider Electric	SE.28900
-141S6	1	Thermostaat	SK 3100.000	RITTAL	RITTAL	RIT.SK 3110.000
-141S7	1	Hygrostaal	SK 3118.000	RITTAL	RITTAL	RIT.SK 3118.000
-141S8	1	Thermostaal	SK 3100.000	RITTAL	RITTAL	RIT.SK 3110.000
-141U3	1	Standard light with door-operated switch 18 W/ 230V	SZ 4138.190	RITTAL	RITTAL	RIT.SZ 4138.190
-141U3	3	Verlichting 14W met WCD en deurschakelaar	SZ 4138.150	RITTAL	RITTAL	RIT.SZ 4138.150
-141WCD1	1	Wandcontactdoos voor railmontage	SD-D/SC	Phoenix Contact B.V.	Phoenix Contact B.V.	PHO.2963310
-142F1	1	Automaat IC60N 10kA 1P+N B10A	A9F78610	Schneider Electric	Schneider Electric	SE.A9F78610
-142F1	1	Hulpcontact automaat	A9A26924	Schneider Electric	Schneider Electric	SE.A9A26924
-143F6	1	Automaat IC60N 10kA 1P+N B10A	A9F78610	Schneider Electric	Schneider Electric	SE.A9F78610
-143F6.1	1	Scheidingshendel-zekeringsklem met LED-indicatie	UT4-HESILED 24-P/P	Phoenix Contact B.V.	Cito Benelux	3046540
-143F6.1	1		Glas fuse 5x20mm 2A			Glas fuse 5x20mm 2A
-143V6	1	24VDC DIN RAIL VOEDING	RPS30	HIRSCHMANN	HIRSCHMANN	HIR.RPS30
-146WCD1	1	Wandcontactdoos voor railmontage	SD-D/SP/GY	Phoenix Contact B.V.	Phoenix Contact B.V.	PHO.2963501
-146WCD5	1	Wandcontactdoos voor railmontage	SD-D/SP/GY	Phoenix Contact B.V.	Phoenix Contact B.V.	PHO.2963501
-1470B0	1	Overspanningsbeveiliging voor eenfase voeding	PT 2X1VA-230AC-ST	Phoenix Contact B.V.	Phoenix Contact B.V.	PHOE.2839198
-1470B0	1	Voetje voor overspanningsbeveiliging	PT-BE/FM	Phoenix Contact B.V.	Cito Benelux	PHOE.2839282
-1470B4	1	Overspanningsbeveiliging voor eenfase voeding	PT 2X1VA-230AC-ST	Phoenix Contact B.V.	Phoenix Contact B.V.	PHOE.2839198
-1470B4	1	Voetje voor overspanningsbeveiliging	PT-BE/FM	Phoenix Contact B.V.	Cito Benelux	PHOE.2839282
-300A6	1	Digitale Ingangkaart 32-voudig	6ES7 321-1BL00-0AA0	Siemens	Siemens	6ES7 321-1BL00-0AA0
-300F1.1	1	Scheidingshendel-zekeringsklem met LED-indicatie	UT4-HESILED 24-P/P	Phoenix Contact B.V.	Cito Benelux	3046540
-300F1.1	1		Glas fuse 5x20mm 5A			Glas fuse 5x20mm 5A
-300F1.2	1	Scheidingshendel-zekeringsklem met LED-indicatie	UT4-HESILED 24-P/P	Phoenix Contact B.V.	Cito Benelux	3046540
-300F1.2	1		Glas fuse 5x20mm 5A			Glas fuse 5x20mm 5A
-300F6	1	Scheidingshendel-zekeringsklem met LED-indicatie	UT4-HESILED 24-P/P	Phoenix Contact B.V.	Cito Benelux	3046540
-300F6	1		Glas fuse 5x20mm 5A			Glas fuse 5x20mm 5A
-300F7	1	Scheidingshendel-zekeringsklem met LED-indicatie	UT4-HESILED 24-P/P	Phoenix Contact B.V.	Cito Benelux	3046540
-300F7	1		Glas fuse 5x20mm 5A			Glas fuse 5x20mm 5A
-301F1	1	Scheidingshendel-zekeringsklem met LED-indicatie	UT4-HESILED 24-P/P	Phoenix Contact B.V.	Cito Benelux	3046540
-301F1	1		Glas fuse 5x20mm 5A			Glas fuse 5x20mm 5A
-301F3.1	1	Scheidingshendel-zekeringsklem met LED-indicatie	UT4-HESILED 24-P/P	Phoenix Contact B.V.	Cito Benelux	3046540
-301F3.1	1		Glas fuse 5x20mm 5A			Glas fuse 5x20mm 5A
-301F3.2	1	Scheidingshendel-zekeringsklem met LED-indicatie	UT4-HESILED 24-P/P	Phoenix Contact B.V.	Cito Benelux	3046540



Datum Bew.	7-11-2014	Wijziging	Datum	Naam
Gecontr				

Transmissiekast

MATERIAALLIJST

Transmissiekast

=TK

A3 Schaal 1:1

Revisie V1.0

Blad 800

Artikellijst

Onderdeelcode	Aantal	Omschrijving	Typenummer	Fabrikant	Leverancier	Artikelnummer
-301F3.2	1		Glas fuse 5x20mm 5A			Glas fuse 5x20mm 5A
-301F4	1	Scheidingshendel-zekeringsklem met LED-indicatie	UT4-HESILED 24-P/P	Phoenix Contact B.V.	Cito Benelux	3046540
-301F4	1		Glas fuse 5x20mm 5A			Glas fuse 5x20mm 5A
-316F7	1	Scheidingshendel-zekeringsklem met LED-indicatie	UT4-HESILED 24-P/P	Phoenix Contact B.V.	Cito Benelux	3046540
-316F7	1		Glas fuse 5x20mm 5A			Glas fuse 5x20mm 5A
-316K1	1	SIL3 koppelings relais	PSR-SCP-24DC/FSP/2X1/1X2	PHOENIX	PHOENIX	PSX.PSR-SCP-24DC/FSP/2X1/1X2
-316K2	1	SIL3 koppelings relais	PSR-SCP-24DC/FSP/2X1/1X2	PHOENIX	PHOENIX	PSX.PSR-SCP-24DC/FSP/2X1/1X2
-316K4	1	SIL3 koppelings relais	PSR-SCP-24DC/FSP/2X1/1X2	PHOENIX	PHOENIX	PSX.PSR-SCP-24DC/FSP/2X1/1X2
-317F7	1	Scheidingshendel-zekeringsklem met LED-indicatie	UT4-HESILED 24-P/P	Phoenix Contact B.V.	Cito Benelux	3046540
-317F7	1		Glas fuse 5x20mm 5A			Glas fuse 5x20mm 5A
-TK_ALG	1	Montagebeugel voor DIN-rail schuin	2366.000	RITTAL	RITTAL	RIT.2366.000
-TK_ALG	1	Tekeninghouder plaatstaal, diepte 35mm	4116.500	RITTAL	RITTAL	RIT.4116.500
-TK_ALG	1	Enkele profielcilinder, incl. 3 sleutels	9785.040	RITTAL	RITTAL	RIT.9785.040
-TK_ALG	1	Deurarmeuring	4583.000	RITTAL	RITTAL	RIT.4583.000
-TK_ALG	1	19" Draaiframe 18HE	SR 2377.180	RITTAL	RITTAL	RIT.SR 2377.180
-TK_ALG	1	Inbouwset t.b.v. 19" zwaairaam	SR 2377.880	RITTAL	RITTAL	RIT.SR 2377.880
-TK_ALG	1	Kabelbevestigingsrail, kastbreedte 800mm	4192.000	RITTAL	RITTAL	RIT.4192.000
-TK_ALG	1	Kabelslang, doorsnede 48mm	2590.000	RITTAL	RITTAL	RIT.2590.000
-TK_ALG	2	Kabelslanghouder voor slangdoorsnede 48mm	2592.000	RITTAL	RITTAL	RIT.2592.000
-TK_RAL7035	1	TS8 kast BxHxD 800x2000x600	TS 8806.500	RITTAL	RITTAL	RIT.TS 8806.500
-TK_RAL7035	2	Zijwand 2000hoog 600diep	TS 8106.235	RITTAL	RITTAL	RIT.TS 8106.235
-TK_RAL7035	1	Sokkel zijkant 600mm diepe kast 200mm hoog	TS 8602.060	RITTAL	RITTAL	RIT.TS 8602.060
-TK_RAL7035	1	Sokkel voor achter 200mm hoog	TS 8602.800	RITTAL	RITTAL	RIT.TS 8602.800
-TK_RAL7035	1	Comfort handgreep voor enkele profielcilinder RAL7035	8611.070	RITTAL	RITTAL	RIT.8611.070
-TK_RVS	1	TS8 kast RVS BxHxD 800x2000x600	TS 8450.600	RITTAL	RITTAL	RIT.TS 8450.600
-TK_RVS	2	Zijwand RVS 2000hoog 600diep	TS 8700.060	RITTAL	RITTAL	RIT.TS 8700.060
-TK_RVS	1	Sokkel RVS zijkant 600mm diepe kast 200mm hoog	TS 8702.060	RITTAL	RITTAL	RIT.TS 8702.060
-TK_RVS	1	Sokkel RVS voor achter 200mm hoog	TS 8702.800	RITTAL	RITTAL	RIT.TS 8702.800
-TK_RVS	1	Comfort handgreep Mat Vernikkeld voor enkele profielcilinder	8611.340	RITTAL	RITTAL	RIT.8611.340
-X2	1	Eindsteun	CLIPFIX 35-5	Phoenix Contact B.V.	Cito Benelux	3022276
-X2	2	Aansluitklem	UT4	Phoenix Contact B.V.	Cito Benelux	3044102
-X2	1	Universele Aardklem	UT 4-PE	Phoenix Contact B.V.	Cito Benelux	3044128
-X5	2	Eindsteun	CLIPFIX 35-5	Phoenix Contact B.V.	Cito Benelux	3022276
-X5	1	Eindplaat UT klemmen	D-UT 2,5/10	Phoenix Contact B.V.	Cito Benelux	3047028
-X5	4	Aansluitklem	UT2,5	Phoenix Contact B.V.	Cito Benelux	3044076
-X7	2	Eindsteun	CLIPFIX 35-5	Phoenix Contact B.V.	Cito Benelux	3022276
-X7	1	Eindplaat UT klemmen	D-UT 2,5/10	Phoenix Contact B.V.	Cito Benelux	3047028
-X7	35	Aansluitklem	UT2,5	Phoenix Contact B.V.	Cito Benelux	3044076
-X9	2	Eindsteun	CLIPFIX 35-5	Phoenix Contact B.V.	Cito Benelux	3022276
-X9	1	Eindplaat UT klemmen	D-UT 2,5/10	Phoenix Contact B.V.	Cito Benelux	3047028
-X9	12	Aansluitklem	UT2,5	Phoenix Contact B.V.	Cito Benelux	3044076
-X9	6	Universele Aardklem	UT 2,5-PE	Phoenix Contact B.V.	Cito Benelux	3044092