

Bijlage 1 - Detaillering

Hoogtemaatvoering onderlinge objecten

Voetpad-Fietspad

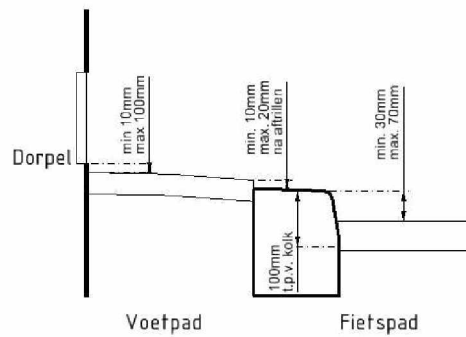

Voetpad-Rijbaan/Parkeerstrook

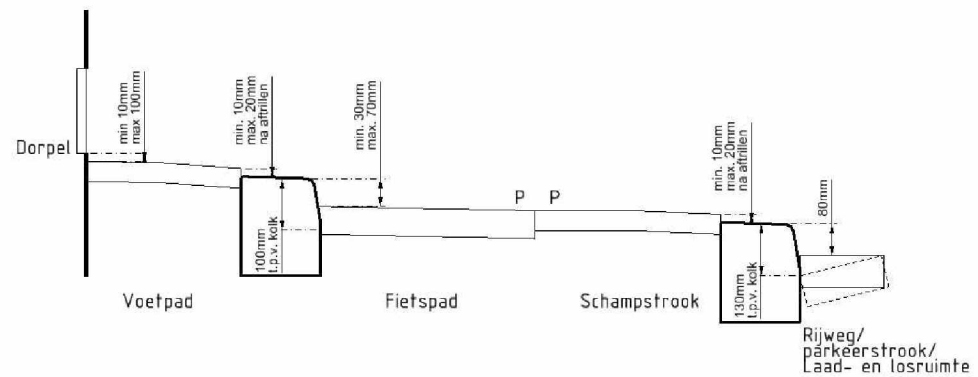

Voetpad-Fietspad-Schampstrook-Rijbaan/Parkeerstrook

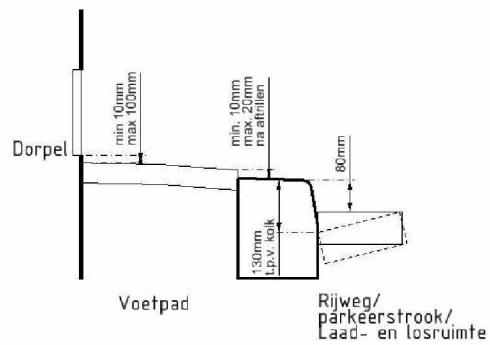

Niet bereden dek

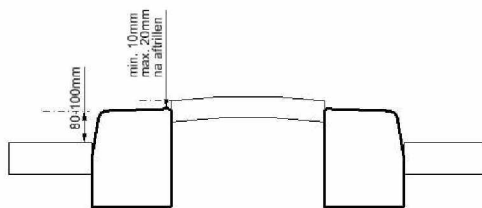

Fundering

Aanbrengen fundering

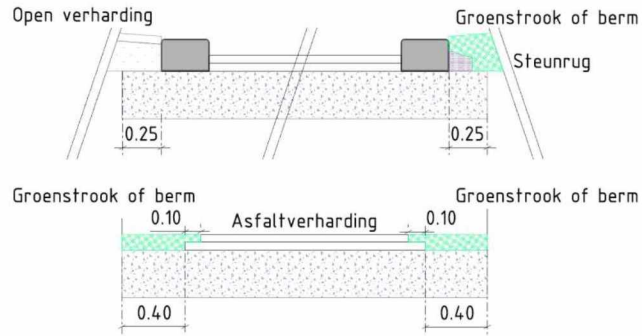

Passtukken

Banden

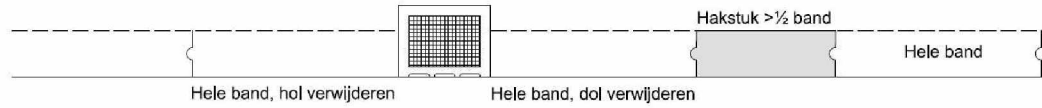

Invlechtingen

Voetpad tegels

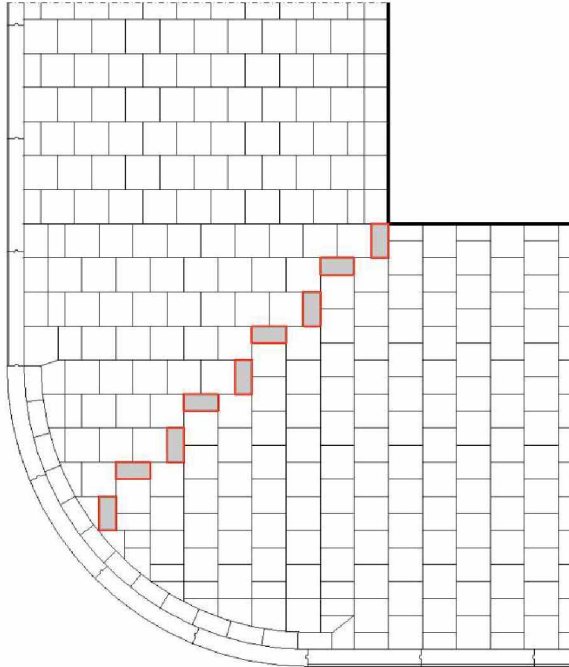

Indien haklaag nodig, deze 10 lagen voor de hoek aanbrengen

Rijweg, invlechting

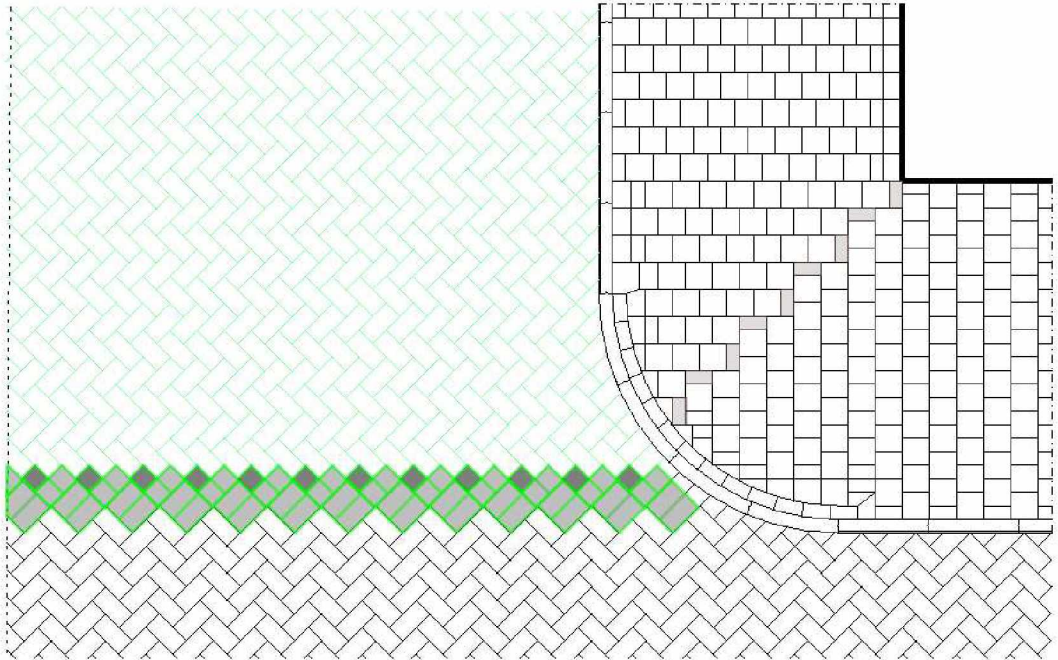

Rijweg, omkeren verband

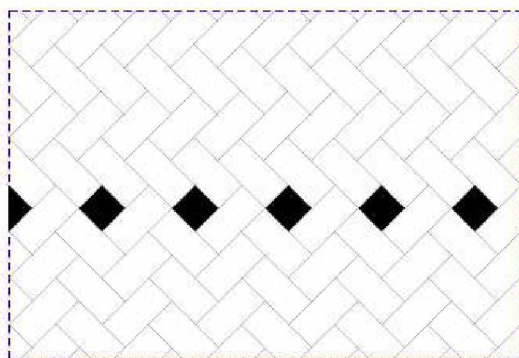

2 om 2

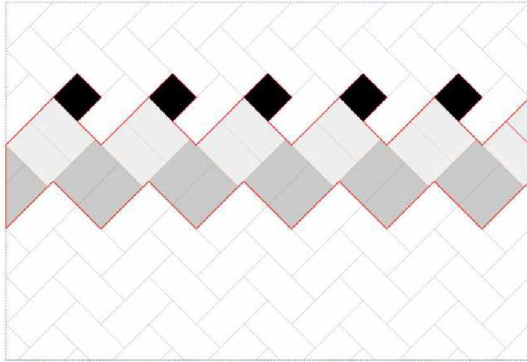

3 om 3

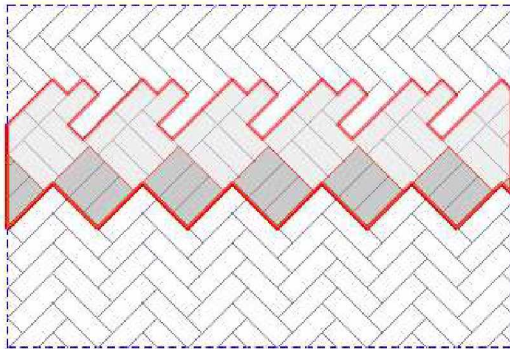

4 om 4

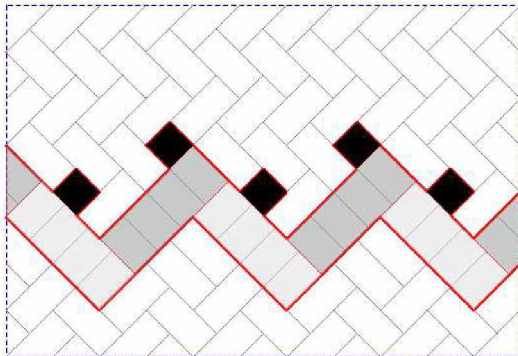

Objecten

Put door middel van een molenwiek

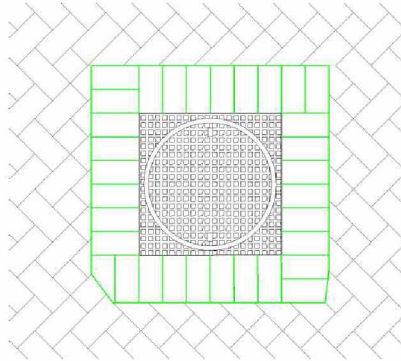

Put door middel van strekse lagen

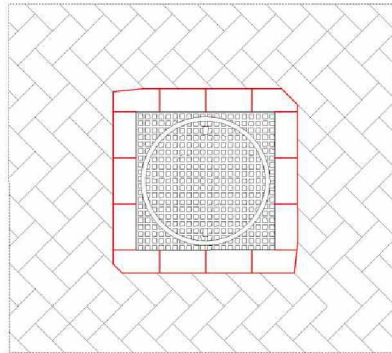

Putten in tegelverharding

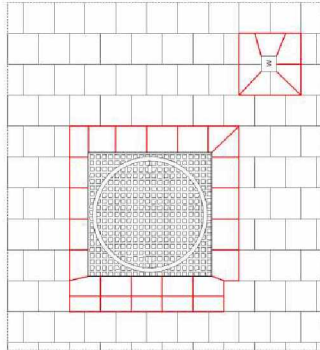

Overig

Recht zagen passtukken

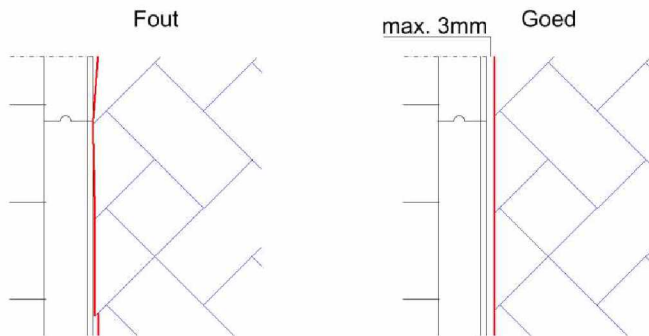

Hakwerk rond kolk in voetpad

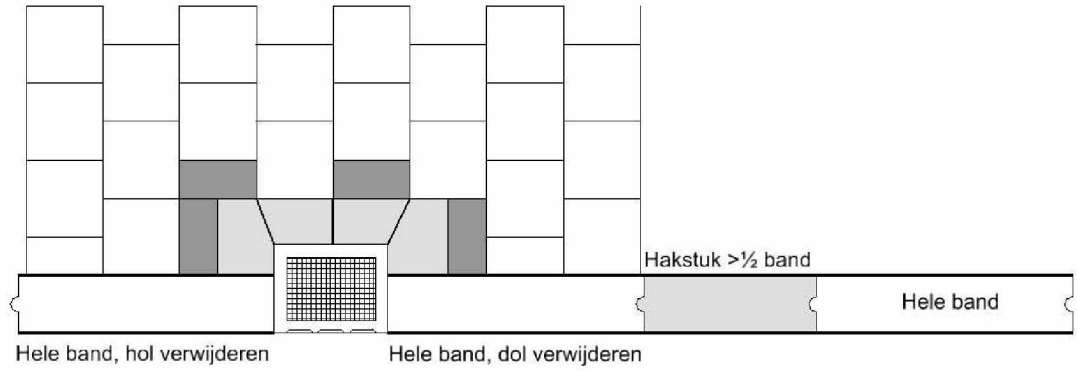

Detail hakwerk rond kolk