

CORE CONSTRUCTIES

Statische Berekening

Project: 5.1.2.e
Onderdeel: Dakopbouw
Opdrachtgever: Structure Engineering
T.a.v. 5.1.2.e
Van 5.1.2.e 18III
5.1.2.e Amsterdam
Projectnummer: 18047
Datum: 26-06-2018
Gewijzigd: Rev1 14-10-2019
Rev2 01-11-2022
Rev3 28-04-2023

Opgesteld:

5.1.2.e

5.1.2.e

Inhoudsopgave

1	Inleiding	5
1.1	<i>Algemeen</i>	5
1.2	<i>Wijzigingen</i>	5
1.3	<i>Belastingtoename</i>	5
2	Aangehouden belastingen	5
3	Materialen	5
4	Algemene rekenmethodes	6
5	Beschikbare informatie	6
5.1	<i>Algemeen</i>	6
6	Plattegrond met posnummers	7
6.1	<i>Daklaag</i>	7
6.2	<i>Uitbreiding 4^e verdiepingsvloer</i>	7
6.3	<i>4^e verdiepingsvloer</i>	8
6.4	<i>3^e verdiepingsvloer</i>	8
7	Statische berekening	9
7.1	<i>Pos 1</i>	9
7.1.1	Geometrie	9
7.1.2	Belastingen	9
7.1.3	Toegepaste maatregel	9
7.1.4	Uiterste grenstoestand	9
7.1.5	Bruikbaarheids grenstoestand	9
7.2	<i>Pos 2</i>	10
7.2.1	Geometrie	10
7.2.2	Belastingen	10
7.2.3	Toegepaste maatregel	10
7.2.4	Uiterste grenstoestand	10
7.2.5	Bruikbaarheids grenstoestand	10
7.3	<i>Pos 3</i>	11
7.3.1	Geometrie	11
7.3.2	Belastingen	11
7.3.3	Toegepaste maatregel	11
7.3.4	Uiterste grenstoestand	11
7.3.5	Bruikbaarheids grenstoestand	11
7.4	<i>Pos 4</i>	12
7.4.1	Geometrie	12
7.4.2	Belastingen	12
7.4.3	Toegepaste maatregel	12
7.4.4	Uiterste grenstoestand	13
7.4.5	Bruikbaarheids grenstoestand	13

7.5	Pos 5	14
7.5.1	Geometrie	14
7.5.2	Belastingen	14
7.5.3	Toegepaste maatregel	15
7.5.4	Uiterste grenstoestand	15
7.5.5	Bruikbaarheids grenstoestand	15
7.6	Pos 6	16
7.6.1	Geometrie	16
7.6.2	Belastingen	16
7.6.3	Toegepaste maatregel	16
7.6.4	Uiterste grenstoestand	16
7.6.5	Bruikbaarheids grenstoestand	16
7.7	Pos 7	17
7.7.1	Geometrie	17
7.7.2	Belastingen	17
7.7.3	Toegepaste maatregel	17
7.7.4	Uiterste grenstoestand	17
7.7.5	Bruikbaarheids grenstoestand	17
7.8	Pos 8	18
7.8.1	Geometrie	18
7.8.2	Belastingen	18
7.8.3	Toegepaste maatregel	18
7.8.4	Uiterste grenstoestand	18
7.8.5	Bruikbaarheids grenstoestand	18
7.9	Pos 9	19
7.9.1	Geometrie	19
7.9.2	Belastingen	19
7.9.3	Toegepaste maatregel	19
7.9.4	Uiterste grenstoestand	19
7.9.5	Bruikbaarheids grenstoestand	19
7.10	Pos 10	20
7.10.1	Geometrie	20
7.10.2	Belastingen	20
7.10.3	Toegepaste maatregel	20
7.10.4	Uiterste grenstoestand	20
7.10.5	Bruikbaarheids grenstoestand	20
7.11	Pos 11	21
7.11.1	Geometrie	21
7.11.2	Belastingen	21
7.11.3	Toegepaste maatregel	21
7.11.4	Uiterste grenstoestand	21
7.11.5	Bruikbaarheids grenstoestand	21
7.12	Pos 12	22
7.12.1	Geometrie	22
7.12.2	Belastingen	22
7.12.3	Toegepaste maatregel	22
7.12.4	Uiterste grenstoestand	22
7.12.5	Bruikbaarheids grenstoestand	22
7.13	Pos 13	23
7.13.1	Geometrie	23

7.13.2	Belastingen	23
7.13.3	Toegepaste maatregel	23
7.13.4	Uiterste grenstoestand	23
7.13.5	Bruikbaarheids grenstoestand	23
7.14	<i>Pos 14</i>	24
7.14.1	Geometrie	24
7.14.2	Belastingen	24
7.14.3	Toegepaste maatregel	25
7.14.4	Uiterste grenstoestand	25
7.14.5	Bruikbaarheids grenstoestand	25
7.15	<i>Pos 15</i>	26
7.15.1	Uitgangspunten	26
7.15.2	Geometrie	26
7.15.3	Belastingen	26
7.15.4	Toegepaste maatregel	27
7.15.5	Uiterste grenstoestand	27
7.15.6	Bruikbaarheids grenstoestand	27
7.15.7	Verbindingen	28
7.15.8	Opleggingen	29
7.15.8.1	Oplegging 1	29
7.15.8.2	Oplegging 2	29
7.16	<i>Pos 16</i>	30
7.16.1	Geometrie	30
7.16.2	Belastingen	30
7.16.3	Toegepaste maatregel	30
7.16.4	Uiterste grenstoestand	30
7.16.5	Bruikbaarheids grenstoestand	30
7.16.6	Opleggingen	31
7.17	<i>Pos 17</i>	32
7.17.1	Geometrie	32
7.17.2	Belastingen	32
7.17.3	Toegepaste maatregel	32
7.17.4	Uiterste grenstoestand	32
7.17.5	Bruikbaarheids grenstoestand	32
7.18	<i>Pos 18</i>	33
7.18.1	Uitgangspunten	33
7.18.2	Geometrie	33
7.18.3	Belastingen	33
7.18.4	Toegepaste maatregel	33
7.18.5	Uiterste grenstoestand	33
7.18.6	Bruikbaarheids grenstoestand	33
7.19	<i>Pos 19</i>	34
7.19.1	Uitgangspunten	34
7.19.2	Geometrie	34
7.19.3	Belastingen	34
7.19.4	Toegepaste maatregel	34
7.19.5	Uiterste grenstoestand	34
7.19.6	Bruikbaarheids grenstoestand	34
8	Bijlagen	35
8.1	<i>Bijlage ultraal MatrixFrame berekening Pos 1</i>	35

8.2	<i>Bijlage uitraai MatrixFrame berekening Pos 2</i>	44
8.3	<i>Bijlage uitraai MatrixFrame berekening Pos 3</i>	52
8.4	<i>Bijlage uitraai MatrixFrame berekening Pos 4</i>	60
8.5	<i>Bijlage uitraai MatrixFrame berekening Pos 5</i>	64
8.6	<i>Bijlage uitraai MatrixFrame berekening Pos 6</i>	68
8.7	<i>Bijlage uitraai MatrixFrame berekening Pos 7</i>	77
8.8	<i>Bijlage uitraai MatrixFrame berekening Pos 8</i>	85
8.9	<i>Bijlage uitraai MatrixFrame berekening Pos 9</i>	95
8.10	<i>Bijlage uitraai MatrixFrame berekening Pos 10</i>	103
8.11	<i>Bijlage uitraai MatrixFrame berekening Pos 11</i>	112
8.12	<i>Bijlage uitraai MatrixFrame berekening Pos 12</i>	120
8.13	<i>Bijlage uitraai MatrixFrame berekening Pos 13</i>	128
8.14	<i>Bijlage uitraai MatrixFrame berekening Pos 14</i>	137
8.15	<i>Bijlage uitraai MatrixFrame berekening Pos 15</i>	141
8.16	<i>Bijlage uitraai MatrixFrame berekening Pos 16</i>	156
8.17	<i>Bijlage uitraai MatrixFrame berekening Pos 17</i>	169
8.18	<i>Bijlage uitraai MatrixFrame berekening Pos 18</i>	176
8.19	<i>Bijlage uitraai MatrixFrame berekening Pos 19</i>	184

1 Inleiding

1.1 Algemeen

Het pand aan de 5.1.2.e wordt verbouwd. Er wordt een dakopbouw en een dakterras geplaatst.

In deze berekening worden de constructieve elementen hiervan beschouwd.

1.2 Wijzigingen

- Rev1 De dakopbouw bestaat uit 2 lagen
 Rev2 De dakopbouw van de 4^e verdieping is reeds vergund. De wijzigingen hebben enkel betrekking op de uitbreiding van de 4^e verdieping. De dakterrassen aan weerszijden van de uitbreiding komen te vervallen en de wanden verplaatsen 25cm vanaf de bouwmuren. Pos 8 & 15 aangepast. Pos 6, 9, 10 & 11 worden minder zwaar belast door het vervallen van het dakterras, deze zijn in de berekening echter ongewijzigd gelaten. Pos 17, 18 & 19 bijgevoegd.
 Rev3 belastingtoename vermeld onder 1.3 Belastingtoename

1.3 Belastingtoename

Het pand wordt voorzien van een funderingsherstel. Bij dit funderingsherstel is rekening gehouden met een dakopbouw met dakterras over de gehele diepte van het pand, van zowel nummer 26 als van beide buurpanden. Dit funderingsherstel is berekend in berekening Core Constructies SB-CC22056-fundering-rev1 d.d. 29-11-2022.

2 Aangehouden belastingen

permanent

plat dak	= 0,60kN/m ²
dak+dakterras	= 0,90kN/m ²
HSB	= 0,70kN/m ²
pui	= 0,70kN/m ²
Houten vloeren	= 0,70kN/m ²
badkamers	= 1,50kN/m ²
mw	= 20,0kN/m ³
beton	= 25,0kN/m ³

veranderlijk

vloeren (woning)	= 2,55kN/m ² (incl. 0,80kN/m ² lichte scheidingswanden)
Balkons/dakterras	= 2,50kN/m ²

3 Materialen

hout binnen	C24
hout buiten	C24 geïmpregneerd
staal	S235
bouten	8.8
beton	C20/25
wapening	B500A

4 Algemene rekenmethodes

Berekeningen conform Eurocodes..

Gevolgklasse CC2

5 Beschikbare informatie

5.1 Algemeen

Voor het bepalen van de statische berekening is gebruik gemaakt van de volgende informatie:

- Tekening LinQ Vastgoed Adviseurs BV 1143 d.d. 09-08-2018
- Principe tekening Structure Engineering CO-18048-rev3
- Inmetingen/foto's/locatiebezoek Structure Engineering

6 Plattegrond met posnummers

6.1 Daklaag

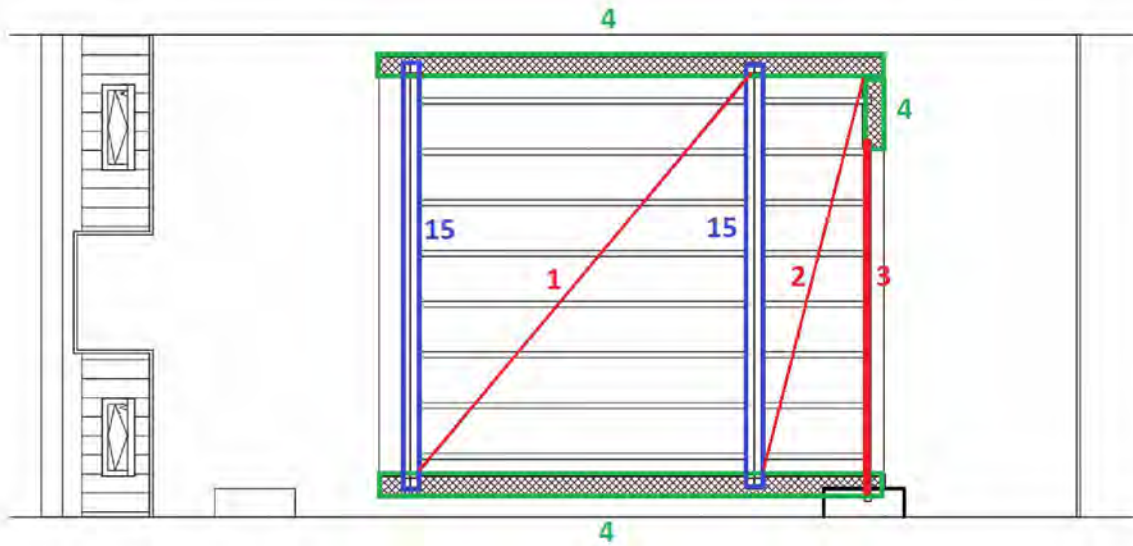

6.2 Uitbreiding 4^e verdiepingvloer

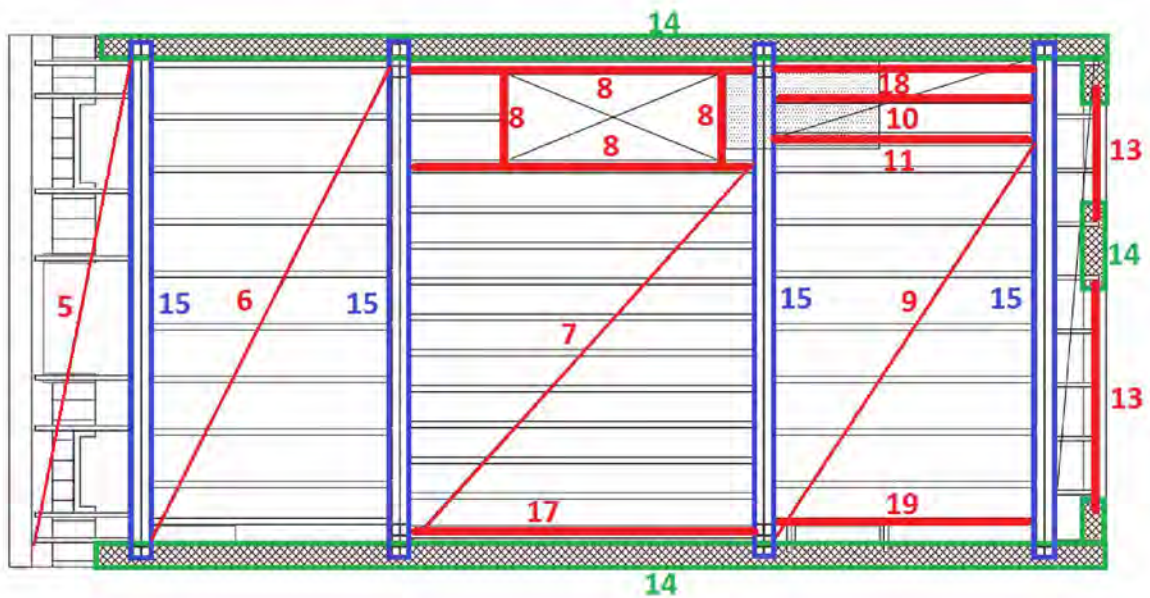

6.3 4^e verdiepingvloer

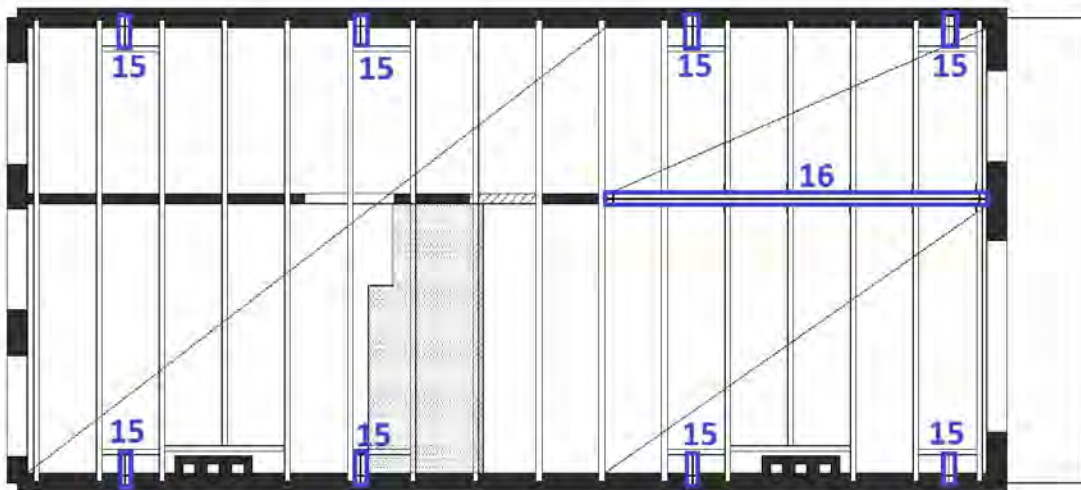

6.4 3^e verdiepingvloer

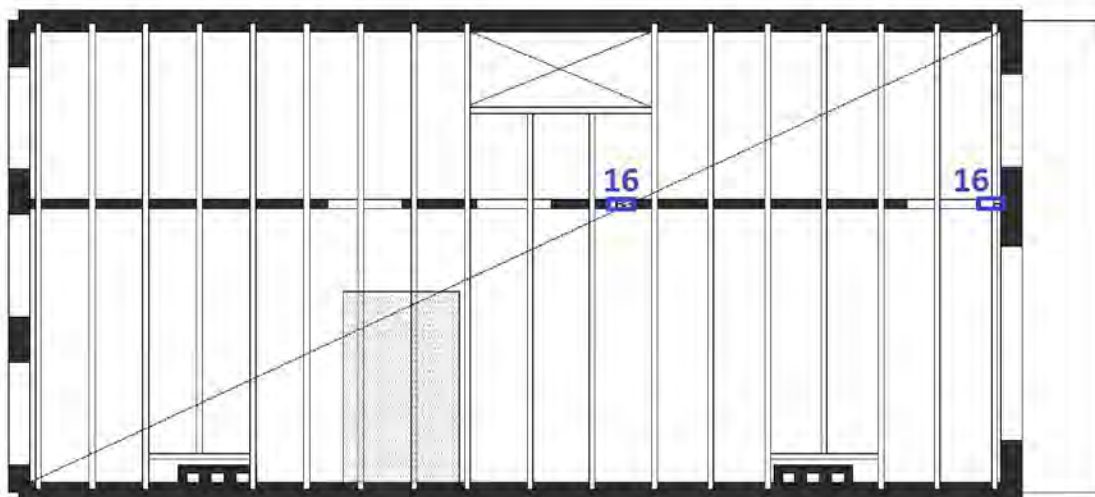

7 Statische berekening

7.1 Pos 1

7.1.1 Geometrie

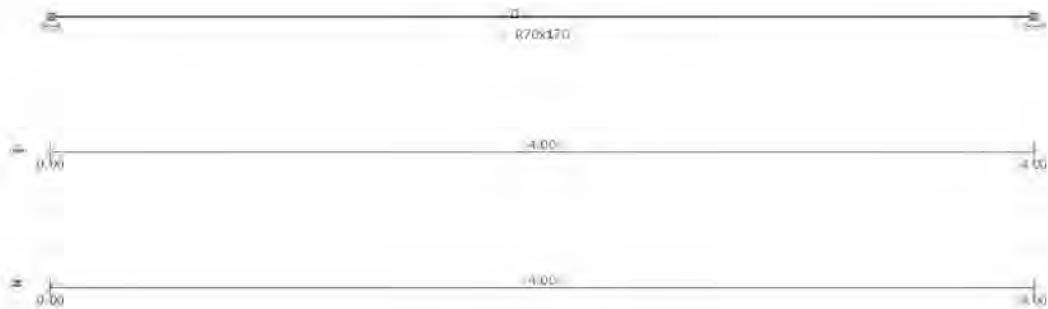

7.1.2 Belastingen

Permanent

$q_{pb,rep}$ plat dak 0,6x0,60 = 0,36kN/m

Veranderlijk

$q_{vb,rep}$ dak 0,6x1,00 = 0,60kN/m

sneeuw 0,6x0,56 = 0,34kN/m

$F_{vb,rep}$ Opgelegd = 2,00kN

7.1.3 Toegepaste maatregel

70x170mm, h.o.h. 600mm

7.1.4 Uiterste grenstoestand

UC Drsn = 0,78, zie uitvoer MatrixFrame >> AKKOORD

UC Kip/stab = 0,78, zie uitvoer MatrixFrame >> AKKOORD

7.1.5 Bruikbaarheids grenstoestand

UC δ_{max} = 0,78, zie uitvoer MatrixFrame >> AKKOORD

UC δ_3 = 0,54, zie uitvoer MatrixFrame >> AKKOORD

7.2 Pos 2

7.2.1 Geometrie

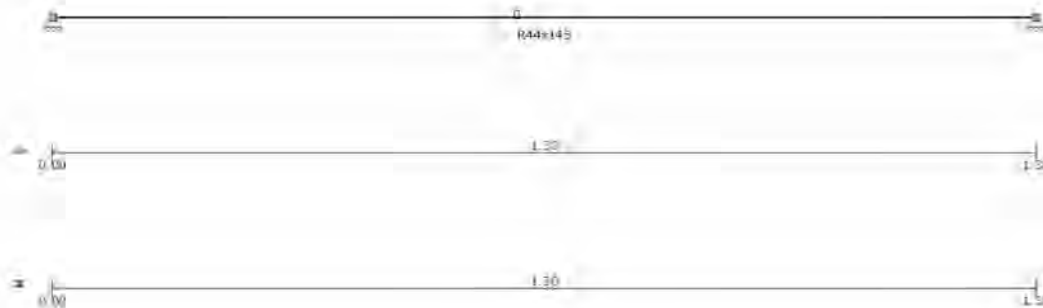

7.2.2 Belastingen

Permanent

$q_{pb,rep}$ plat dak $0,6 \times 0,60 = 0,36 \text{ kN/m}$

Veranderlijk

$q_{vb,rep}$ dak $0,6 \times 1,00 = 0,60 \text{ kN/m}$

sneeuw $0,6 \times 0,56 = 0,34 \text{ kN/m}$

$F_{vb,rep}$ Opgelegd $= 2,00 \text{ kN}$

7.2.3 Toegepaste maatregel

44x145mm, h.o.h. 600mm

7.2.4 Uiterste grenstoestand

UC Drsn = 0,47, zie uitvoer MatrixFrame >> AKKOORD

UC Kip/stab = 0,47, zie uitvoer MatrixFrame >> AKKOORD

7.2.5 Bruikbaarheids grenstoestand

UC $\delta_{max} = 0,07$, zie uitvoer MatrixFrame >> AKKOORD

UC $\delta_3 = 0,05$, zie uitvoer MatrixFrame >> AKKOORD

7.3 Pos 3

7.3.1 Geometrie

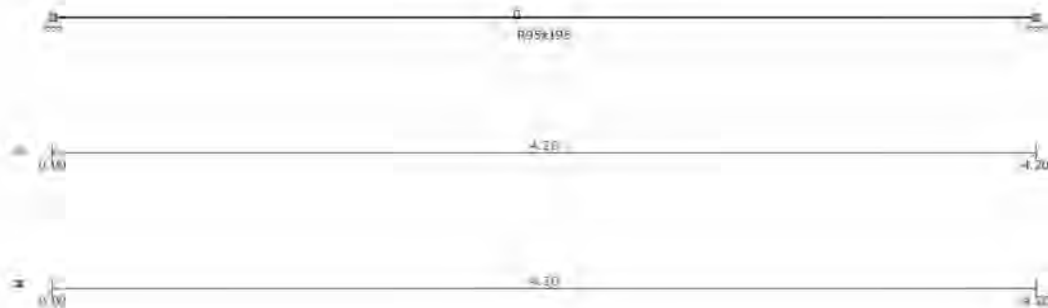

7.3.2 Belastingen

Permanent

$q_{pb,rep}$ plat dak $1/2 \times 1,5 \times 0,60 = 0,45 \text{ kN/m}$

Veranderlijk

$q_{vb,rep}$ dak $1/2 \times 1,5 \times 1,00 = 0,75 \text{ kN/m}$

sneeuw $1/2 \times 1,5 \times 0,56 = 0,42 \text{ kN/m}$

$F_{vb,rep}$ Opgelegd $= 2,00 \text{ kN}$

7.3.3 Toegepaste maatregel

95x195mm

7.3.4 Uiterste grenstoestand

UC Drsn = 0,49, zie uitvoer MatrixFrame >> AKKOORD

UC Kip/stab = 0,49, zie uitvoer MatrixFrame >> AKKOORD

7.3.5 Bruikbaarheids grenstoestand

UC δ_{max} = 0,55, zie uitvoer MatrixFrame >> AKKOORD

UC δ_3 = 0,38, zie uitvoer MatrixFrame >> AKKOORD

7.4 Pos 4

7.4.1 Geometrie



7.4.2 Belastingen

Permanent

$F_{pb,rep}$	plat dak	$0,4 \times 1/2 \times 1,5 \times 0,60$	= 0,18kN
$q_{pb,rep}$	HSB	$0,4 \times 0,70$	= 0,28kN/m

Veranderlijk

$F_{vb,rep}$	dakterras	$0,4 \times 1/2 \times 1,5 \times 1,00$	= 0,30kN
	Opgelegd		= 2,00kN (maatgevend)
$q_{vb,rep}$	wind	$0,4 \times (0,8 + 0,3) \times 0,86$	= 0,38kN/m

Windgebied	II	
Terreincategorie	bebouwd	
Hoogte bouwwerk z	17.9	m
z0	0.5	m
zmin	7	m
lv(z)	0.28	
kr	0.22	
Cr	0.80	
CO	1	
v,b,0	27	m/s
vm(z)	21.57	m/s
qp(z)	0.86	kN/m ²

7.4.3 Toegepaste maatregel

38x120mm, h.o.h. 400mm. Dubbele stijlen naast alle openingen en onder opleggingen houten balk Pos 3. Aan minimaal 1 zijde beplaten met 12mm multiplex i.v.m. stabiliteit.

7.4.4 Uiterste grenstoestand

UC Drs_n = 0,26, zie uitvoer MatrixFrame >> AKKOORD

UC Kip/stab = 0,29, zie uitvoer MatrixFrame >> AKKOORD ($I_{buc}/I_{sys} = 0,1$ in zwakke richting)

7.4.5 Bruikbaarheids grenstoestand

N.v.t.

7.5 Pos 5

7.5.1 Geometrie



7.5.2 Belastingen

Permanent

$Q_{pb,rep}$	schuin dak	$1/2 \times 0,8 \times 0,80$	= 0,32kN/m
	plat dak	$1/2 \times 1,3 \times 0,60$	= 0,39kN/m
	HSB	$2,5 \times 0,70$	= 1,75kN/m

Veranderlijk

$Q_{vb,rep}$	plat dak	$1/2 \times 1,3 \times 1,00$	= 0,65kN/m
$F_{vb,rep}$	Opgelegd		= 2,00kN (maatgevend)

wind

$q_{vb,rep}$	wind	$1/2 \times 0,8 \times (0,8 + 0,3) \times 0,86$	= 0,38kN/m
	wind	$1/2 \times 1,3 \times (0,8 + 0,3) \times 0,86$	= 0,61kN/m

Windgebied	II	
Terreincategorie	bebouwd	
Hoogte bouwwerk z	17.9	m
z_0	0.5	m
z_{min}	7	m
$lv(z)$	0.28	
kr	0.22	
Cr	0.80	
CO	1	
$v_{b,0}$	27	m/s
$vm(z)$	21.57	m/s
$qp(z)$	0.86	kN/m ²

7.5.3 Toegepaste maatregel
70x145mm, h.o.h. 1,1 gemiddeld.

7.5.4 Uiterste grenstoestand
UC Drsn = 0,50, zie uitvoer MatrixFrame >> AKKOORD
UC Kip/stab = 0,56, zie uitvoer MatrixFrame >> AKKOORD ($I_{buc}/I_{sys} = 0,1$ in zwakke richting)

7.5.5 Bruikbaarheids grenstoestand
N.v.t.

7.6 Pos 6

7.6.1 Geometrie

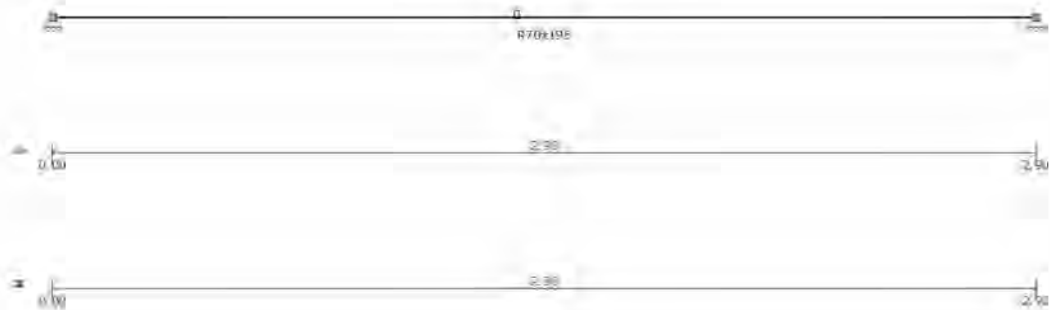

7.6.2 Belastingen

Permanent

$q_{1pb,rep}$	dak+dakterras	0,6x0,90	= 0,54kN/m
$q_{2pb,rep}$	vloer	0,6x0,70	= 0,42kN/m
$F_{pb,rep}$	pui	0,6x2,4x0,70	= 1,01kN

Veranderlijk

$q_{1vb,rep}$	dak+dakterras	0,6x2,50	= 1,50kN/m
$q_{2vb,rep}$	vloer	0,6x2,55	= 1,53kN/m
$F_{vb,rep}$	Opgelegd		= 3,00kN

7.6.3 Toegepaste maatregel

70x195mm, h.o.h. 600mm

7.6.4 Uiterste grenstoestand

UC Drsn = 0,63, zie uitvoer MatrixFrame >> AKKOORD

UC Kip/stab = 0,63, zie uitvoer MatrixFrame >> AKKOORD

7.6.5 Bruikbaarheids grenstoestand

UC δ_{max} = 0,48, zie uitvoer MatrixFrame >> AKKOORD

UC δ_3 = 0,49, zie uitvoer MatrixFrame >> AKKOORD

7.7 Pos 7

7.7.1 Geometrie

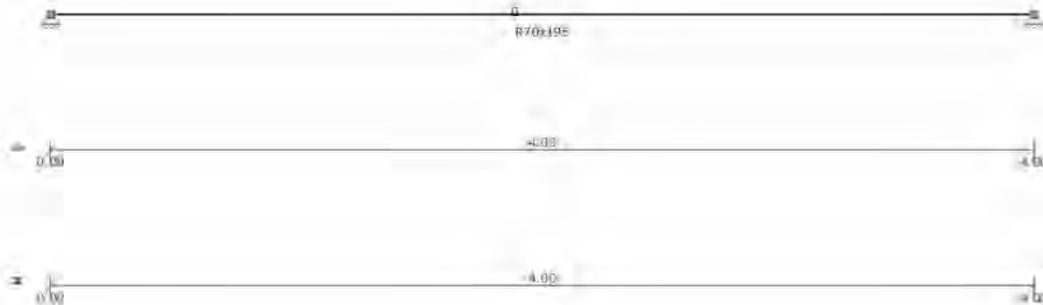

7.7.2 Belastingen

Permanent

$Q_{pb;rep}$ vloer $0,4 \times 0,70 = 0,28 \text{ kN/m}$

Veranderlijk

$Q_{vb;rep}$ vloer $0,4 \times 2,55 = 1,02 \text{ kN/m}$

$F_{vb;rep}$ Opgelegd $= 3,00 \text{ kN}$

7.7.3 Toegepaste maatregel

70x195mm, h.o.h. 400mm

7.7.4 Uiterste grenstoestand

UC Drsn = 0,79, zie uitvoer MatrixFrame >> AKKOORD

UC Kip/stab = 0,79, zie uitvoer MatrixFrame >> AKKOORD

7.7.5 Bruikbaarheids grenstoestand

UC δ_{max} = 0,72, zie uitvoer MatrixFrame >> AKKOORD

UC δ_3 = 0,80, zie uitvoer MatrixFrame >> AKKOORD

7.8 Pos 8

7.8.1 Geometrie

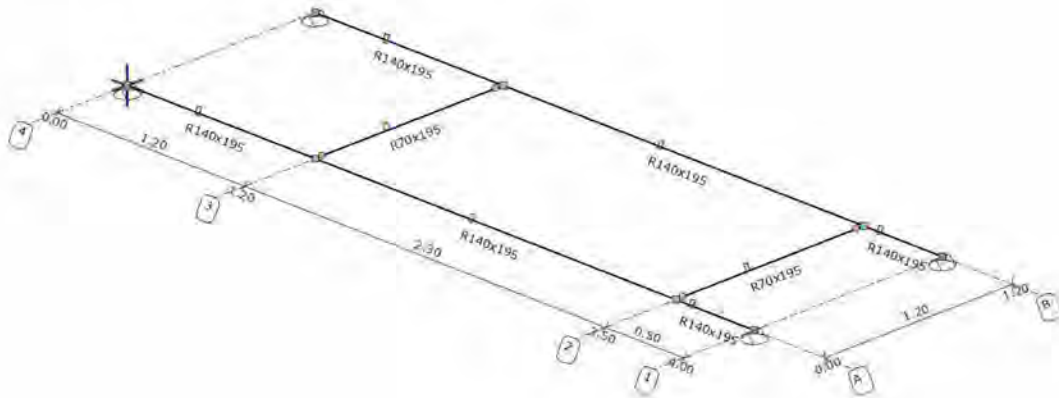

7.8.2 Belastingen

Permanent

q _{1pb;rep}	vloer	0,6x0,70	= 0,42kN/m
q _{2pb;rep}	vloer	1/2x1,2x0,70	= 0,42kN/m
q _{3pb;rep}	vloer + badk.	1/2x0,5x1,50	= 0,38kN/m
q _{4pb;rep}	vloer	1/2x0,6x0,70	= 0,21kN/m
	HSB	2,4x0,70	= 1,68kN/m
	TOTAAL		= 1,89kN/m

Veranderlijk

q _{1vb;rep}	vloer	0,6x2,55	= 1,53kN/m
q _{2vb;rep}	vloer	1/2x1,2x2,55	= 1,53kN/m
q _{3vb;rep}	vloer	1/2x0,5x2,55	= 0,64kN/m
q _{4vb;rep}	vloer	1/2x0,6x2,55	= 0,77kN/m
F _{vb;rep}	Opgelegd		= 3,00kN

7.8.3 Toegepaste maatregel

Langsravelingen dubbele 70x195mm, ravelingen 70x195mm

7.8.4 Uiterste grenstoestand

UC Drsn = 0,61, zie uitvoer MatrixFrame >> AKKOORD

UC Kip/stab = 0,61, zie uitvoer MatrixFrame >> AKKOORD

7.8.5 Bruikbaarheids grenstoestand

UC δ_{max} = 0,61, zie uitvoer MatrixFrame >> AKKOORD

UC δ_3 = 0,46, zie uitvoer MatrixFrame >> AKKOORD

7.9 Pos 9

7.9.1 Geometrie

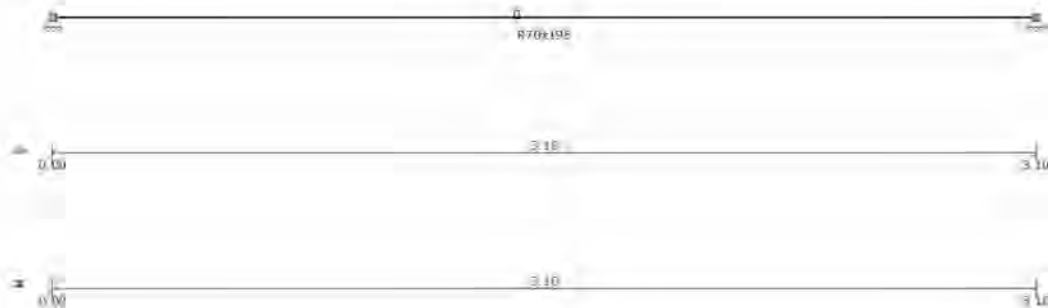

7.9.2 Belastingen

Permanent

$q_{1pb,rep}$	dak+dakterras	0,6x0,90	= 0,54kN/m
$q_{2pb,rep}$	vloer	0,6x0,70	= 0,42kN/m
$F_{pb,rep}$	pui	0,6x2,4x0,70	= 1,01kN

Veranderlijk

$q_{1vb,rep}$	dak+dakterras	0,6x2,50	= 1,50kN/m
$q_{2vb,rep}$	vloer	0,6x2,55	= 1,53kN/m
$F_{vb,rep}$	Opgelegd		= 3,00kN

7.9.3 Toegepaste maatregel

70x195mm, h.o.h. 600mm

7.9.4 Uiterste grenstoestand

UC Drsn = 0,77, zie uitvoer MatrixFrame >> AKKOORD

UC Kip/stab = 0,77, zie uitvoer MatrixFrame >> AKKOORD

7.9.5 Bruikbaarheids grenstoestand

UC δ_{max} = 0,69, zie uitvoer MatrixFrame >> AKKOORD

UC δ_3 = 0,65, zie uitvoer MatrixFrame >> AKKOORD

7.10 Pos 10

7.10.1 Geometrie

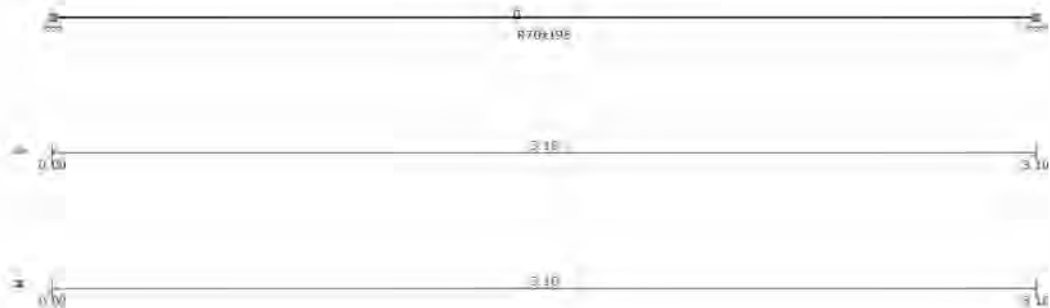

7.10.2 Belastingen

Permanent

$q_{1pb;rep}$	dak+dakterras	0,4x0,90	= 0,36kN/m
$q_{2pb;rep}$	badkamer	0,4x1,50	= 0,60kN/m
$F_{pb;rep}$	HSB	0,4x2,4x0,70	= 0,67kN
	Plat dak	0,4x1/2x1,5x0,60	= 0,18kN
	TOTAAL		= 0,85kN

Veranderlijk

$q_{1vb;rep}$	dak+dakterras	0,4x2,50	= 1,00kN/m
$q_{2vb;rep}$	vloer	0,4x2,55	= 1,02kN/m
$F_{vb;rep}$	Opgelegd		= 3,00kN

7.10.3 Toegepaste maatregel

70x195mm, h.o.h. 400mm

7.10.4 Uiterste grenstoestand

UC Drsn = 0,74, zie uitvoer MatrixFrame >> AKKOORD

UC Kip/stab = 0,74, zie uitvoer MatrixFrame >> AKKOORD

7.10.5 Bruikbaarheids grenstoestand

UC δ_{max} = 0,53, zie uitvoer MatrixFrame >> AKKOORD

UC δ_3 = 0,70, zie uitvoer MatrixFrame >> AKKOORD (scheurgevoelig)

7.11 Pos 11

7.11.1 Geometrie

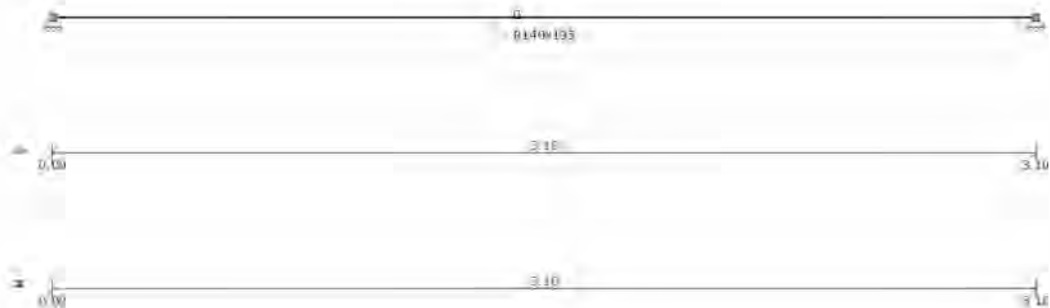

7.11.2 Belastingen

Permanent

q _{1pb;rep}	dak+dakterras	0,5x0,90	= 0,45kN/m
q _{2pb;rep}	badkamer	0,5x1,50	= 0,75kN/m
F _{pb;rep}	uit Pos 3		= 0,95kN
	HSB	0,2x2,4x0,70	= 0,34kN
	Plat dak	0,2x1/2x1,5x0,60	= 0,09kN
	TOTAAL		= 1,38kN

Veranderlijk

q _{1vb;rep}	dak+dakterras	0,5x2,50	= 1,25kN/m
q _{2vb;rep}	vloer	0,5x2,55	= 1,28kN/m
F _{vb;rep}	Opgelegd		= 3,00kN

7.11.3 Toegepaste maatregel

Dubbele 70x195mm (h.o.h. 400mm/600mm = h.o.h. 500mm gemiddeld)

7.11.4 Uiterste grenstoestand

UC Drs_n = 0,42, zie uitvoer MatrixFrame >> AKKOORD

UC Kip/stab = 0,42, zie uitvoer MatrixFrame >> AKKOORD

7.11.5 Bruikbaarheids grenstoestand

UC δ_{max} = 0,36, zie uitvoer MatrixFrame >> AKKOORD

UC δ₃ = 0,46, zie uitvoer MatrixFrame >> AKKOORD (scheurgevoelig)

7.12 Pos 12

7.12.1 Geometrie

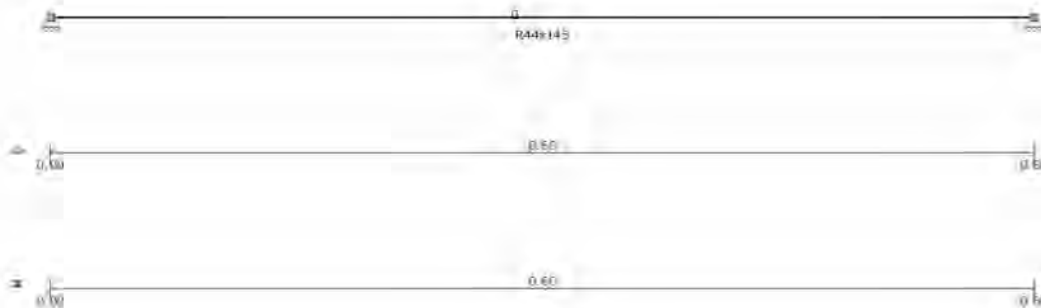

7.12.2 Belastingen

Permanent

$q_{1pb,rep}$ plat dak $0,6 \times 0,60 = 0,36 \text{ kN/m}$

Veranderlijk

$q_{1vb,rep}$ dak $0,6 \times 1,00 = 0,60 \text{ kN/m}$

sneeuw $0,6 \times 0,56 = 0,34 \text{ kN/m}$

$F_{vb,rep}$ Opgelegd $= 2,00 \text{ kN}$

7.12.3 Toegepaste maatregel

44x145mm, h.o.h. 600mm

7.12.4 Uiterste grenstoestand

UC Drsn = 0,20, zie uitvoer MatrixFrame >> AKKOORD

UC Kip/stab = 0,20, zie uitvoer MatrixFrame >> AKKOORD

7.12.5 Bruikbaarheids grenstoestand

UC δ_{max} = 0,01, zie uitvoer MatrixFrame >> AKKOORD

UC δ_3 = 0,00, zie uitvoer MatrixFrame >> AKKOORD

7.13 Pos 13

7.13.1 Geometrie

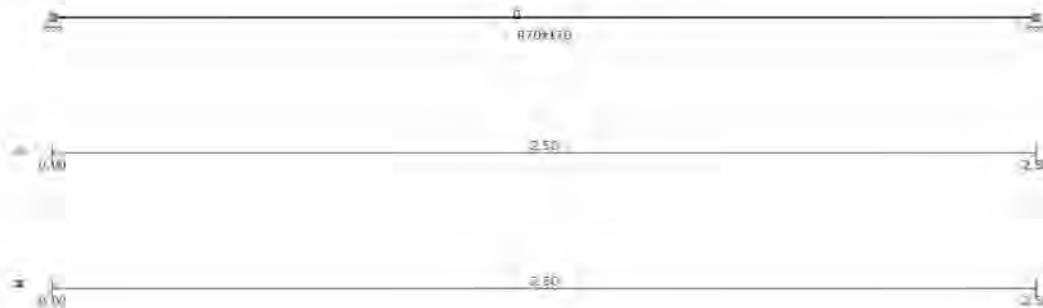

7.13.2 Belastingen

Permanent

$q_{1pb,rep}$ plat dak $1/2 \times 0,8 \times 0,60 = 0,24 \text{ kN/m}$

Veranderlijk

$q_{1vb,rep}$ dak $1/2 \times 0,8 \times 1,00 = 0,40 \text{ kN/m}$

sneeuw $1/2 \times 0,8 \times 0,56 = 0,22 \text{ kN/m}$

$F_{vb,rep}$ Opgelegd $= 2,00 \text{ kN}$

7.13.3 Toegepaste maatregel

70x170mm

7.13.4 Uiterste grenstoestand

UC Drsn = 0,42, zie uitvoer MatrixFrame >> AKKOORD

UC Kip/stab = 0,42, zie uitvoer MatrixFrame >> AKKOORD

7.13.5 Bruikbaarheids grenstoestand

UC δ_{max} = 0,13, zie uitvoer MatrixFrame >> AKKOORD

UC δ_3 = 0,09, zie uitvoer MatrixFrame >> AKKOORD

7.14 Pos 14

7.14.1 Geometrie



7.14.2 Belastingen

Permanent

$F_{pb;rep}$	plat dak	$0,4 \times 1/2 \times 0,6 \times 0,60$	= 0,07kN
	vloer	$0,4 \times 1/2 \times 0,6 \times 0,70$	= 0,08kN
	HSB	$0,4 \times 2,4 \times 0,70$	= 0,67kN
	TOTAAL		= 0,82kN

$q_{pb;rep}$	HSB	$0,4 \times 0,70$	= 0,28kN/m
--------------	-----	-------------------	------------

Veranderlijk

$F_{vb;rep}$	vloer	$0,4 \times 1/2 \times 0,6 \times 2,55$	= 0,31kN
	Opgelegd		= 3,00kN (maatgevend)
$q_{vb;rep}$	wind	$0,4 \times (0,8 + 0,3) \times 0,86$	= 0,38kN/m

Windgebied	II	
Terreincategorie	bebouwd	
Hoogte bouwwerk z	17.9	m
z0	0.5	m
zmin	7	m
lv(z)	0.28	
kr	0.22	
Cr	0.80	
CO	1	
v,b,0	27	m/s
vm(z)	21.57	m/s
qp(z)	0.86	kN/m ²

7.14.3 Toegepaste maatregel

38x120mm, h.o.h. 400mm. Dubbele stijlen naast alle openingen. Aan minimaal 1 zijde beplaten met 12mm multiplex i.v.m. stabiliteit.

7.14.4 Uiterste grenstoestand

UC Drsn = 0,28, zie uitvoer MatrixFrame >> AKKOORD

UC Kip/stab = 0,33, zie uitvoer MatrixFrame >> AKKOORD ($I_{buc}/I_{sys} = 0,1$ in zwakke richting)

7.14.5 Bruikbaarheids grenstoestand

N.v.t.

7.15 Pos 15

7.15.1 Uitgangspunten

De 4 portalen vangen 100% van de windbelasting op. De 2 maatgevende portalen worden beschouwd.

7.15.2 Geometrie

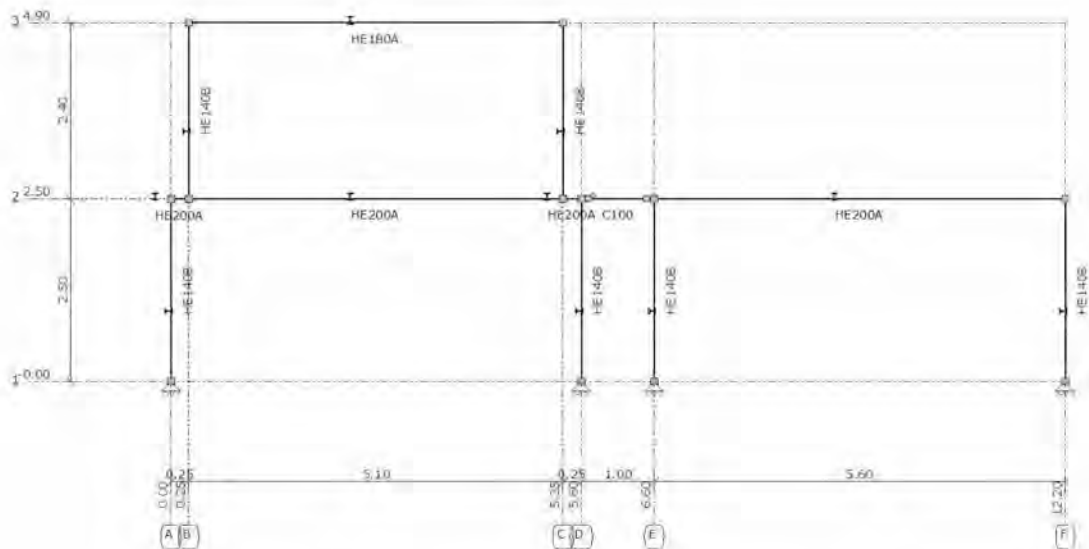

PORTAAL 1

PORTAAL 2

LET OP: Beide portalen 2x uitvoeren. De staaf C100 is enkel een rekentechnische koppelstaaf.

7.15.3 Belastingen

Permanent

PORTAAL 1

$q_{1pb;rep}$	dak	$1/2 \times 5,6 \times 0,60$	= 1,7kN/m
$q_{2pb;rep}$	vloer/dakterras	$1/2 \times 7,2 \times 1,00$	= 3,6kN/m (er wordt met 1,0kN/m ² gerekend)
	HSB/pui	$2,7 \times 0,70$	= 1,9kN/m
	TOTAAL		= 5,5kN/m

PORTAAL 2

$q_{1pb;rep}$	vloer/dakterras	$1/2 \times 3,7 \times 1,00$	= 1,9kN/m (er wordt met 1,0kN/m ² gerekend)
	HSB/pui	$50\% \times 2,7 \times 0,70$	= 1,4kN/m
	TOTAAL		= 3,3kN/m

Veranderlijk

PORTAAL 1

$q_{1vb;rep}$	dak	$1/2 \times 5,6 \times 1,00$	= 2,8kN/m
$q_{2vb;rep}$	dakterras/vloer	$1/2 \times 7,2 \times 2,55$	= 9,2kN/m

PORTAAL 2

$q_{1vb;rep}$	dakterras	$1/2 \times 3,7 \times 2,50$	= 4,6kN/m
---------------	-----------	------------------------------	-----------

Wind

PORTAAL 1

A1	$50\% \times 6,0 \times 1/2 \times 2,4 = 3,6\text{m}^2$
A2	$50\% \times 6,0 \times 1/2 \times 2,4 = 3,6\text{m}^2$
	$25\% \times 12,0 \times 1/2 \times 2,5 = 3,8\text{m}^2$
TOTAAL	$= 7,4\text{m}^2$

$F_{1,vb,rep}$	$3,6 \times 0,85 \times (0,8 + 0,7) \times 0,86 = 3,9\text{kN}$
$F_{2,vb,rep}$	$7,4 \times 0,85 \times (0,8 + 0,7) \times 0,86 = 8,1\text{kN}$

PORTAAL 2

A2	$25\% \times 12,0 \times 1/2 \times 2,5 = 3,8\text{m}^2$
----	--

PORTAAL

$F_{1,vb,rep}$	$3,8 \times 0,85 \times (0,8 + 0,7) \times 0,86 = 4,2\text{kN}$
----------------	---

Windgebied	II	
Terreincategorie	bebouwd	
Hoogte bouwwerk z	17.9	m
z0	0.5	m
zmin	7	m
lv(z)	0.28	
kr	0.22	
Cr	0.80	
C0	1	
v,b,0	27	m/s
vm(z)	21.57	m/s
qp(z)	0.86	kN/m ²

7.15.4 Toegepaste maatregel

Zie geometrie. LET OP: Beide portalen 2x uitvoeren! Alle verbindingen momentvast.

7.15.5 Uiterste grenstoestand

UC Drsn = 0,46, zie uitvoer MatrixFrame >> AKKOORD

UC Kip/stab = 0,67, zie uitvoer MatrixFrame >> AKKOORD

7.15.6 Bruikbaarheids grenstoestand

UC $\delta_{max} = 1,18$, zie uitvoer MatrixFrame >> NAGENOEG AKKOORD (horizontale verplaatsing)

UC $\delta_{max} = 0,33$, zie uitvoer MatrixFrame >> AKKOORD (doorbuiging)

UC $\delta_3 = 0,18$, zie uitvoer MatrixFrame >> AKKOORD (doorbuiging)

7.15.7 Verbindingen

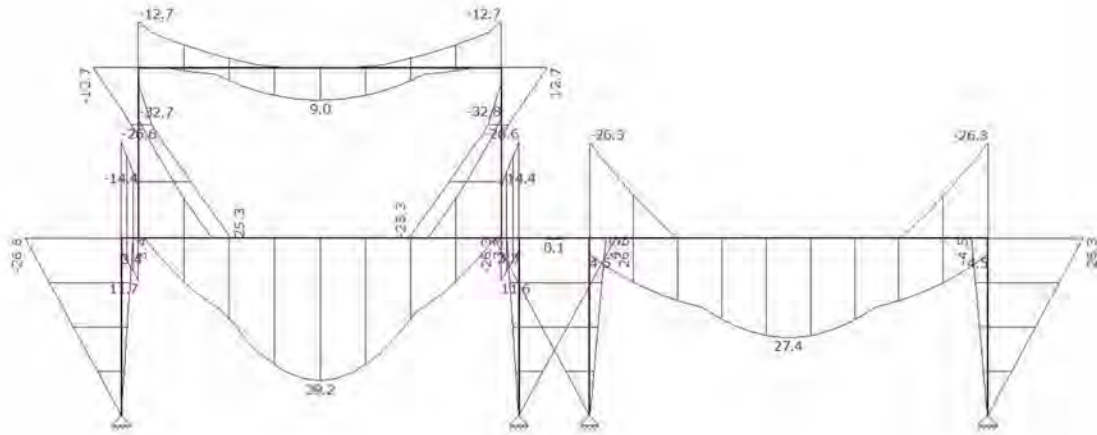

HEA180 – HEB140

Rondom lassen. Aan buitenzijde lasplaat, d=12mm toepassen. Verticale schetsplaat boven flens kolom, d=12mm toepassen.

Controle maatgevende las

$$\sigma_d \quad (12,7/0,14) \times 10^3 / (2 \times 140 \times 1 / 2 \times 9,5) \quad = 68,2 \text{ N/mm}^2$$

HEA200 – HEB140

Rondom lassen. Aan buitenzijde lasplaat, d=12mm toepassen. Verticale schetsplaat boven flens kolom, d=12mm toepassen.

Controle maatgevende las

$$\sigma_d \quad (26,6/0,14) \times 10^3 / (2 \times 140 \times 1 / 2 \times 10) \quad = 135,7 \text{ N/mm}^2$$

7.15.8 Opleggingen

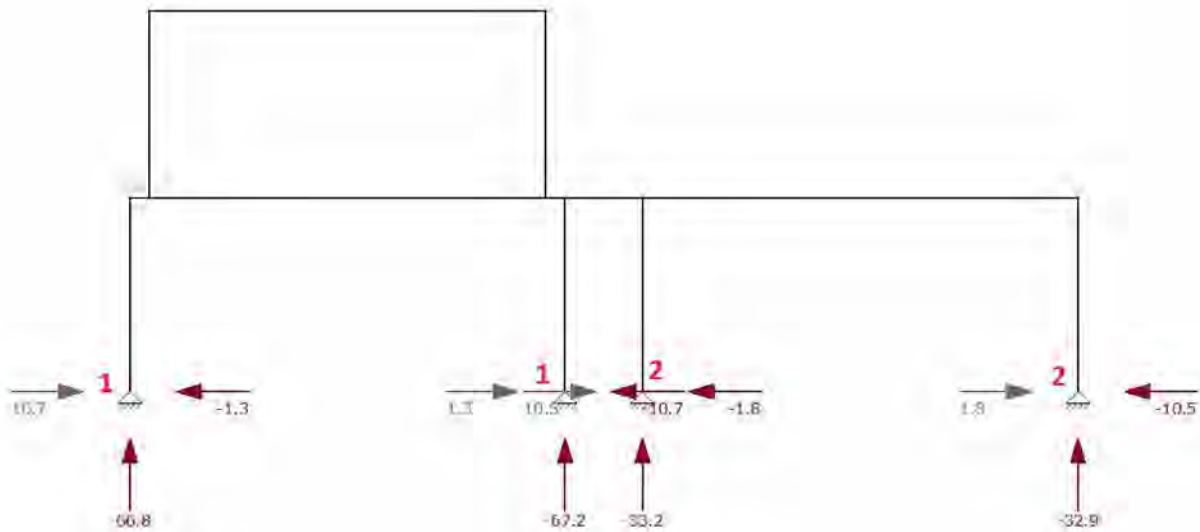

7.15.8.1 Oplegging 1

HEB140 opleggen op slof HEB140. Slof aan bestaande balklaag verbinden d.m.v. klossen. Slof opleggen op oplegplaat 250.140.10 op mw

Controle oplegdruk
 $\sigma_d = 67,2 \times 10^3 / (250 \times 140) = 1,942 / \text{mm}^2$

7.15.8.2 Oplegging 2

HEB140 opleggen op slof HEB140. Slof aan bestaande balklaag verbinden d.m.v. klossen. Slof minimaal 140mm opleggen op mw.

Controle oplegdruk
 $\sigma_d = 33,2 \times 10^3 / (140 \times 140) = 1,69 \text{ N} / \text{mm}^2$

7.16 Pos 16

7.16.1 Geometrie

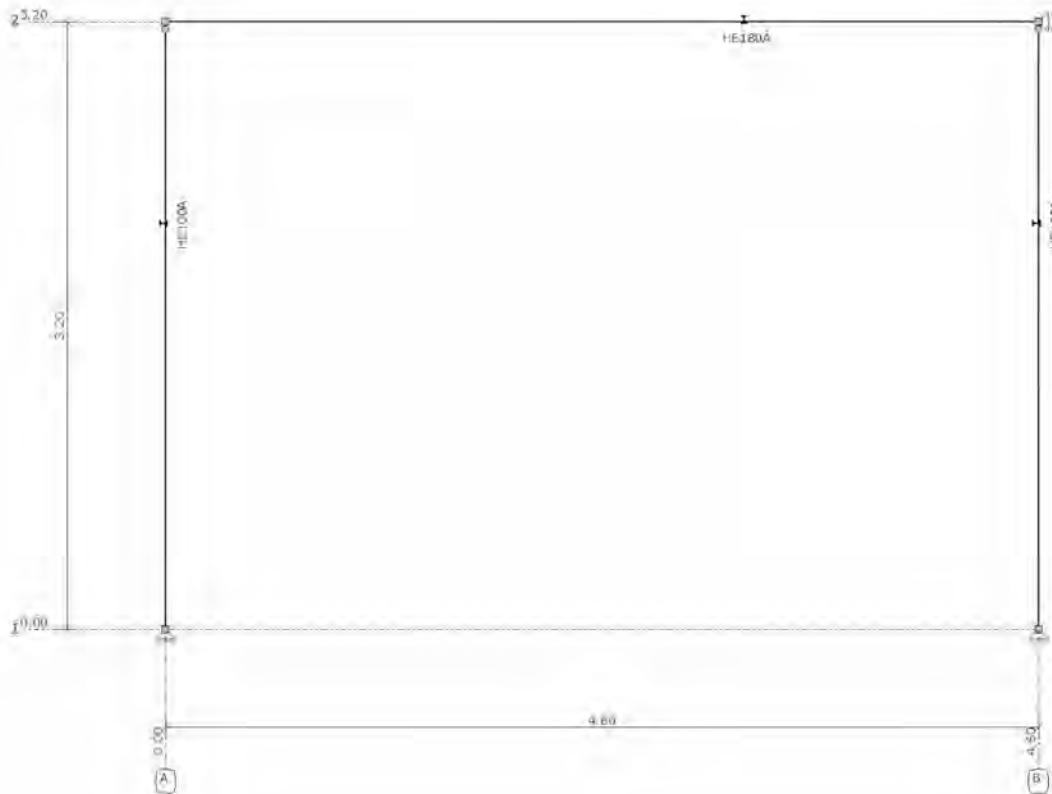

7.16.2 Belastingen

Permanent

$$q_{pb;rep} \text{ vloer} = 1/2 \times 5,5 \times 1,00 = 2,75 \text{ kN/m}$$

Veranderlijk

$$q_{vb;rep} \text{ vloer} = 1/2 \times 5,5 \times 2,55 = 7,01 \text{ kN/m}$$

7.16.3 Toegepaste maatregel

Zie geometrie

7.16.4 Uiterste grenstoestand

UC Drs_n = 0,49, zie uitvoer MatrixFrame >> AKKOORD

UC Kip/stab = 0,59, zie uitvoer MatrixFrame >> AKKOORD

7.16.5 Bruikbaarheids grenstoestand

UC δ_{max} = 0,31, zie uitvoer MatrixFrame >> AKKOORD

UC δ_3 = 0,28, zie uitvoer MatrixFrame >> AKKOORD

7.16.6 Opleggingen

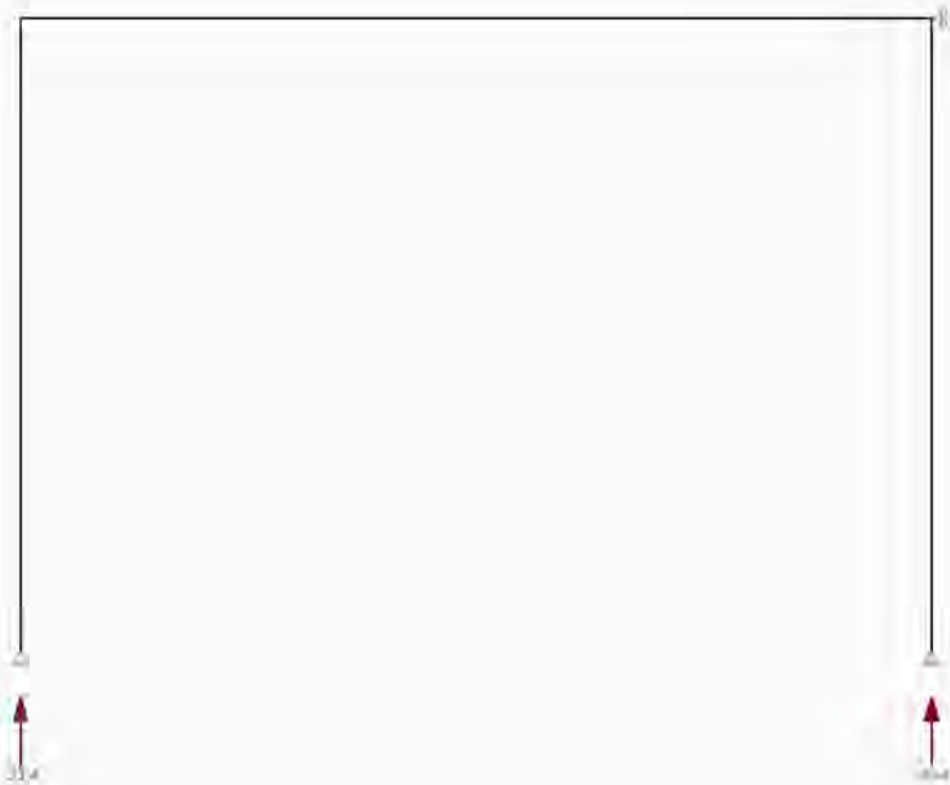

Kolommen opleggen op slof 100.200.15mm

Controle mw

$$\sigma_d = 33,4 \times 10^3 / (100 \times 200) = 1,67 \text{ N/mm}^2$$

Controle slof

$$\sigma_d = (1/2 \times 100 \times 1,67 \times 100^2) / (1/6 \times 100 \times 15^2) = 222,7 \text{ N/mm}^2$$

7.17 Pos 17

7.17.1 Geometrie

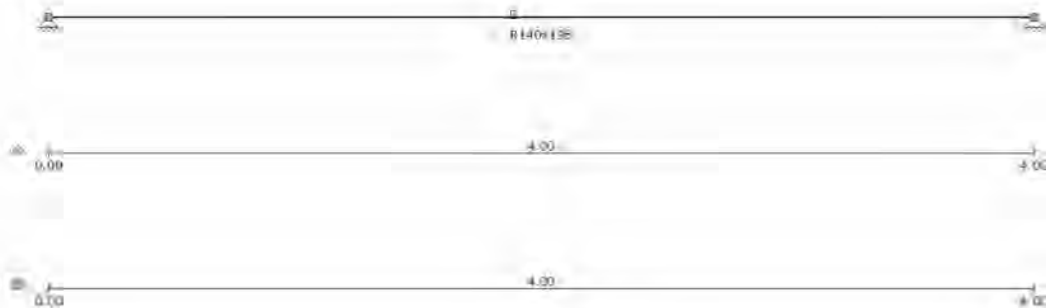

7.17.2 Belastingen

Permanent

$q_{1pb,rep}$	vloer	1/2x0,6x0,70	= 0,21kN/m
	HSB	2,4x0,70	= 1,68kN/m
	TOTAAL		= 1,89kN/m

Veranderlijk

$q_{1vb,rep}$	vloer	1/2x0,6x2,55	= 0,77kN/m
$F_{vb,rep}$	Opgelegd		= 3,00kN

7.17.3 Toegepaste maatregel

Dubbele 70x195mm

7.17.4 Uiterste grenstoestand

UC Drsn = 0,69, zie uitvoer MatrixFrame >> AKKOORD

UC Kip/stab = 0,69, zie uitvoer MatrixFrame >> AKKOORD

7.17.5 Bruikbaarheids grenstoestand

UC δ_{max} = 0,86, zie uitvoer MatrixFrame >> AKKOORD

UC δ_3 = 0,60, zie uitvoer MatrixFrame >> AKKOORD

7.18 Pos 18

7.18.1 Uitgangspunten

Er wordt tevens rekening gehouden met een mogelijk dakterras

7.18.2 Geometrie

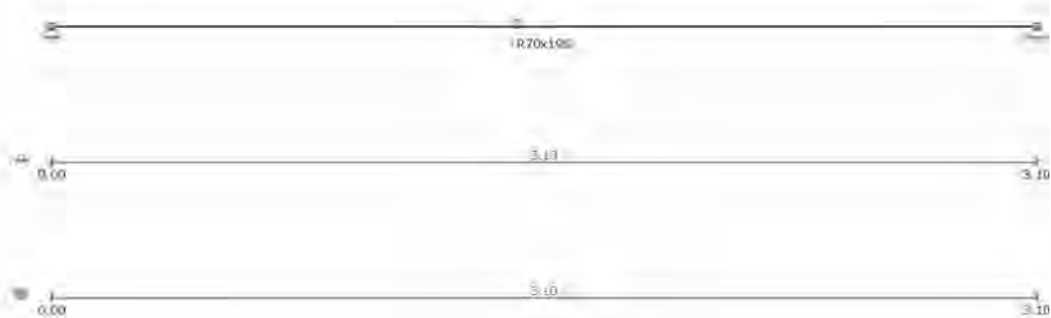

7.18.3 Belastingen

Permanent

q _{1pb;rep}	dak+dakterras	1/2x0,5x0,90	= 0,23kN/m
q _{2pb;rep}	badkamer	1/2x0,5x1,50	= 0,38kN/m
	HSB	2,4x0,70	= 1,68kN/m
	TOTAAL		= 2,06kN/m

Veranderlijk

q _{1vb;rep}	dak+dakterras	1/2x0,5x2,50	= 0,63kN/m
q _{2vb;rep}	vloer	1/2x0,5x2,55	= 0,64kN/m
F _{vb;rep}	Opgelegd		= 3,00kN

7.18.4 Toegepaste maatregel

70x195mm, h.o.h. 1/2x500mm gemiddeld

7.18.5 Uiterste grenstoestand

UC Drsn = 0,75, zie uitvoer MatrixFrame >> AKKOORD

UC Kip/stab = 0,75, zie uitvoer MatrixFrame >> AKKOORD

7.18.6 Bruikbaarheids grenstoestand

UC δ_{max} = 0,48, zie uitvoer MatrixFrame >> AKKOORD

UC δ_3 = 0,55, zie uitvoer MatrixFrame >> AKKOORD (scheurgevoelig)

7.19 Pos 19

7.19.1 Uitgangspunten

Er wordt tevens rekening gehouden met een mogelijk dakterras

7.19.2 Geometrie

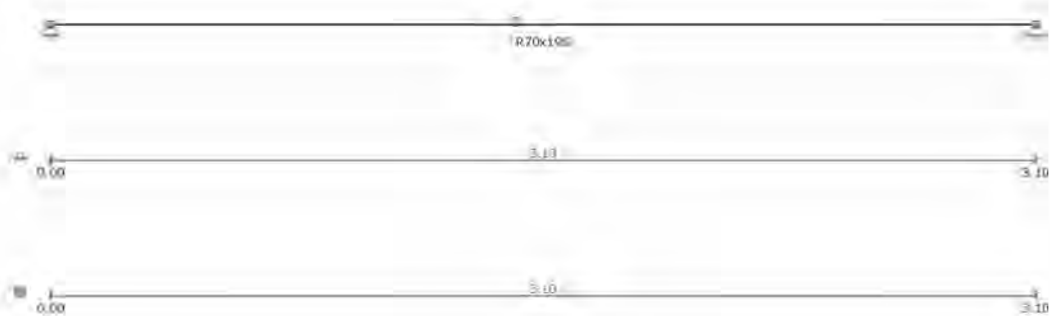

7.19.3 Belastingen

Permanent

$q_{1pb;rep}$	dak+dakterras	1/2x0,7x0,90	= 0,32kN/m
$q_{2pb;rep}$	vloer	1/2x0,7x0,70	= 0,25kN/m
	HSB	2,4x0,70	= 1,68kN/m
	TOTAAL		= 1,93kN/m
$F_{pb;rep}$	uit Pos 3		= 0,95kN
	HSB	0,2x2,4x0,70	= 0,34kN
	Plat dak	0,2x1/2x1,5x0,60	= 0,09kN
	TOTAAL		= 1,38kN

Veranderlijk

$q_{1vb;rep}$	dak+dakterras	1/2x0,7x2,50	= 0,88kN/m
$q_{2vb;rep}$	vloer	1/2x0,7x2,55	= 0,89kN/m
$F_{vb;rep}$	Opgelegd		= 3,00kN

7.19.4 Toegepaste maatregel

70x195mm, h.o.h. 1/2x700mm gemiddeld

7.19.5 Uiterste grenstoestand

UC Drs_n = 0,92, zie uitvoer MatrixFrame >> AKKOORD

UC Kip/stab = 0,92, zie uitvoer MatrixFrame >> AKKOORD

7.19.6 Bruikbaarheids grenstoestand

UC δ_{max} = 0,77, zie uitvoer MatrixFrame >> AKKOORD

UC δ_3 = 0,56, zie uitvoer MatrixFrame >> AKKOORD

8 Bijlagen

8.1 Bijlage uitraai MatrixFrame berekening Pos 1

AFB. GEOMETRIE LIGGER

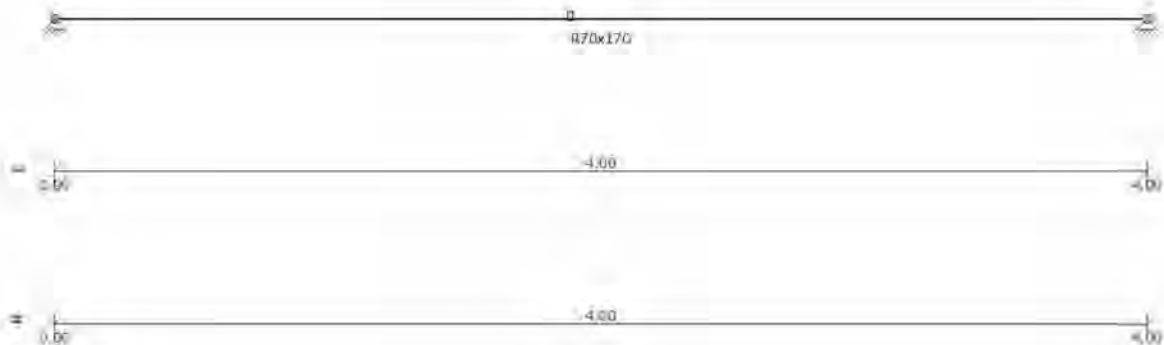

BALKGEOMETRIE

Positie	Profielnaam	5.1.2.e	Traagheidsmoment	Materiaal	E-Modulus	Uitzettingcoeff
0.000 - L(4.000)	R70x170	0	2.8659e-05	C24	1.1000e+07	50.0000e-07
0.05						
	m -			m4 -	kN/m2	C°m
	kN/m					

PROFIELVORMEN

Profiel	Verl. h.	hB	hE	tf	tw	tf2	B	bL	bR	Raatl.
P1	Nee	0,170	0,170	0,0000	0,0000	0,0000	0,070	0,000	0,000	Nee 0,000
-	-	m	m	m	m	m	m	m	m	m - m

MATERIALEN

Materiaalnaam	Poison	Dichtheid	E-Modulus	Uitzettingcoeff
C24	0.40	4.20	1.1000e+07	50.0000e-07
-	-	kN/m3	kN/m2	C°m

OPLEGGINGEN

Oplegging	Positie	Z	Yr
O1	0.000	vast	vrij
O2	L(4.000)	vast	vrij
-	m	kN/m	kNm/rad

BELASTINGSGEVALLEN TYPEN

Oplegg.	Staven	5.1.2.e	Gunstig/Ong.	Element	5.1.2.e	Psi0	Psi1	Cprob
Psi2	UGT/GGT							
B.G.1	Permanent	Permanent	-		N.v.t.	N.v.t.		
B.G.2	Verdeelde veranderlijke belasting	Verdeelde	-	Cat. H) Ontoegankelijke daken	1	1		
B.G.3	Geconcentreerde veranderlijke belasting	Geconcentreerde	-	Cat. H) Ontoegankelijke daken	N.v.t.	N.v.t.		

B.G.4 1.00/1.00	Sneeuwbelasting	belasting Sneeuwbelasting	-		N.v.t.	N.v.t.	0.20
B.G.2.1 1.00/1.00	Verdeelde veranderlijke belasting	Verdeelde veranderlijke belasting	-	Cat. H) Ontoegankelijke daken	1	1	

AFB. LASTEN B.G.1 PERMANENT

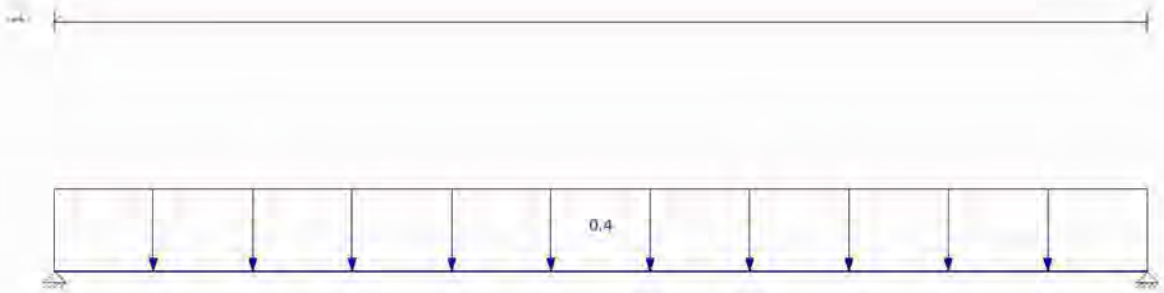

AFB. LASTEN B.G.2 VERDEELDE VERANDERLIJKE BELASTING

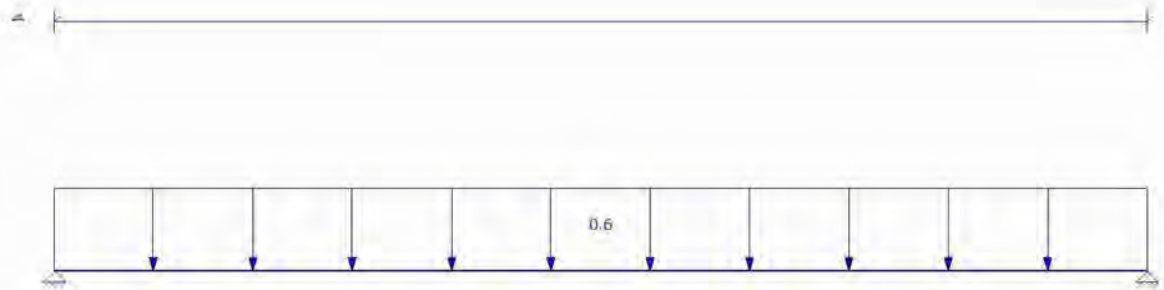

AFB. LASTEN B.G.3 GECONCENTREERDE VERANDERLIJKE BELASTING

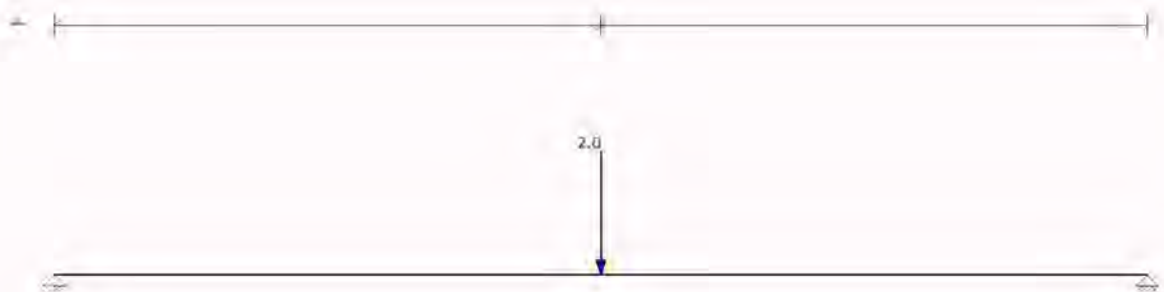

AFB. LASTEN B.G.4 SNEEUWBELASTING

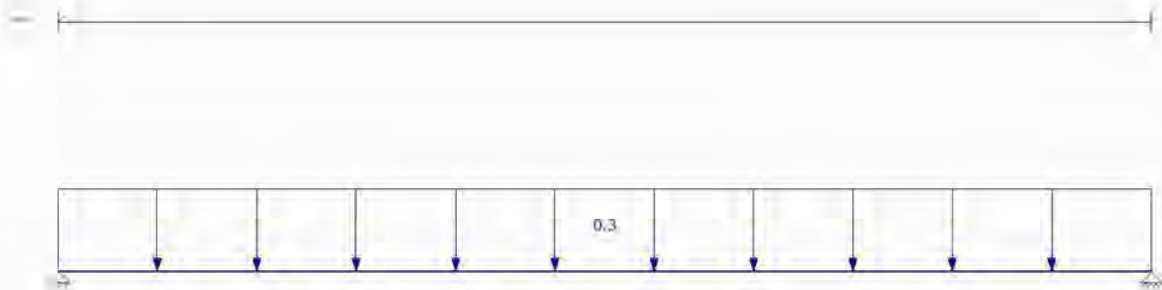

AFB. LASTEN B.G.2.1 VERDEELDE VERANDERLIJKE BELASTING

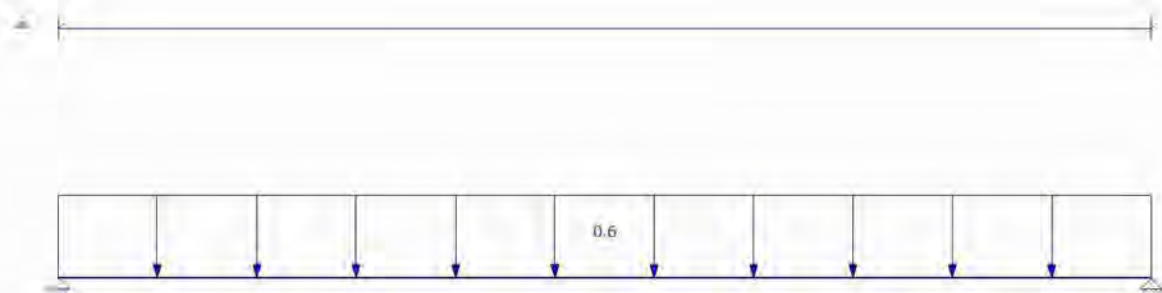

FUNDAMENTEEL BELASTINGSCOMBINATIES (TABEL)

B.G.	Omschrijving	Fu.C.1	Fu.C.2	Fu.C.3	Fu.C.4
B.G.1	Permanent	1.20	1.20	1.20	1.35
B.G.2	Verdeelde veranderlijke belasting	-	-	-	-
B.G.3	Geconcentreerde veranderlijke belasting	-	-	1.50	-
B.G.4	Sneeuwbelasting	-	1.50	-	-
B.G.2.1	Verdeelde veranderlijke belasting	1.50	-	-	-

KARAKTERISTIEK BELASTINGSCOMBINATIES (TABEL)

B.G.	Omschrijving	Ka.C.(w1)	Ka.C.1	Ka.C.2	Ka.C.3
B.G.1	Permanent	1.00	1.00	1.00	1.00
B.G.2	Verdeelde veranderlijke belasting	-	-	-	-
B.G.3	Geconcentreerde veranderlijke belasting	-	-	-	-
B.G.4	Sneeuwbelasting	-	-	-	1.00
B.G.2.1	Verdeelde veranderlijke belasting	-	-	1.00	-

FREQUENT BELASTINGSCOMBINATIES (TABEL)

B.G.	Omschrijving	Fr.C.(w1)	Fr.C.1	Fr.C.2
B.G.1	Permanent	1.00	1.00	1.00
B.G.2	Verdeelde veranderlijke belasting	-	-	-
B.G.3	Geconcentreerde veranderlijke belasting	-	-	-
B.G.4	Sneeuwbelasting	-	-	0.20

B.G.2.1 Verdeelde veranderlijke belasting - - -

QUASI-PERMANENT BELASTINGSCOMBINATIES (TABEL)

B.G.	Omschrijving	Qu.C.1
B.G.1	Permanent	1.00
B.G.2	Verdeelde veranderlijke belasting	-
B.G.3	Geconcentreerde veranderlijke belasting	-
B.G.4	Sneeuwbelasting	-
B.G.2.1	Verdeelde veranderlijke belasting	-

UITGANGSPUNTEN VAN DE ANALYSE

Lineaire Elastische Analyse uitgevoerd

AFB. FU.C. MOMENT (MY) OMHULLENDE

Fundamenteel Belastingscombinaties

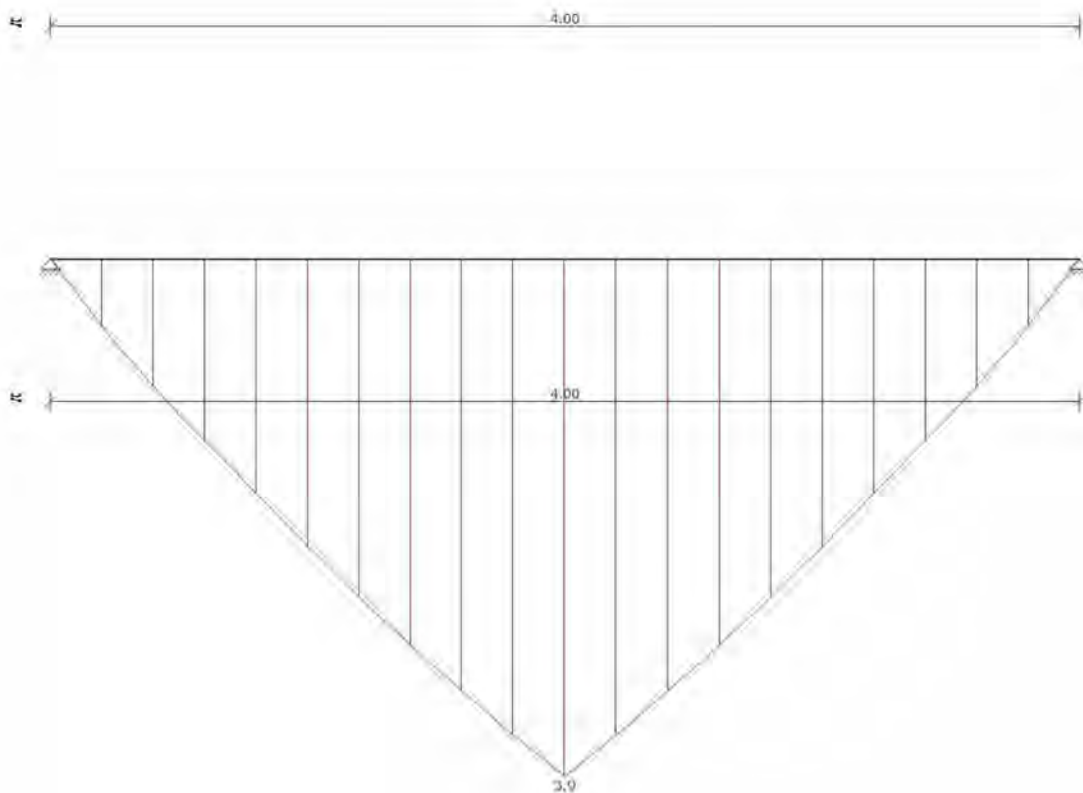

AFB. FU.C. DWARSKRACHT (VZ) OMHULLENDE

Fundamenteel Belastingscombinaties

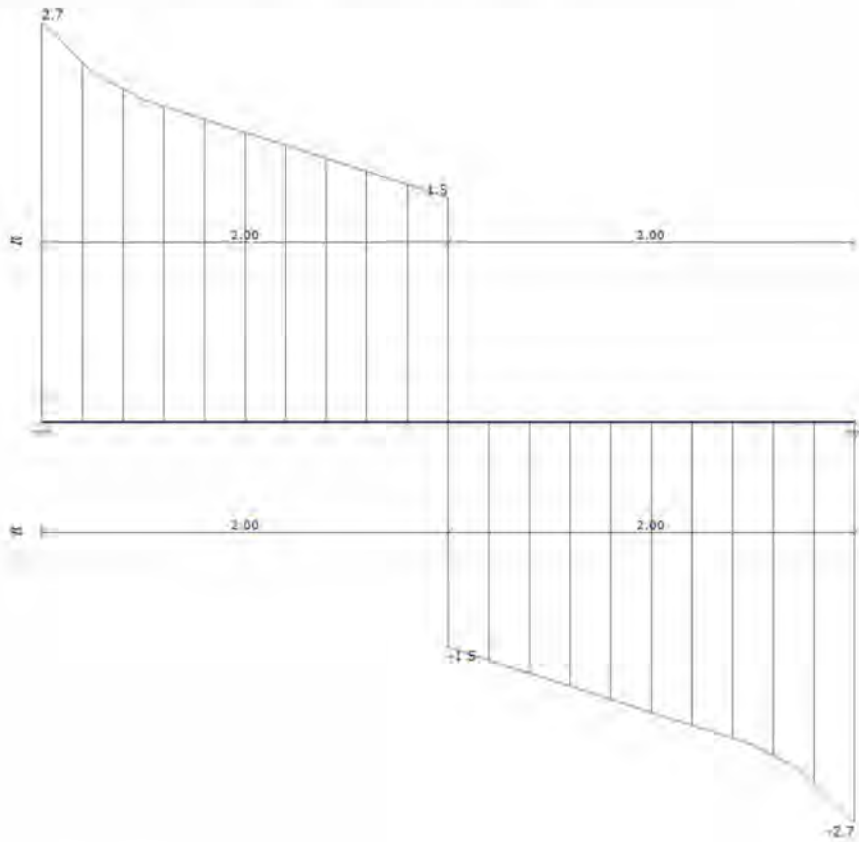

FU.C. STAAFKRACHTEN

Veld	Positie B.G. Ve	Mb	Mmax	xMmax	Me	x-M0	x-M0	Vb
Veld 1	0.000 - 4.000 Fu.C.1	0.00	2.67	2.000	0.00	0.000	0.000	2.67
2.67	-2.67							
	0.000 - 4.000 Fu.C.2	0.00	1.89	2.000	0.00	0.000	0.000	1.89
	1.89 -1.89							
	0.000 - 4.000 Fu.C.3	0.00	3.87	2.000	0.00	0.000	0.000	2.37
	2.37 -2.37							
	0.000 - 4.000 Fu.C.4	0.00	0.97	2.000	0.00	0.000	0.000	0.97
	0.97 -0.97							
-	m -	kNm	kNm	m	kNm	m	m	kN
kN	kN							

AFB. FU.C. OPLEGREACTIES OMHULLENDE

Fundamenteel Belastingscombinaties



FU.C. OPLEGREACTIES

B.C.	Oplegging	Positie	Z	Yr	Z	My
Fu.C.1	O1	0.000	vast	vrij	-2.67	0.00
Fu.C.1	O2	4.000	vast	vrij	-2.67	0.00
	Som Reacties				-5.33	
	Som Lasten				5.33	
Fu.C.2	O1	0.000	vast	vrij	-1.89	0.00
Fu.C.2	O2	4.000	vast	vrij	-1.89	0.00
	Som Reacties				-3.77	
	Som Lasten				3.77	
Fu.C.3	O1	0.000	vast	vrij	-2.37	0.00
Fu.C.3	O2	4.000	vast	vrij	-2.37	0.00
	Som Reacties				-4.73	
	Som Lasten				4.73	
Fu.C.4	O1	0.000	vast	vrij	-0.97	0.00
Fu.C.4	O2	4.000	vast	vrij	-0.97	0.00
	Som Reacties				-1.94	
	Som Lasten				1.94	
-	-	m	kN/m	kNm/rad	kN	kNm

B.G. OPLEGREACTIES

B.C.	Oplegging	Positie	Z	Yr	Z	My
B.G.1	O1	0.000	vast	vrij	-0.72	0.00
B.G.1	O2	4.000	vast	vrij	-0.72	0.00
	Som Reacties				-1.44	
	Som Lasten				1.44	
B.G.2.1	O1	0.000	vast	vrij	-1.20	0.00
B.G.2.1	O2	4.000	vast	vrij	-1.20	0.00
	Som Reacties				-2.40	
	Som Lasten				2.40	
B.G.3	O1	0.000	vast	vrij	-1.00	0.00
B.G.3	O2	4.000	vast	vrij	-1.00	0.00
	Som Reacties				-2.00	
	Som Lasten				2.00	
B.G.4	O1	0.000	vast	vrij	-0.68	0.00
B.G.4	O2	4.000	vast	vrij	-0.68	0.00
	Som Reacties				-1.36	
	Som Lasten				1.36	
-	-	m	kN/m	kNm/rad	kN	kNm

AFB. KA.C. VERPLAATSINGEN OMHULLENDE

Karakteristiek Belastingscombinaties



KA.C. KNOOPVERPLAATSINGEN

Knoop	B.C.	Z	Yr
K1	Ka.C.(w1)	0.0000	-3.045e-03
	Ka.C.1	0.0000	-3.045e-03
	Ka.C.2	0.0000	-8.121e-03
	Ka.C.3	0.0000	-5.921e-03
K2	Ka.C.(w1)	0.0000	3.045e-03
	Ka.C.1	0.0000	3.045e-03
	Ka.C.2	0.0000	8.121e-03
	Ka.C.3	0.0000	5.921e-03
-	-	m	rad

KA.C. DOORBUIGINGEN

Veld	Positie B.C.	Veld Begin	Z'afst	Veld Z'	Z' glb dist	Veld Eind Z' glb
S1	0.000 - 4.000 Ka.C.(w1)	0,0000	2.000	0,0038	2.000	0.0038 0,0000
S1	0.000 - 4.000 Ka.C.1	0,0000	2.000	0,0038	2.000	0.0038 0,0000
S1	0.000 - 4.000 Ka.C.2	0,0000	2.000	0,0102	2.000	0.0102 0,0000
S1	0.000 - 4.000 Ka.C.3	0,0000	2.000	0,0074	2.000	0.0074 0,0000
-	m -	m	m	m	m	m m

AFB. HOUTCONTROLE

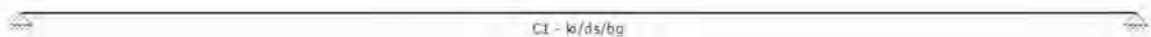

SAMENSTELLING CONSTRUCTIEDELEN

Constructiedeel	Staaft/staven
C1	S1

STABILITEITSGEGEVENS

Staaft	Profiel	Y-As (assenstelsel)			Z-As(assenstelsel)		
		Lsys Lkip/Lsys	Methode	Lkip	Lkip/Lsys	Methode	Lkip
C1 - V1 (0.000-4.000)	P1	4.000	Conservatief	4.000	1.00	Conservatief	4.000
1.00			geschoord			geschoord	
-	-	m -		m	-	-	m -

KIPSTEUNENGEGEVENS

Staaflast	Profiel	Begin	Eind	Kipsteunen boven	Kipsteunen onder	Aangrijppunt
C1 - V1 (0.000-4.000)	P1	inklemming	inklemming			Neutraal
-	-	Volledig vast	Volledig vast	m	m	-

DOORBUIGINGGEGEVENS

Staaflast	Constr.type	Toetsingstype	Zeeg Y'	Zeeg Z'	Zeegvorm	w;max
C1 - V1 (0.000-4.000)	Dak	Algemeen	0	0	Parabolisch	L/250
L/250	-	-	mm	mm	-	-

UNITY CHECK

Label	Toetsing	Combinatie	Artikel	UC max
C1	Doorsnede	Fu.C.3	NEN-EN1995-1-1#6.1.6 (6.11)	0.78
	Kip	Fu.C.3	NEN-EN1995-1-1#6.3.3 (6.33)	0.78
	Doorbuiging	Ka.C.2	NEN-EN1995#7.2 NEN-EN1990#A1.4.3(4)	0.78

8.2 Bijlage uitraai MatrixFrame berekening Pos 2

AFB. GEOMETRIE LIGGER

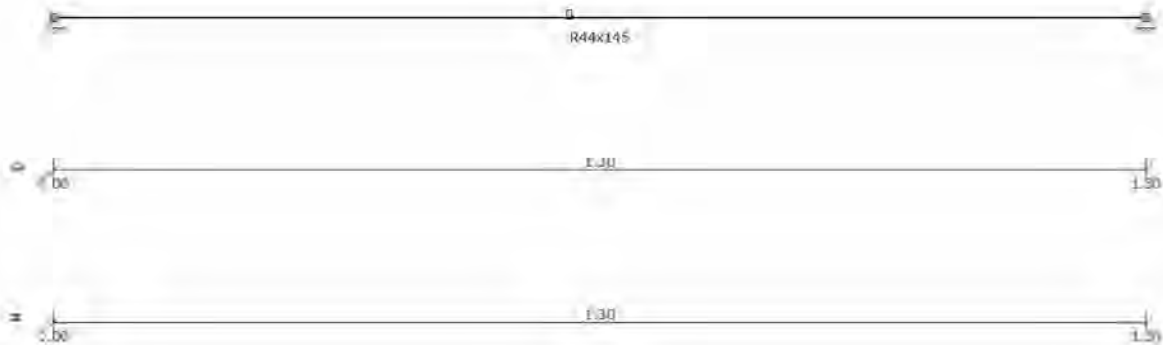

BALKGEOMETRIE

Positie	Profielnaam	5.1.2.e	Traagheidsmoment	Materiaal	E-Modulus	Uitzettingcoeff
0.000 - L(1.300)	R44x145	0	1.1178e-05	C24	1.1000e+07	50.0000e-07
0.03						
	m -		m ⁴ -		kN/m ²	C°m
	kN/m					

PROFIELVORMEN

Profiel	Verl. h.	hB	hE	tf	tw	tf2	B	bL	bR	Raatl.
P2	Nee	0,145	0,145	0,0000	0,0000	0,0000	0,044	0,000	0,000	Nee 0,000
-	-	m	m	m	m	m	m	m	m	m - m

MATERIALEN

Materiaalnaam	Poison	Dichtheid	E-Modulus	Uitzettingcoeff
C24	0.40	4.20	1.1000e+07	50.0000e-07
-	-	kN/m ³	kN/m ²	C°m

OPLEGGINGEN

Oplegging	Positie	Z	Yr
O1	0.000	vast	vrij
O2	L(1.300)	vast	vrij
-	m	kN/m	kNm/rad

BELASTINGSGEVALLEN TYPEN

Oplegg.	Staven	5.1.2.e	Gunstig/Ong. Element	5.1.2.e	Psi0	Psi1	Cprob
Psi2	UGT/GGT						
B.G.1	Permanent	Permanent	-	N.v.t.	N.v.t.		
B.G.2	Verdeelde veranderlijke belasting	Verdeelde	-	Cat. H) Ontoegankelijke daken	1	1	
B.G.3	Geconcentreerde veranderlijke belasting	Geconcentreerde	-	Cat. H) Ontoegankelijke daken	N.v.t.	N.v.t.	
B.G.4	Sneeuwbelasting	Sneeuwbelasting	-	N.v.t.	N.v.t.		0.20
1.00/1.00							
B.G.2.1	Verdeelde veranderlijke belasting	Verdeelde	-	Cat. H) Ontoegankelijke daken	1	1	
1.00/1.00							

belasting

veranderlijke
belasting

daken

AFB. LASTEN B.G.1 PERMANENT

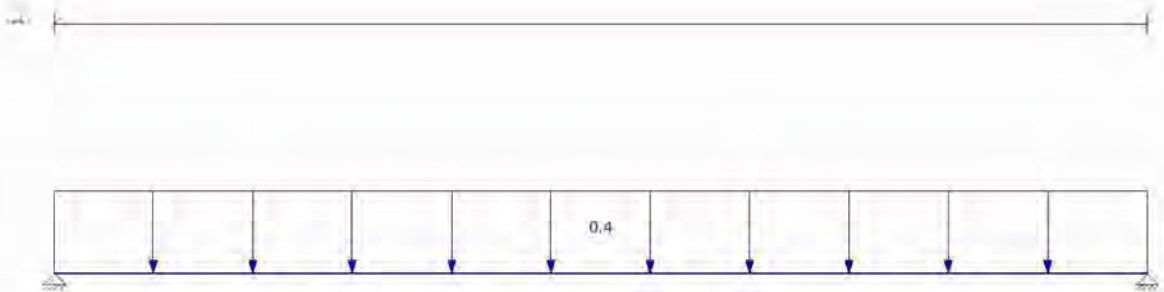

AFB. LASTEN B.G.2 VERDEELDE VERANDERLIJKE BELASTING

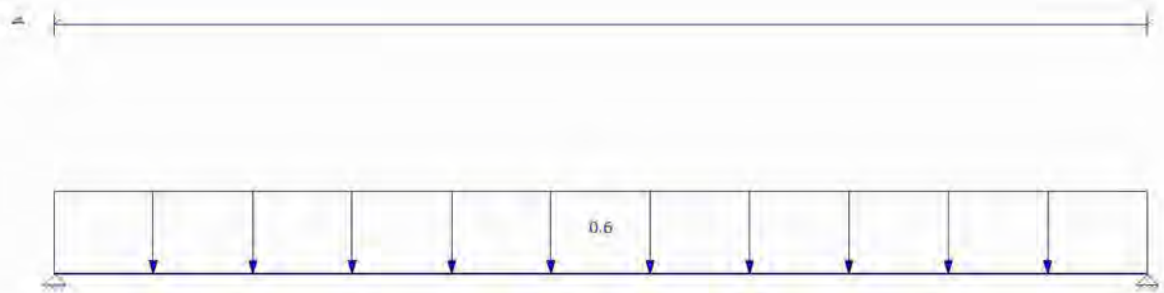

AFB. LASTEN B.G.3 GECONCENTREERDE VERANDERLIJKE BELASTING

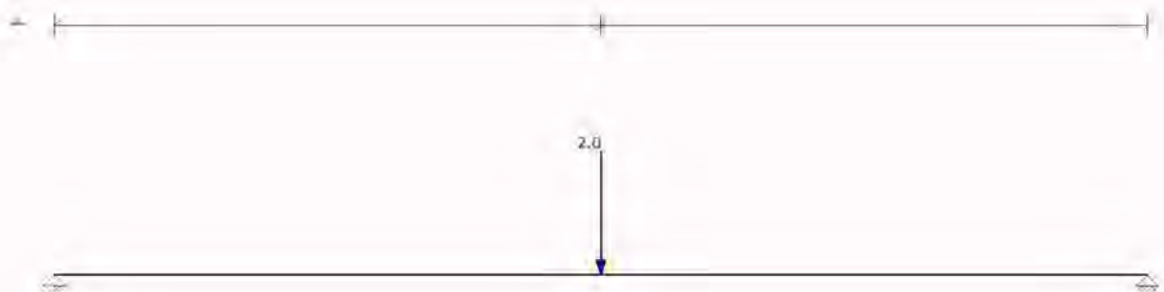

AFB. LASTEN B.G.4 SNEEUWBELASTING

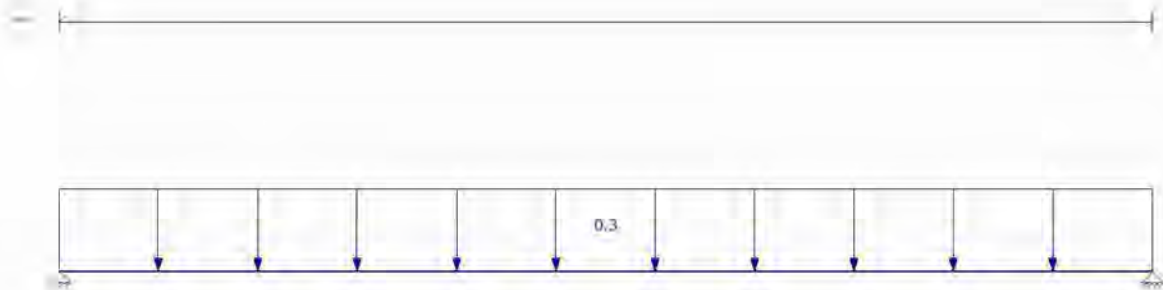

AFB. LASTEN B.G.2.1 VERDEELDE VERANDERLIJKE BELASTING

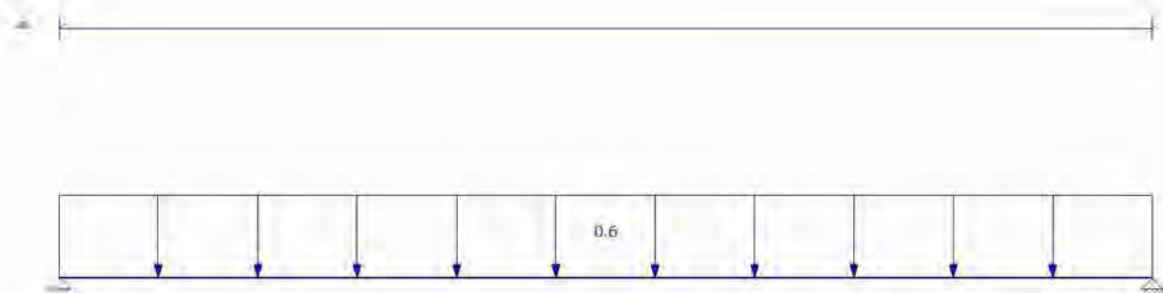

FUNDAMENTEEL BELASTINGSCOMBINATIES (TABEL)

B.G.	Omschrijving	Fu.C.1	Fu.C.2	Fu.C.3	Fu.C.4
B.G.1	Permanent	1.20	1.20	1.20	1.35
B.G.2	Verdeelde veranderlijke belasting	-	-	-	-
B.G.3	Geconcentreerde veranderlijke belasting	-	-	1.50	-
B.G.4	Sneeuwbelasting	-	1.50	-	-
B.G.2.1	Verdeelde veranderlijke belasting	1.50	-	-	-

KARAKTERISTIEK BELASTINGSCOMBINATIES (TABEL)

B.G.	Omschrijving	Ka.C.(w1)	Ka.C.1	Ka.C.2	Ka.C.3
B.G.1	Permanent	1.00	1.00	1.00	1.00
B.G.2	Verdeelde veranderlijke belasting	-	-	-	-
B.G.3	Geconcentreerde veranderlijke belasting	-	-	-	-
B.G.4	Sneeuwbelasting	-	-	-	1.00
B.G.2.1	Verdeelde veranderlijke belasting	-	-	1.00	-

FREQUENT BELASTINGSCOMBINATIES (TABEL)

B.G.	Omschrijving	Fr.C.(w1)	Fr.C.1	Fr.C.2
B.G.1	Permanent	1.00	1.00	1.00
B.G.2	Verdeelde veranderlijke belasting	-	-	-
B.G.3	Geconcentreerde veranderlijke belasting	-	-	-
B.G.4	Sneeuwbelasting	-	-	0.20

B.G.2.1 Verdeelde veranderlijke belasting - - -

QUASI-PERMANENT BELASTINGSCOMBINATIES (TABEL)

B.G.	Omschrijving	Qu.C.1
B.G.1	Permanent	1.00
B.G.2	Verdeelde veranderlijke belasting	-
B.G.3	Geconcentreerde veranderlijke belasting	-
B.G.4	Sneeuwbelasting	-
B.G.2.1	Verdeelde veranderlijke belasting	-

UITGANGSPUNTEN VAN DE ANALYSE

Lineaire Elastische Analyse uitgevoerd

AFB. FU.C. MOMENT (MY) OMHULLENDE

Fundamenteel Belastingscombinaties

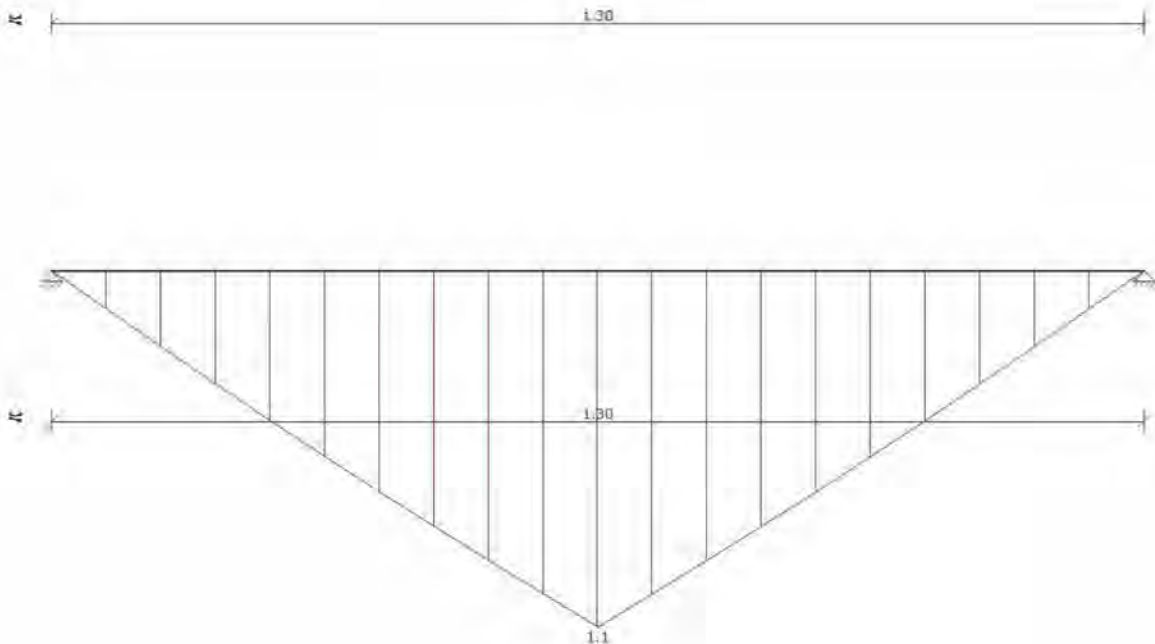

AFB. FU.C. DWARSKRACHT (VZ) OMHULLENDE

Fundamenteel Belastingscombinaties

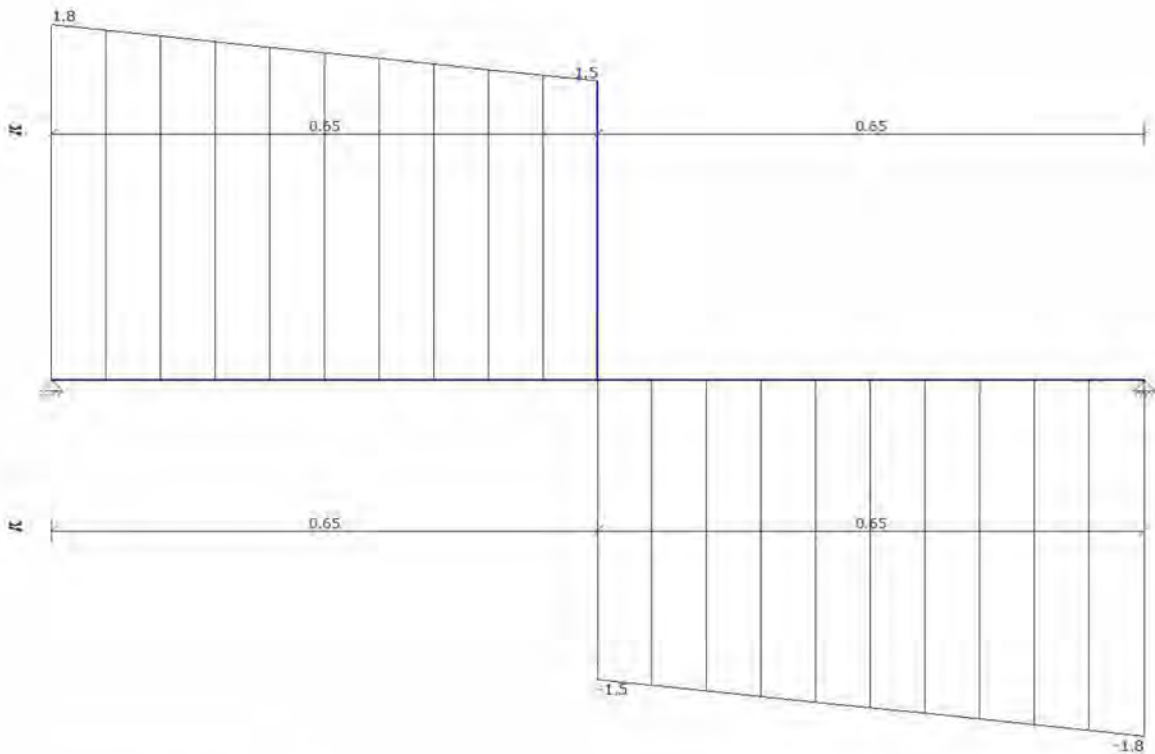

FU.C. STAAFKRACHTEN

Veld	Positie B.G. Ve	Mb	Mmax	xMmax	Me	x-M0	x-M0	Vb
Veld 1	0.000 - 1.300 Fu.C.1	0.00	0.28	0.650	0.00	0.000	0.000	0.87
0.87	-0.87							
	0.000 - 1.300 Fu.C.2	0.00	0.20	0.650	0.00	0.000	0.000	0.61
	-0.61 -0.61							
	0.000 - 1.300 Fu.C.3	0.00	1.07	0.650	0.00	0.000	0.000	1.78
	-1.78 -1.78							
	0.000 - 1.300 Fu.C.4	0.00	0.10	0.650	0.00	0.000	0.000	0.32
	0.32 -0.32							
-	m -	kNm	kNm	m	kNm	m	m	kN
kN	kN							

AFB. FU.C. OPLEGREACTIES OMHULLENDE

Fundamenteel Belastingscombinaties



FU.C. OPLEGREACTIES

B.C.	Oplegging	Positie	Z	Yr	Z	My
Fu.C.1	O1	0.000	vast	vrij	-0.87	0.00
Fu.C.1	O2	1.300	vast	vrij	-0.87	0.00
	Som Reacties				-1.73	
	Som Lasten				1.73	
Fu.C.2	O1	0.000	vast	vrij	-0.61	0.00
Fu.C.2	O2	1.300	vast	vrij	-0.61	0.00
	Som Reacties				-1.23	
	Som Lasten				1.23	
Fu.C.3	O1	0.000	vast	vrij	-1.78	0.00
Fu.C.3	O2	1.300	vast	vrij	-1.78	0.00
	Som Reacties				-3.56	
	Som Lasten				3.56	
Fu.C.4	O1	0.000	vast	vrij	-0.32	0.00
Fu.C.4	O2	1.300	vast	vrij	-0.32	0.00
	Som Reacties				-0.63	
	Som Lasten				0.63	
-	-	m	kN/m	kNm/rad	kN	kNm

B.G. OPLEGREACTIES

B.C.	Oplegging	Positie	Z	Yr	Z	My
B.G.1	O1	0.000	vast	vrij	-0.23	0.00
B.G.1	O2	1.300	vast	vrij	-0.23	0.00
	Som Reacties				-0.47	
	Som Lasten				0.47	
B.G.2.1	O1	0.000	vast	vrij	-0.39	0.00
B.G.2.1	O2	1.300	vast	vrij	-0.39	0.00
	Som Reacties				-0.78	
	Som Lasten				0.78	
B.G.3	O1	0.000	vast	vrij	-1.00	0.00
B.G.3	O2	1.300	vast	vrij	-1.00	0.00
	Som Reacties				-2.00	
	Som Lasten				2.00	
B.G.4	O1	0.000	vast	vrij	-0.22	0.00
B.G.4	O2	1.300	vast	vrij	-0.22	0.00
	Som Reacties				-0.44	
	Som Lasten				0.44	
-	-	m	kN/m	kNm/rad	kN	kNm

AFB. KA.C. VERPLAATSINGEN OMHULLENDE

Karakteristiek Belastingscombinaties



KA.C. KNOOPVERPLAATSINGEN

Knoop	B.C.	Z	Yr
K1	Ka.C.(w1)	0.0000	-0.268e-03
	Ka.C.1	0.0000	-0.268e-03
	Ka.C.2	0.0000	-0.715e-03

Knoop	B.C.	Z	Yr
K1	Ka.C.3	0.0000	-0.521e-03
K2	Ka.C.(w1)	0.0000	0.268e-03
	Ka.C.1	0.0000	0.268e-03
	Ka.C.2	0.0000	0.715e-03
	Ka.C.3	0.0000	0.521e-03
-	-	m	rad

KA.C. DOORBUIGINGEN

Veld	Positie B.C.	Veld Begin	Veld		Veld Eind	
			Z'afst	Z' Z' glb dist	Z' glb	Z' glb
S1	0.000 - 1.300 Ka.C.(w1)	0,0000	0.650	0,0001	0.650	0.0001 0,0000
S1	0.000 - 1.300 Ka.C.1	0,0000	0.650	0,0001	0.650	0.0001 0,0000
S1	0.000 - 1.300 Ka.C.2	0,0000	0.650	0,0003	0.650	0.0003 0,0000
S1	0.000 - 1.300 Ka.C.3	0,0000	0.650	0,0002	0.650	0.0002 0,0000
-	m -	m	m	m	m	m m

AFB. HOUTCONTROLE

C1 - k/ds/bg

SAMENSTELLING CONSTRUCTIEDELEN

Constructiedeel	Staal/staven
C1	S1

STABILITEITSGEGEVENS

Staal	Profiel	Y-As (assenstelsel)			Z-As(assenstelsel)		
		Lsys Lkip/Lsys	Methode	Lkip	Lkip/Lsys	Methode	Lkip
C1 - V1 (0.000-1.300)	P2	1.300	Conservatief	1.300	1.00	Conservatief	1.300
1.00			geschoord			geschoord	
-	-	m -		m	-	-	m -

KIPSTEUNENEGEVENS

Staal last	Profiel	Begin	Eind	Kipsteunen boven	Kipsteunen onder	Aangrijppunt
C1 - V1 (0.000-1.300)	P2	inklemming	inklemming			Neutraal
-	-	Volledig vast	Volledig vast	m	m	-

DOORBUIGINGGEGEVENS

Staal w;2+w;3	Constr.type	Toetsingstype	Zeeg Y'	Zeeg Z'	Zeegvorm	w;max
C1 - V1 (0.000-1.300)	Dak	Algemeen	0	0	Parabolisch	L/250
L/250			mm	mm	-	-

UNITY CHECK

Label	Toetsing	Combinatie	Artikel	UC max
C1	Doorsnede	Fu.C.3	NEN-EN1995-1-1#6.1.6 (6.11)	0.47
	Kip	Fu.C.3	NEN-EN1995-1-1#6.3.3 (6.33)	0.47
	Doorbuiging	Ka.C.2	NEN-EN1995#7.2 NEN-EN1990#A1.4.3(4)	0.07

8.3 Bijlage uitraai MatrixFrame berekening Pos 3

AFB. GEOMETRIE LIGGER

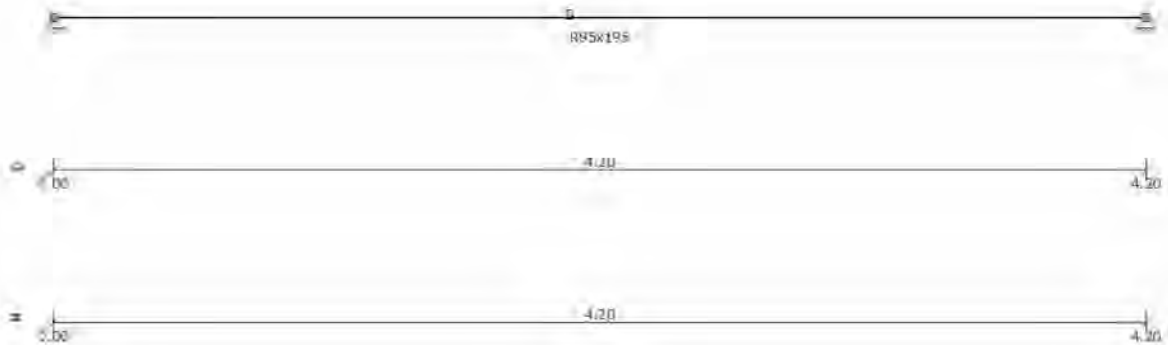

BALKGEOMETRIE

Positie	Profielnaam	5.1.2.e	Traagheidsmoment	Materiaal	E-Modulus	Uitzettingcoeff
0,000 - L(4.200)	R95x195	0	5.8701e-05	C24	1.1000e+07	50.0000e-07
0.08						
	m -			m4 -	kN/m2	C°m
	kN/m					

PROFIELVORMEN

Profiel	Verl. h.	hB	hE	tf	tw	tf2	B	bL	bR	Raatl.
P6	Nee	0,195	0,195	0,0000	0,0000	0,0000	0,095	0,000	0,000	Nee
-	-	m	m	m	m	m	m	m	m	m

MATERIALEN

Materiaalnaam	Poison	Dichtheid	E-Modulus	Uitzettingcoeff
C24	0.40	4.20	1.1000e+07	50.0000e-07
-	-	kN/m3	kN/m2	C°m

OPLEGGINGEN

Oplegging	Positie	Z	Yr
O1	0.000	vast	vrij
O2	L(4.200)	vast	vrij
-	m	kN/m	kNm/rad

BELASTINGSGEVALLEN TYPEN

Oplegg.	Staven	5.1.2.e	Gunstig/Ong.	Element	5.1.2.e	Psi0	Psi1	Cprob
B.G.1	Permanent	Permanent	-		N.v.t.	N.v.t.		
B.G.2	Verdeelde veranderlijke belasting	Verdeelde	-	Cat. H) Ontoegankelijke daken	1	1		
B.G.3	Geconcentreerde veranderlijke belasting	Geconcentreerde	-	Cat. H) Ontoegankelijke daken	N.v.t.	N.v.t.		
B.G.4	Sneeuwbelasting	Sneeuwbelasting	-		N.v.t.	N.v.t.	0.20	
B.G.2.1	Verdeelde veranderlijke belasting	Verdeelde	-	Cat. H) Ontoegankelijke	1	1		

belasting

veranderlijke
belasting

daken

AFB. LASTEN B.G.1 PERMANENT

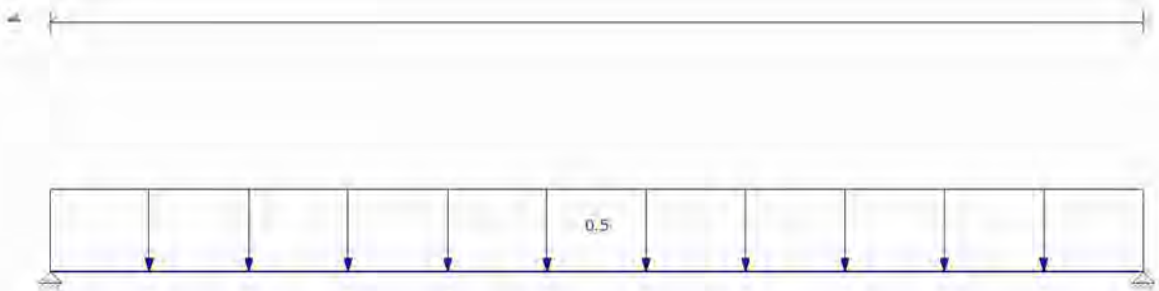

AFB. LASTEN B.G.2 VERDEELDE VERANDERLIJKE BELASTING

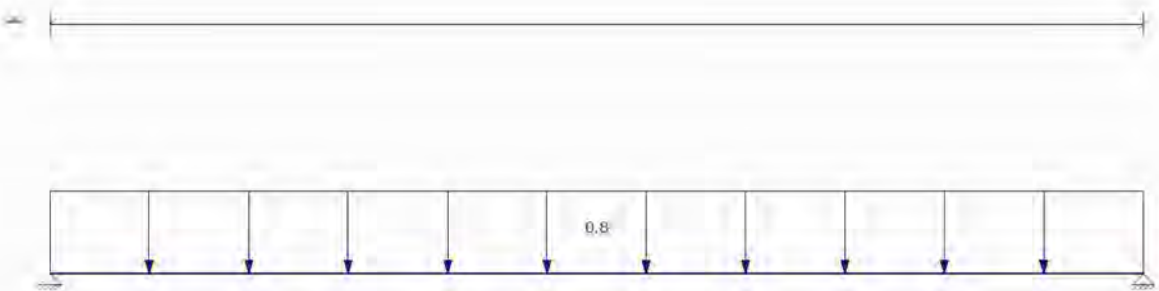

AFB. LASTEN B.G.3 GECONCENTREERDE VERANDERLIJKE BELASTING

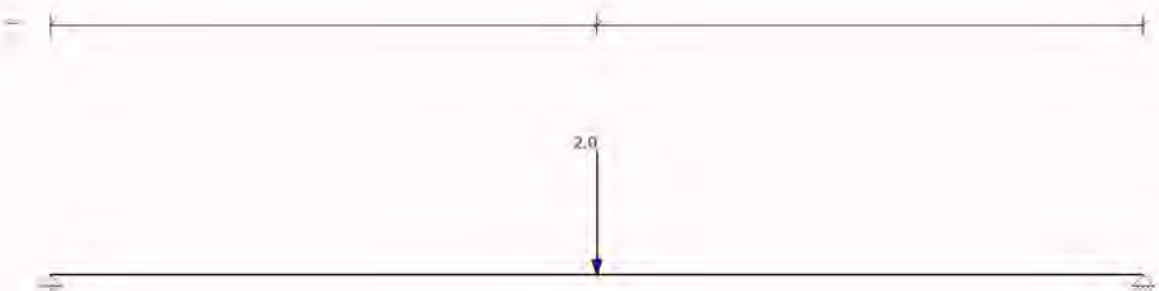

AFB. LASTEN B.G.4 SNEEUWBELASTING

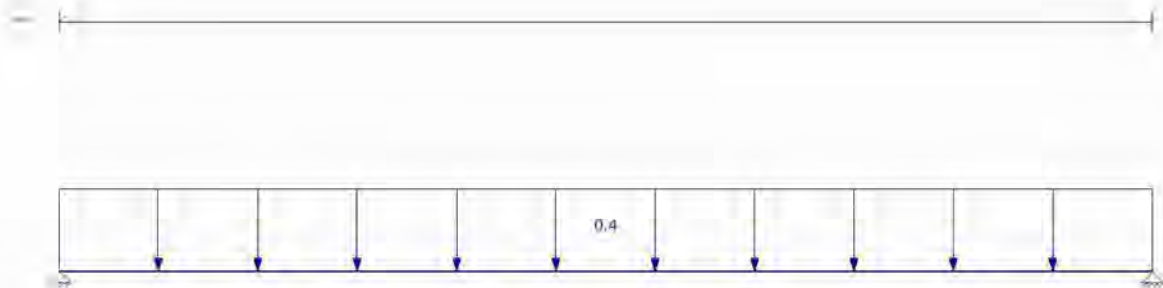

AFB. LASTEN B.G.2.1 VERDEELDE VERANDERLIJKE BELASTING

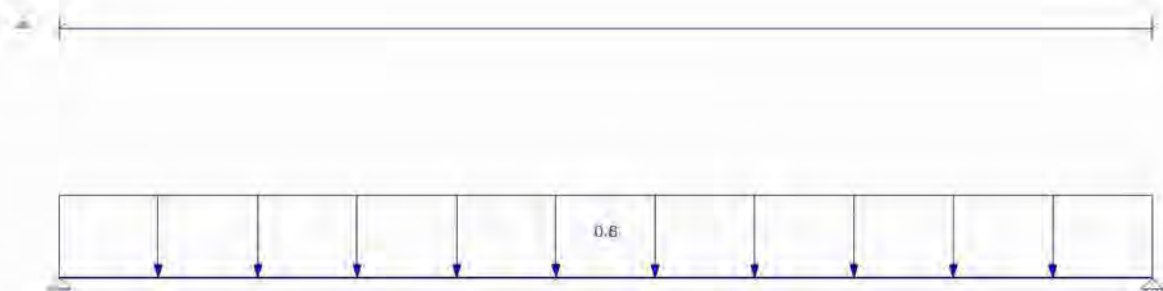

FUNDAMENTEEL BELASTINGSCOMBINATIES (TABEL)

B.G.	Omschrijving	Fu.C.1	Fu.C.2	Fu.C.3	Fu.C.4
B.G.1	Permanent	1.20	1.20	1.20	1.35
B.G.2	Verdeelde veranderlijke belasting	-	-	-	-
B.G.3	Geconcentreerde veranderlijke belasting	-	-	1.50	-
B.G.4	Sneeuwbelasting	-	1.50	-	-
B.G.2.1	Verdeelde veranderlijke belasting	1.50	-	-	-

KARAKTERISTIEK BELASTINGSCOMBINATIES (TABEL)

B.G.	Omschrijving	Ka.C.(w1)	Ka.C.1	Ka.C.2	Ka.C.3
B.G.1	Permanent	1.00	1.00	1.00	1.00
B.G.2	Verdeelde veranderlijke belasting	-	-	-	-
B.G.3	Geconcentreerde veranderlijke belasting	-	-	-	-
B.G.4	Sneeuwbelasting	-	-	-	1.00
B.G.2.1	Verdeelde veranderlijke belasting	-	-	1.00	-

FREQUENT BELASTINGSCOMBINATIES (TABEL)

B.G.	Omschrijving	Fr.C.(w1)	Fr.C.1	Fr.C.2
B.G.1	Permanent	1.00	1.00	1.00
B.G.2	Verdeelde veranderlijke belasting	-	-	-
B.G.3	Geconcentreerde veranderlijke belasting	-	-	-
B.G.4	Sneeuwbelasting	-	-	0.20

B.G.2.1 Verdeelde veranderlijke belasting - - -

QUASI-PERMANENT BELASTINGSCOMBINATIES (TABEL)

B.G.	Omschrijving	Qu.C.1
B.G.1	Permanent	1.00
B.G.2	Verdeelde veranderlijke belasting	-
B.G.3	Geconcentreerde veranderlijke belasting	-
B.G.4	Sneeuwbelasting	-
B.G.2.1	Verdeelde veranderlijke belasting	-

UITGANGSPUNTEN VAN DE ANALYSE

Lineaire Elastische Analyse uitgevoerd

AFB. FU.C. MOMENT (MY) OMHULLENDE

Fundamenteel Belastingscombinaties

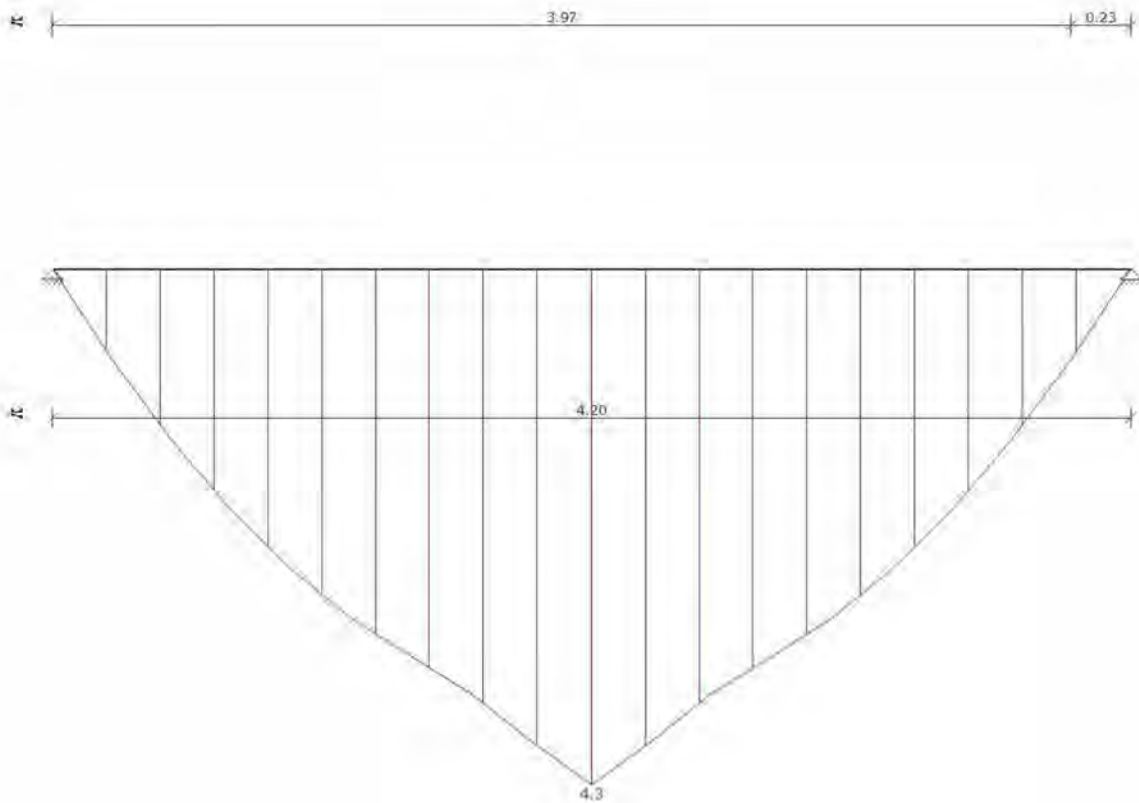

AFB. FU.C. DWARSKRACHT (VZ) OMHULLENDE

Fundamenteel Belastingscombinaties

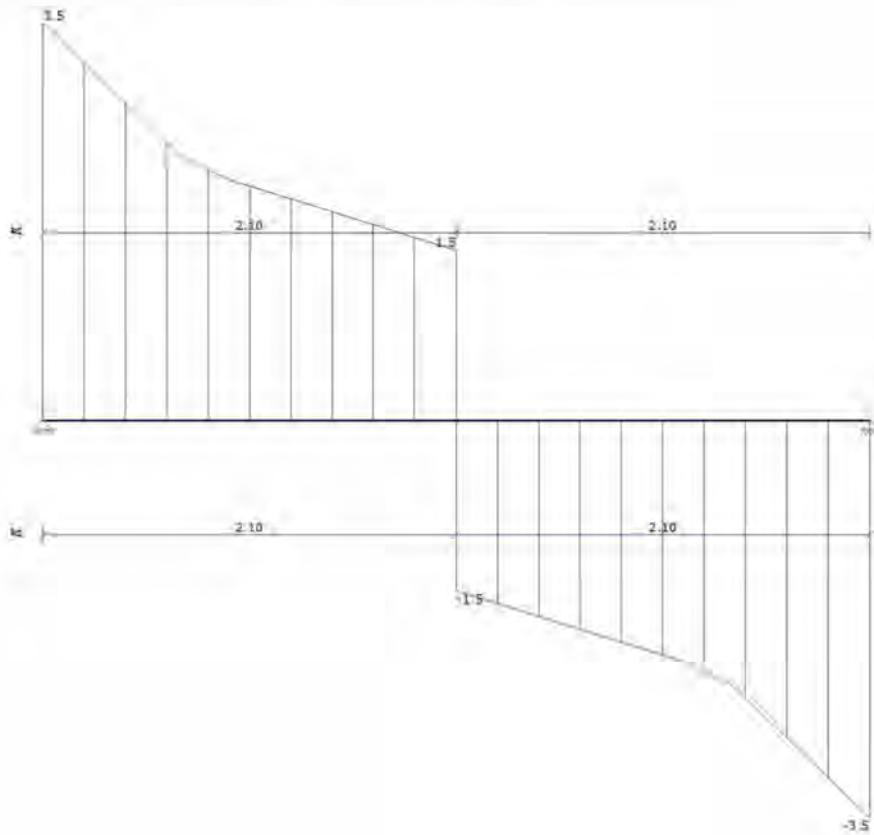

FU.C. STAAFKRACHTEN

Veld	Positie B.G.	Mb	Mmax	xMmax	Me	x-M0	x-M0	Vb
Vmax	Ve							
Veld 1	0.000 - 4.200 Fu.C.1	0.00	3.67	2.100	0.00	0.000	0.000	3.50
3.50	-3.50							
	0.000 - 4.200 Fu.C.2	0.00	2.58	2.100	0.00	0.000	0.000	2.46
	2.46 - 2.46							
	0.000 - 4.200 Fu.C.3	0.00	4.34	2.100	0.00	0.000	0.000	5.1.2.e
	5.1.2.e 5.1.2.e							
	0.000 - 4.200 Fu.C.4	0.00	1.34	2.100	0.00	0.000	0.000	1.28
	1.28 - 1.28							
-	m -	kNm	kNm	m	kNm	m	m	kN
kN	kN							

AFB. FU.C. OPLEGREACTIES OMHULLENDE

Fundamenteel Belastingscombinaties



FU.C. OPLEGREACTIES

B.C.	Oplegging	Positie	Z	Yr	Z	My
Fu.C.1	O1	0.000	vast	vrij	-3.50	0.00
Fu.C.1	O2	4.200	vast	vrij	-3.50	0.00
	Som Reacties				-7.00	
	Som Lasten				7.00	
Fu.C.2	O1	0.000	vast	vrij	-2.46	0.00
Fu.C.2	O2	4.200	vast	vrij	-2.46	0.00
	Som Reacties				-4.92	
	Som Lasten				4.92	
Fu.C.3	O1	0.000	vast	vrij	5.1.2.e	0.00
Fu.C.3	O2	4.200	vast	vrij	5.1.2.e	0.00
	Som Reacties				-5.27	
	Som Lasten				5.27	
Fu.C.4	O1	0.000	vast	vrij	-1.28	0.00
Fu.C.4	O2	4.200	vast	vrij	-1.28	0.00
	Som Reacties				-2.55	
	Som Lasten				2.55	
-	-	m	kN/m	kNm/rad	kN	kNm

B.G. OPLEGREACTIES

B.C.	Oplegging	Positie	Z	Yr	Z	My
B.G.1	O1	0.000	vast	vrij	-0.95	0.00
B.G.1	O2	4.200	vast	vrij	-0.95	0.00
	Som Reacties				-1.89	
	Som Lasten				1.89	
B.G.2.1	O1	0.000	vast	vrij	-1.58	0.00
B.G.2.1	O2	4.200	vast	vrij	-1.58	0.00
	Som Reacties				-3.15	
	Som Lasten				3.15	
B.G.3	O1	0.000	vast	vrij	-1.00	0.00
B.G.3	O2	4.200	vast	vrij	-1.00	0.00
	Som Reacties				-2.00	
	Som Lasten				2.00	
B.G.4	O1	0.000	vast	vrij	-0.88	0.00
B.G.4	O2	4.200	vast	vrij	-0.88	0.00
	Som Reacties				-1.76	
	Som Lasten				1.76	
-	-	m	kN/m	kNm/rad	kN	kNm

AFB. KA.C. VERPLAATSINGEN OMHULLENDE

Karakteristiek Belastingscombinaties



KA.C. KNOOPVERPLAATSINGEN

Knoop	B.C.	Z	Yr
K1	Ka.C.(w1)	0.0000	-2.151e-03
	Ka.C.1	0.0000	-2.151e-03
	Ka.C.2	0.0000	-5.737e-03
	Ka.C.3	0.0000	-4.159e-03
K2	Ka.C.(w1)	0.0000	2.151e-03
	Ka.C.1	0.0000	2.151e-03
	Ka.C.2	0.0000	5.737e-03
	Ka.C.3	0.0000	4.159e-03
-	-	m	rad

KA.C. DOORBUIGINGEN

Veld	Positie B.C.	Veld Begin	Z'afst	Veld Z'	Z' glb dist	Veld Eind	Z' glb
S1	0.000 - 4.200 Ka.C.(w1)	0,0000	2.100	0,0028	2.100	0.0028	0,0000
S1	0.000 - 4.200 Ka.C.1	0,0000	2.100	0,0028	2.100	0.0028	0,0000
S1	0.000 - 4.200 Ka.C.2	0,0000	2.100	0,0075	2.100	0.0075	0,0000
S1	0.000 - 4.200 Ka.C.3	0,0000	2.100	0,0055	2.100	0.0055	0,0000
-	m -	m	m	m	m	m	m

AFB. HOUTCONTROLE

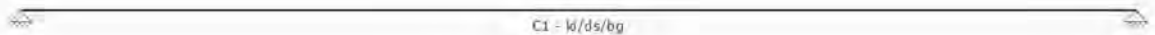

SAMENSTELLING CONSTRUCTIEDELEN

Constructiedeel	Staal/staven
C1	S1

STABILITEITSGEGEVENS

Staal	Profiel	Y-As (assenstelsel)			Z-As(assenstelsel)		
		Lsys Lkip/Lsys	Methode	Lkip	Lkip/Lsys	Methode	Lkip
C1 - V1 (0.000-4.200)	P6	4.200	Conservatief	4,200	1.00	Conservatief	4.200
1.00			geschoord			geschoord	
-	-	m -		m	-	-	m -

KIPSTEUNENGEGEVENS

Staaflast	Profiel	Begin	Eind	Kipsteunen boven	Kipsteunen onder	Aangrijppunt
C1 - V1 (0.000-4.200)	P6	inklemming	inklemming			Neutraal
-	-	Volledig vast	Volledig vast	m	m	-

DOORBUIGINGGEGEVENS

Staaflast	Constr.type	Toetsingstype	Zeeg Y'	Zeeg Z'	Zeegvorm	w;max
C1 - V1 (0.000-4.200)	Dak	Algemeen	0	0	Parabolisch	L/250
L/250	-	-	mm	mm	-	-

UNITY CHECK

Label	Toetsing	Combinatie	Artikel	UC max
C1	Doorsnede	Fu.C.3	NEN-EN1995-1-1#6.1.6 (6.11)	0.49
	Kip	Fu.C.3	NEN-EN1995-1-1#6.3.3 (6.33)	0.49
	Doorbuiging	Ka.C.2	NEN-EN1995#7.2 NEN-EN1990#A1.4.3(4)	0.55

8.4 Bijlage uitraai MatrixFrame berekening Pos 4

AFB. GEOMETRIE RAAMWERK



STAVEN

StAAF	Knoop B	Knoop E	X-B	Z-B	X-E	Z-E	Lengte	Profiel
S1	K1	K2	0.000	0.000	0.000	-2.400	2.400	P1
0.000 - L(2.400)								
-	-	-	m	m	m	m	m	-

PROFIELEN

Profiel	Profielnaam	Oppervlakte	Iy	Materiaal	5.1.2.e
P1	R38x120	4.5600e-03	5.4720e-06	C24	0.0
-	-	m ²	m ⁴	-	°

PROFIELVORMEN

Profiel	Verl. h.	hB	hE	tf	tw	tf2	B	bL	bR	Raatl.
P1	Nee	0,120	0,120	0,0000	0,0000	0,0000	0,038	0,000	0,000	Nee 0,000
-	-	m	m	m	m	m	m	m	m	m

MATERIALEN

Materiaal	Dichtheid	E-Modulus	Uitzettingcoeff
C24	4.20	1.1000e+07	50.0000e-07
-	kN/m ³	kN/m ²	C°m

OPLEGGINGEN

Oplegging	Object	Positie	Z	Yr	HoekYr
O1	K1	0.000	vast	vast	vrij 0
O2	K2	0.000	vast	0.00:0.00	vrij 0
-	-	m	kN/m	kN/m	kNm/rad °

BELASTINGSGEVALLEN TYPEN

Oplegg.	Staven	5.1.2.e	Gunstig/Ong.	Element	5.1.2.e	Psi0	Psi1	Cprob
B.G.1	Permanent	Permanent	-		N.v.t.	N.v.t.		
B.G.2	Geconcentreerde	Geconcentreerde	-	Cat. H) Ontoegankelijke	N.v.t.	N.v.t.		
	veranderlijke belasting	veranderlijke belasting		daken				
B.G.3	Windbelasting	Windbelasting	-		N.v.t.	N.v.t.	0.20	
1.00/1.00								
B.G.4	Kniklengte (Assymetrisch)	Kniklengte			N.v.t.	N.v.t.		
B.G.5	Kniklengte (Symmetrisch)	Kniklengte			N.v.t.	N.v.t.		

FUNDAMENTEEL BELASTINGSCOMBINATIES (TABEL)

B.G.	Omschrijving	Fu.C.1	Fu.C.2	Fu.C.3
B.G.1	Permanent	1.20	1.20	1.35
B.G.2	Geconcentreerde veranderlijke belasting	-	1.50	-
B.G.3	Windbelasting	1.50	-	-
B.G.4	Kniklengte (Assymetrisch)	-	-	-
B.G.5	Kniklengte (Symmetrisch)	-	-	-

KARAKTERISTIEK BELASTINGSCOMBINATIES (TABEL)

B.G.	Omschrijving	Ka.C.(w1)	Ka.C.1	Ka.C.2
------	--------------	-----------	--------	--------

B.G.1	Permanent	1.00	1.00	1.00
B.G.2	Geconcentreerde veranderlijke belasting	-	-	-
B.G.3	Windbelasting	-	-	1.00
B.G.4	Kniklengte (Assymetrisch)	-	-	-
B.G.5	Kniklengte (Symmetrisch)	-	-	-

FREQUENT BELASTINGSCOMBINATIES (TABEL)

B.G.	Omschrijving	Fr.C.(w1)	Fr.C.1
B.G.1	Permanent	1.00	1.00
B.G.2	Geconcentreerde veranderlijke belasting	-	-
B.G.3	Windbelasting	-	0.20
B.G.4	Kniklengte (Assymetrisch)	-	-
B.G.5	Kniklengte (Symmetrisch)	-	-

QUASI-PERMANENT BELASTINGSCOMBINATIES (TABEL)

B.G.	Omschrijving	Qu.C.1
B.G.1	Permanent	1.00
B.G.2	Geconcentreerde veranderlijke belasting	-
B.G.3	Windbelasting	-
B.G.4	Kniklengte (Assymetrisch)	-
B.G.5	Kniklengte (Symmetrisch)	-

UITGANGSPUNTEN VAN DE ANALYSE

Lineaire Elastische Analyse uitgevoerd

AFB. HOUTCONTRÔLE



SAMENSTELLING CONSTRUCTIEDELEN

Constructiedeel	Staal/staven
C1	S1

STABILITEITSGEGEVENS

Staal	Profiel	Y-As (assenstelsel)			Z-As(assenstelsel)		
		Lsys Lkip/Lsys	Methode	Lkip	Lkip/Lsys	Methode	Lkip
C1 - V1 (0.000-2.400) 0.10	P1	2.400	Geschoord	2.310	0.96	Handmatige Invoer	0.240
-	-	m	-	m	-	-	m

KIPSTEUNENGEDEVENS

Staal last	Profiel	Begin	Eind	Kipsteunen boven	Kipsteunen onder	Aangrijppunt
C1 - V1 (0.000-2.400)	P1	inklemming	inklemming			Neutraal
-	-	Volledig vast	Volledig vast	m	m	-

DOORBUIGINGGEGEVENS

Staal w;2+w;3	Constr.type	Toetsingstype	Zeeg Y'	Zeeg Z'	Zeegvorm	w;max
C1 - V1 (0.000-2.400)	Kolom	1 bouwlaag			Parabolisch	H/300
-	-	-	mm	mm	-	N/B

AFB. HOUT UC DIAGRAM

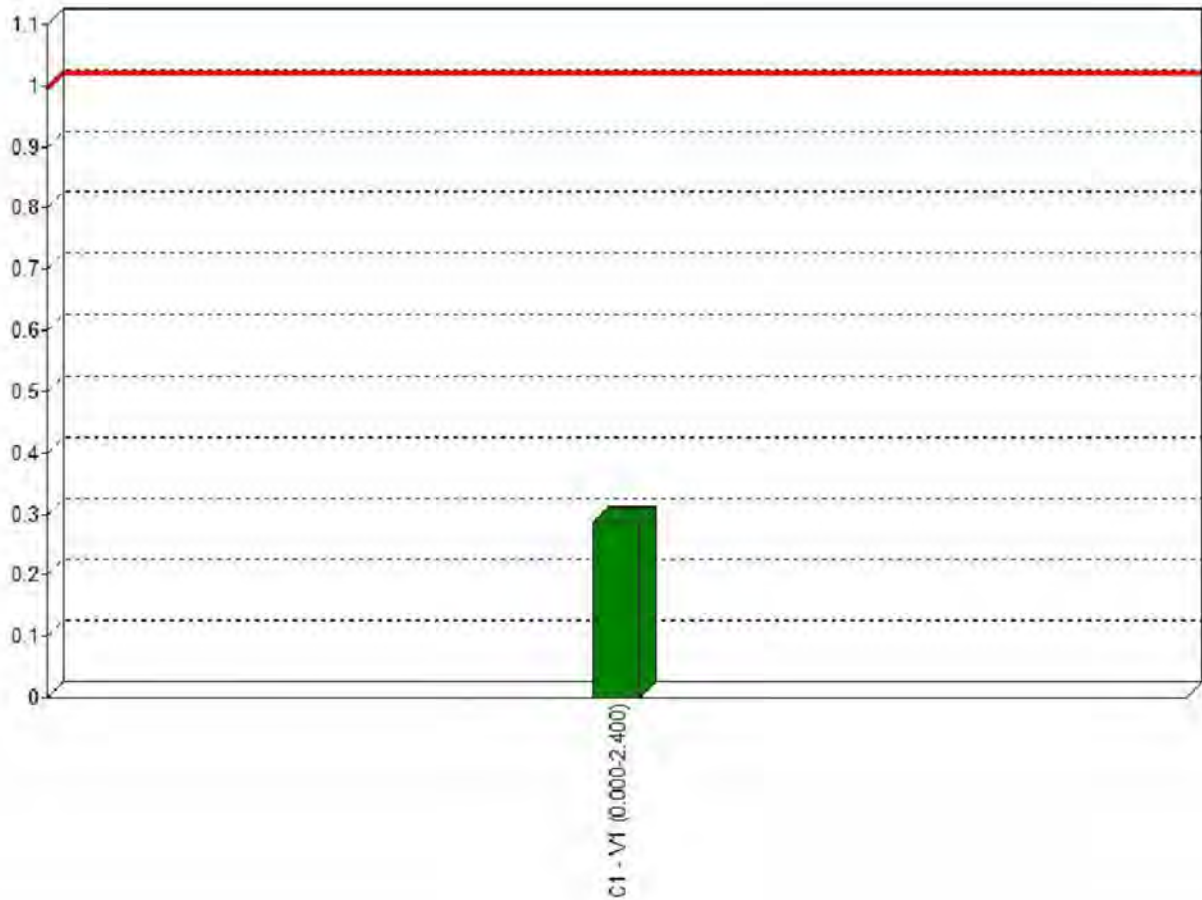

UNITY CHECK

Label	Toetsing	Combinatie	Artikel	UC max
C1	Doorsnede	Fu.C.1	NEN-EN1995-1-1#6.2.4 (6.19)	0.26
	Kip	Fu.C.1	NEN-EN1995-1-1#6.3.3 (6.35)	0.10
	Stabiliteit	Fu.C.1	NEN-EN1995-1-1#6.3.2 (6.23)	0.29

8.5 Bijlage uitraai MatrixFrame berekening Pos 5

AFB. GEOMETRIE RAAMWERK



STAVEN

Staf	Knoop B	Knoop E	X-B	Z-B	X-E	Z-E	Lengte	Profiel
S1	K1	K2	0.000	0.000	1.100	-2.500	2.731	P1
0.000 - L(2.731)								
-	-	-	m	m	m	m	m	-

PROFIELEN

Profiel	Profielnaam	Oppervlakte	Iy Materiaal	5.1.2.e
P1	R70x145	1.0150e-02	1.7784e-05 C24	0.0
-	-	m ²	m ⁴	°

PROFIELVORMEN

Profiel	Verl. h.	hB	hE	tf	tw	tf2	B	bL	bR	Raatl.
P1	Nee	0,145	0,145	0,0000	0,0000	0,0000	0,070	0,000	0,000	Nee 0,000
-	-	m	m	m	m	m	m	m	m	m

MATERIALEN

Materiaal	Dichtheid	E-Modulus	Uitzettingcoeff
C24	4.20	1.1000e+07	50.0000e-07
-	kN/m ³	kN/m ²	C°m

OPLEGGINGEN

Oplegging	Object	Positie	Z	Yr	HoekYr
O1	K1	0.000	vast	vast	vrij 0
O2	K2	0.000	vast	0.00:0.00	vrij 0
-	-	m	kN/m	kN/m	kNm/rad °

BELASTINGSGEVALLEN TYPEN

Oplegg.	Staven	5.1.2.e	Gunstig/Ong. Element	5.1.2.e	Psi0	Psi1	Cprob
Psi2	UGT/GGT						
B.G.1	Permanent	Permanent	-	N.v.t.	N.v.t.		
B.G.2	Verdeelde veranderlijke belasting	Verdeelde	-	Cat. H) Ontoegankelijke daken	1	1	
B.G.3	Geconcentreerde veranderlijke belasting	Geconcentreerde	-	Cat. H) Ontoegankelijke daken	N.v.t.	N.v.t.	
B.G.4	Windbelasting	Windbelasting	-	N.v.t.	N.v.t.	0.20	
B.G.5	Kniklengte (Assymetrisch)	Kniklengte		N.v.t.	N.v.t.		

B.G.6 Kniklengte (Symmetrisch) Kniklengte

N.v.t. N.v.t.

FUNDAMENTEEL BELASTINGSCOMBINATIES (TABEL)

B.G.	Omschrijving	Fu.C.1	Fu.C.2	Fu.C.3	Fu.C.4
B.G.1	Permanent	1,20	1,20	1,20	1,35
B.G.2	Verdeelde veranderlijke belasting	1,50	-	-	-
B.G.3	Geconcentreerde veranderlijke belasting	-	-	1,50	-
B.G.4	Windbelasting	-	1,50	-	-
B.G.5	Kniklengte (Assymetrisch)	-	-	-	-
B.G.6	Kniklengte (Symmetrisch)	-	-	-	-

KARAKTERISTIEK BELASTINGSCOMBINATIES (TABEL)

B.G.	Omschrijving	Ka.C.(w1)	Ka.C.1	Ka.C.2	Ka.C.3
B.G.1	Permanent	1,00	1,00	1,00	1,00
B.G.2	Verdeelde veranderlijke belasting	-	-	1,00	-
B.G.3	Geconcentreerde veranderlijke belasting	-	-	-	-
B.G.4	Windbelasting	-	-	-	1,00
B.G.5	Kniklengte (Assymetrisch)	-	-	-	-
B.G.6	Kniklengte (Symmetrisch)	-	-	-	-

FREQUENT BELASTINGSCOMBINATIES (TABEL)

B.G.	Omschrijving	Fr.C.(w1)	Fr.C.1	Fr.C.2
B.G.1	Permanent	1,00	1,00	1,00
B.G.2	Verdeelde veranderlijke belasting	-	-	-
B.G.3	Geconcentreerde veranderlijke belasting	-	-	-
B.G.4	Windbelasting	-	-	0,20
B.G.5	Kniklengte (Assymetrisch)	-	-	-
B.G.6	Kniklengte (Symmetrisch)	-	-	-

QUASI-PERMANENT BELASTINGSCOMBINATIES (TABEL)

B.G.	Omschrijving	Qu.C.1
B.G.1	Permanent	1,00
B.G.2	Verdeelde veranderlijke belasting	-
B.G.3	Geconcentreerde veranderlijke belasting	-
B.G.4	Windbelasting	-
B.G.5	Kniklengte (Assymetrisch)	-
B.G.6	Kniklengte (Symmetrisch)	-

UITGANGSPUNTEN VAN DE ANALYSE

Lineaire Elastische Analyse uitgevoerd

AFB. HOUTCONTROLE



SAMENSTELLING CONSTRUCTIEDELEN

Constructiedeel	StAAF/staven
C1	S1

STABILITEITSGEGEVENS

StAAF	Profiel	Y-As (assenstelsel)			Z-As(assenstelsel)	
		Lsys Methode Lkip/Lsys	Lkip	Lkip/Lsys	Methode	Lkip
C1 - V1 (0.000-2.731) 0.10	P1	2.731 Geschoord	2.629	0.96	Handmatige Invoer	0.273
-	-	m -	m	-	-	m -

KIPSTEUNENGEGEVENS

StAAF last	Profiel	Begin	Eind	Kipsteunen boven	Kipsteunen onder	Aangrijppunt
C1 - V1 (0.000-2.731)	P1	inklemming Volledig vast	inklemming Volledig vast	m	m	Neutraal
-	-	-	-	m	m	-

DOORBUIGINGGEGEVENS

StAAF w;2+w;3	Constr.type	Toetsingstype	Zeeg Y'	Zeeg Z'	Zeegvorm	w;max
C1 - V1 (0.000-2.731)	Dak	N.v.t.	0	0	Parabolisch	N/B
-	-	-	mm	mm	-	-

AFB. HOUT UC DIAGRAM

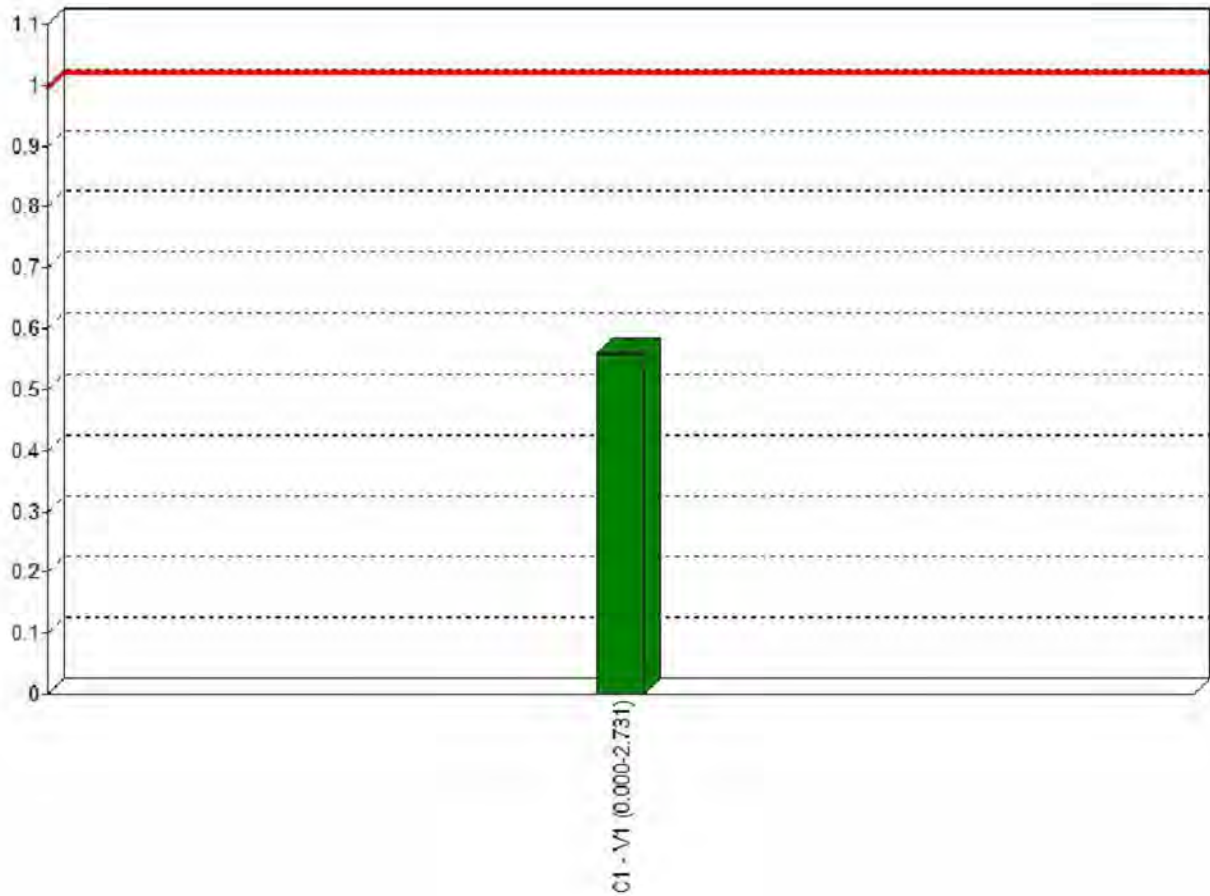

UNITY CHECK

Label	Toetsing	Combinatie	Artikel	UC max
C1	Doorsnede	Fu.C.2	NEN-EN1995-1-1#6.2.4 (6.19)	0.50
	Kip	Fu.C.2	NEN-EN1995-1-1#6.3.3 (6.35)	0.29
	Stabiliteit	Fu.C.2	NEN-EN1995-1-1#6.3.2 (6.23)	0.56

8.6 Bijlage uitraai MatrixFrame berekening Pos 6

AFB. GEOMETRIE LIGGER

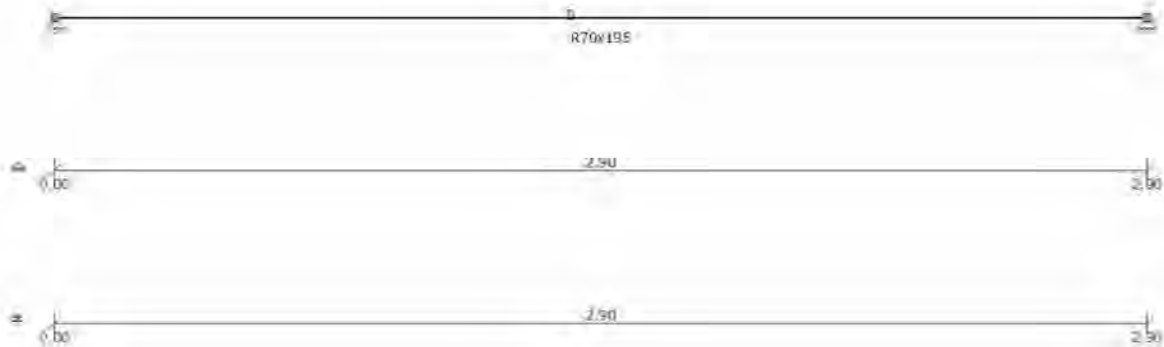

BALKGEOMETRIE

Positie	Profielnaam	5.1.2.e	Traagheidsmoment	Materiaal	E-Modulus	Uitzettingcoeff
0.000 - L(2.900)	R70x195	0	4.3253e-05	C24	1.1000e+07	50.0000e-07
0.06	m -	°	m4 -		kN/m2	C°m
	kN/m					

PROFIELVORMEN

Profiel	Verl. h.	hB	hE	tf	tw	tf2	B	bL	bR	Raatl.
Hoogte	Nee	0,195	0,195	0,0000	0,0000	0,0000	0,070	0,000	0,000	Nee
	-	m	m	m	m	m	m	m	m	m - m

MATERIALEN

Materiaalnaam	Poison	Dichtheid	E-Modulus	Uitzettingcoeff
C24	0.40	4.20	1.1000e+07	50.0000e-07
-	-	kN/m3	kN/m2	C°m

OPLEGGINGEN

Oplegging	Positie	Z	Yr
O1	0.000	vast	vrij
O2	L(2.900)	vast	vrij
-	m	kN/m	kNm/rad

BELASTINGSGEVALLEN TYPEN

Oplegg.	Staven	5.1.2.e	Gunstig/Ong. Element	5.1.2.e	Psi0	Psi1	Cprob
Psi2	UGT/GGT						
B.G.1	Permanent	Permanent	-	N.v.t.	N.v.t.		
B.G.2	Verdeelde veranderlijke	Verdeelde	-	Cat. A) Vloeren	1	1	0.40 0.50
0.30	1.00/1.00	veranderlijke					
	belasting	belasting					
B.G.3	Geconcentreerde	Geconcentreerde	-	Cat. A) Vloeren	N.v.t.	N.v.t.	0.40 0.50
0.30	veranderlijke belasting	veranderlijke					
		belasting					
B.G.2.1	Verdeelde veranderlijke	Verdeelde	-	Cat. A) Vloeren	1	1	0.40 0.50
0.30	1.00/1.00	veranderlijke					
	belasting	belasting					

AFB. LASTEN B.G.1 PERMANENT



AFB. LASTEN B.G.2 VERDEELDE VERANDERLIJKE BELASTING

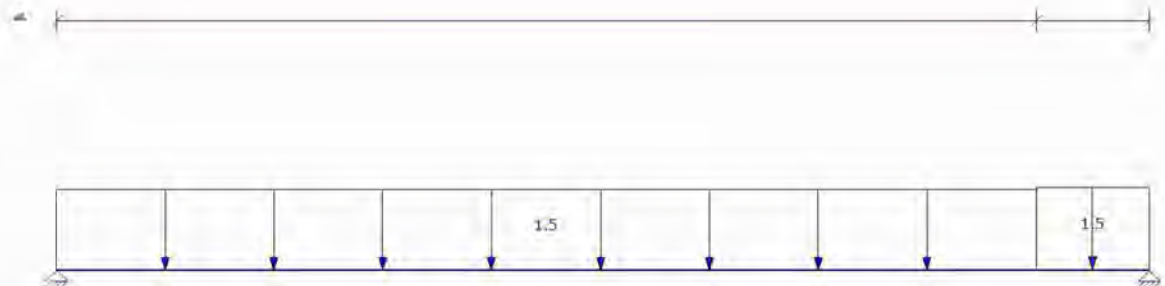

AFB. LASTEN B.G.3 GECONCENTREERDE VERANDERLIJKE BELASTING

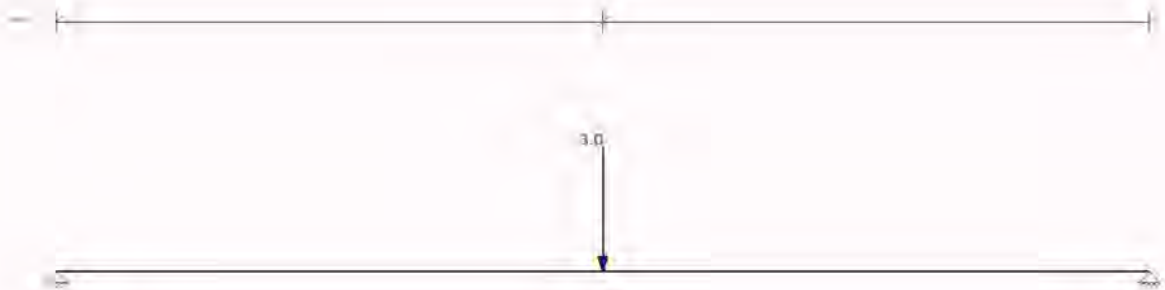

AFB. LASTEN B.G.2.1 VERDEELDE VERANDERLIJKE BELASTING

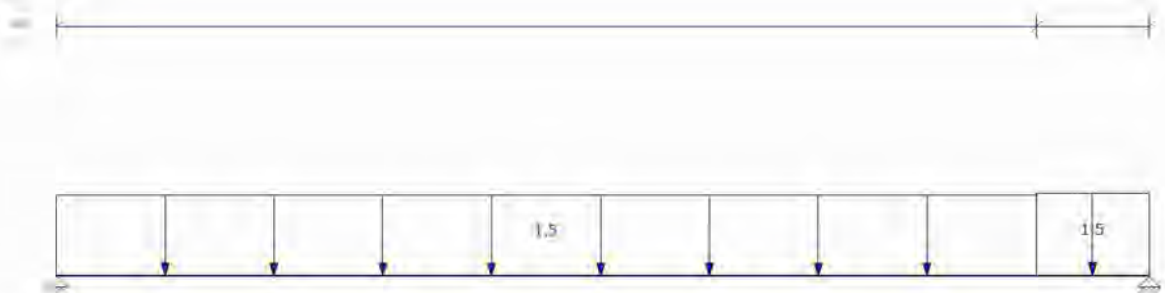

FUNDAMENTEEL BELASTINGSCOMBINATIES (TABEL)

B.G.	Omschrijving	Fu.C.1	Fu.C.2	Fu.C.3	Fu.C.4
B.G.1	Permanent	1.20	1.20	1.35	1.35
B.G.2	Verdeelde veranderlijke belasting	-	-	-	-
B.G.3	Geconcentreerde veranderlijke belasting	-	1.50	-	0.60
B.G.2.1	Verdeelde veranderlijke belasting	1.50	-	0.60	-

KARAKTERISTIEK BELASTINGSCOMBINATIES (TABEL)

B.G.	Omschrijving	Ka.C.(w1)	Ka.C.1	Ka.C.2
B.G.1	Permanent	1.00	1.00	1.00
B.G.2	Verdeelde veranderlijke belasting	-	-	-
B.G.3	Geconcentreerde veranderlijke belasting	-	-	-
B.G.2.1	Verdeelde veranderlijke belasting	-	0.40	1.00

FREQUENT BELASTINGSCOMBINATIES (TABEL)

B.G.	Omschrijving	Fr.C.(w1)	Fr.C.1
B.G.1	Permanent	1.00	1.00
B.G.2	Verdeelde veranderlijke belasting	-	-
B.G.3	Geconcentreerde veranderlijke belasting	-	-
B.G.2.1	Verdeelde veranderlijke belasting	-	0.50

QUASI-PERMANENT BELASTINGSCOMBINATIES (TABEL)

B.G.	Omschrijving	Qu.C.1
B.G.1	Permanent	1,00
B.G.2	Verdeelde veranderlijke belasting	-
B.G.3	Geconcentreerde veranderlijke belasting	-
B.G.2.1	Verdeelde veranderlijke belasting	0,30

UITGANGSPUNTEN VAN DE ANALYSE

Lineaire Elastische Analyse uitgevoerd

AFB. FU.C. MOMENT (MY) OMHULLENDE

Fundamenteel Belastingscombinaties

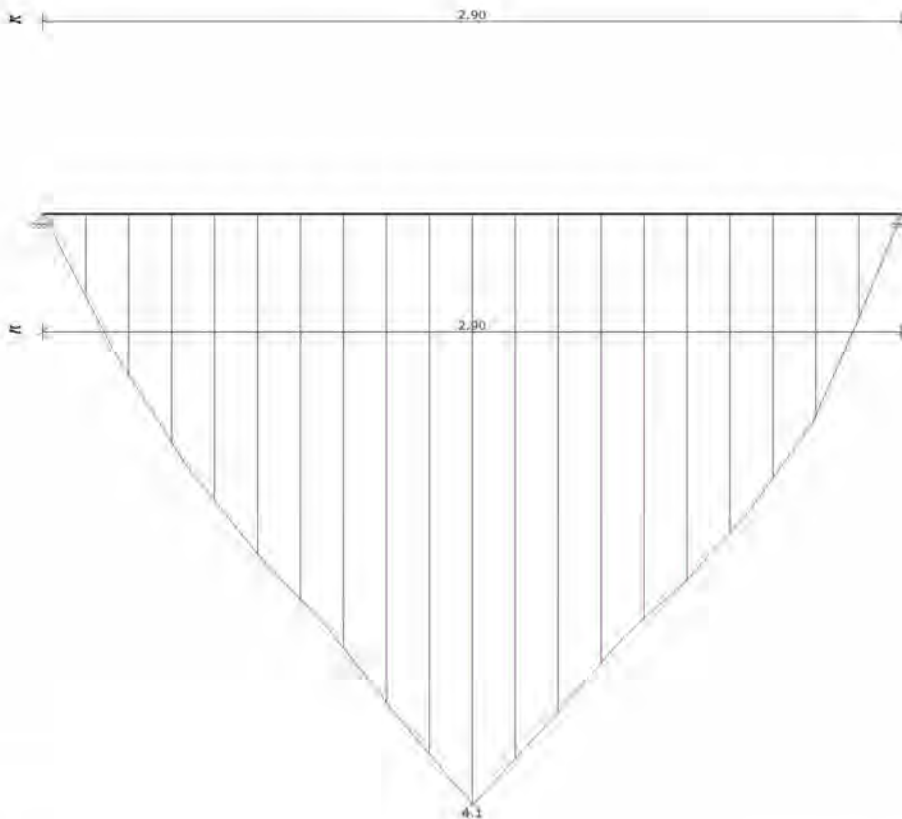

AFB. FU.C. DWARSKRACHT (VZ) OMHULLENDE

Fundamenteel Belastingscombinaties

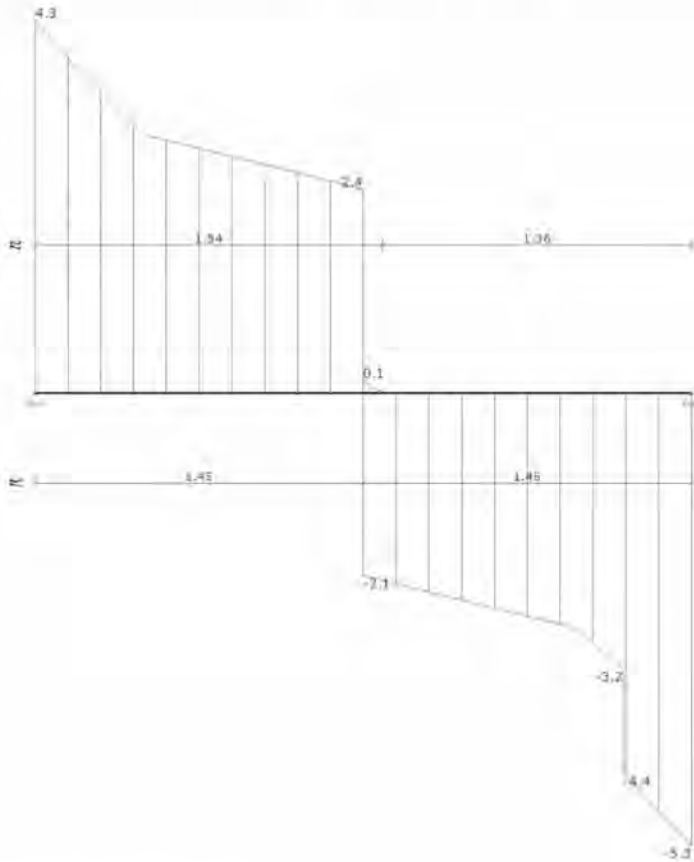

FU.C. STAAFKRACHTEN

Veld	Positie B.G.	Mb	Mmax	xMmax	Me	x-M0	x-M0	Vb
Vmax	Ve							
Veld 1	0.000 - 2.900 Fu.C.1	0.00	3.23	1.493	0.00	0.000	0.000	4.33
-5.26	-5.26							
	0.000 - 2.900 Fu.C.2	0.00	4.12	1.450	0.00	0.000	0.000	3.31
	-4.24 -4.24							
	0.000 - 2.900 Fu.C.3	0.00	1.92	1.535	0.00	0.000	0.000	2.50
	-3.54 -3.54							
	0.000 - 2.900 Fu.C.4	0.00	2.27	1.450	0.00	0.000	0.000	2.10
	-3.13 -3.13							
-	m -	kNm	kNm	m	kNm	m	m	kN
kN	kN							

AFB. FU.C. OPLEGREACTIES OMHULLENDE

Fundamenteel Belastingscombinaties



FU.C. OPLEGREACTIES

B.C.	Oplegging	Positie	Z	Yr	Z	My
Fu.C.1	O1	0.000	vast	vrij	-4.33	0.00
Fu.C.1	O2	2.900	vast	vrij	-5.26	0.00
	Som Reacties				-9.59	
	Som Lasten				9.59	
Fu.C.2	O1	0.000	vast	vrij	-3.31	0.00
Fu.C.2	O2	2.900	vast	vrij	-4.24	0.00
	Som Reacties				-7.55	
	Som Lasten				7.55	
Fu.C.3	O1	0.000	vast	vrij	-2.50	0.00
Fu.C.3	O2	2.900	vast	vrij	-3.54	0.00
	Som Reacties				-6.04	
	Som Lasten				6.04	
Fu.C.4	O1	0.000	vast	vrij	-2.10	0.00
Fu.C.4	O2	2.900	vast	vrij	-3.13	0.00
	Som Reacties				-5.23	
	Som Lasten				5.23	
-	-	m	kN/m	kNm/rad	kN	kNm

B.G. OPLEGREACTIES

B.C.	Oplegging	Positie	Z	Yr	Z	My
B.G.1	O1	0.000	vast	vrij	-0.89	0.00
B.G.1	O2	2.900	vast	vrij	-1.65	0.00
	Som Reacties				-2.54	
	Som Lasten				2.54	
B.G.2.1	O1	0.000	vast	vrij	-2.18	0.00
B.G.2.1	O2	2.900	vast	vrij	-2.18	0.00
	Som Reacties				-4.36	
	Som Lasten				4.36	
B.G.3	O1	0.000	vast	vrij	-1.50	0.00
B.G.3	O2	2.900	vast	vrij	-1.50	0.00
	Som Reacties				-3.00	
	Som Lasten				3.00	
-	-	m	kN/m	kNm/rad	kN	kNm

AFB. KA.C. VERPLAATSINGEN OMHULLENDE

Karakteristiek Belastingscombinaties

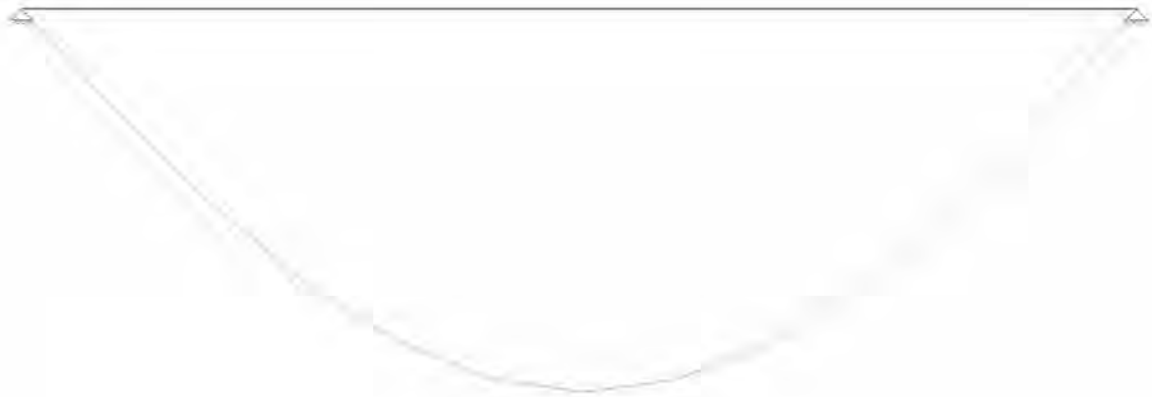

KA.C. KNOOPVERPLAATSINGEN

Knoop	B.C.	Z	Yr
K1	Ka.C.(w1)	0.0000	-1.452e-03
	Ka.C.1	0.0000	-2.734e-03
	Ka.C.2	0.0000	-4.658e-03
K2	Ka.C.(w1)	0.0000	1.667e-03
	Ka.C.1	0.0000	2.949e-03
	Ka.C.2	0.0000	4.873e-03
-	-	m	rad

KA.C. DOORBUIGINGEN

Veld	Positie B.C.	Veld Begin	Z'afst	Veld		Veld Eind	
				Z'	Z' glb dist	Z' glb	
S1	0.000 - 2.900 Ka.C.(w1)	0,0000	1.498	0,0014	1.498	0.0014	0,0000
S1	0.000 - 2.900 Ka.C.1	0,0000	1.476	0,0025	1.476	0.0025	0,0000
S1	0.000 - 2.900 Ka.C.2	0,0000	1.465	0,0043	1.465	0.0043	0,0000
-	m -	m	m	m	m	m	m

AFB. HOUTCONTROLE



SAMENSTELLING CONSTRUCTIEDELEN

Constructiedeel	Staaft/staven
C1	S1

STABILITEITSGEGEVENS

Staaft	Profiel	Y-As (assenstelsel)			Z-As(assenstelsel)	
		Lsys Methode	Lkip	Lkip/Lsys	Methode	Lkip
C1 - V1 (0.000-2.900)	P3	2.900 Conservatief	2.900	1.00	Conservatief	2.900
1.00		geschoord			geschoord	

- - m - m - - - m -

KIPSTEUNENGEGEVENS

Staaflast	Profiel	Begin	Eind	Kipsteunen boven	Kipsteunen onder	Aangrijppunt
C1 - V1 (0.000-2.900)	P3	inklemming	inklemming			Neutraal
-	-	Volledig vast	Volledig vast	m	m	-

DOORBUIGINGGEGEVENS

Staaflast w;2+w;3	Constr.type	Toetsingstype	Zeeg Y'	Zeeg Z'	Zeegvorm	w;max
C1 - V1 (0.000-2.900) L/333	Vloer	Algemeen	0	0	Parabolisch	L/250
-	-	-	mm	mm	-	-

UNITY CHECK

Label	Toetsing	Combinatie	Artikel	UC max
C1	Doorsnede	Fu.C.2	NEN-EN1995-1-1#6.1.6 (6.11)	0.63
	Kip	Fu.C.2	NEN-EN1995-1-1#6.3.3 (6.33)	0.63
	Doorbuiging	Ka.C.2	NEN-EN1995#7.2 NEN-EN1990#A1.4.3(4)	0.49

8.7 Bijlage uitraai MatrixFrame berekening Pos 7

AFB. GEOMETRIE LIGGER

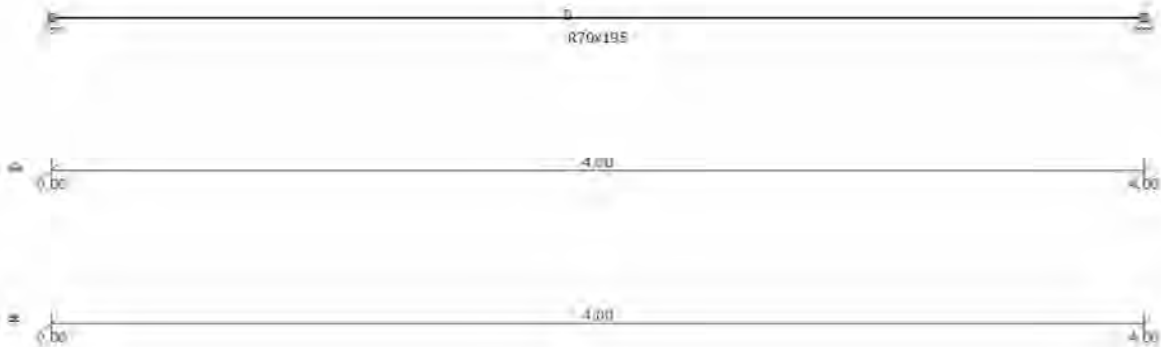

BALKGEOMETRIE

Positie	Profielnaam	5.1.2.e	Traagheidsmoment	Materiaal	E-Modulus	Uitzettingcoeff
0.000 - L(4.000)	R70x195	0	4.3253e-05	C24	1.1000e+07	50.0000e-07
0.06	m -	°	m4 -	kN/m2	C°m	
	kN/m					

PROFIELVORMEN

Profiel	Verl. h.	hB	hE	tf	tw	tf2	B	bL	bR	Raatl.
P3	Nee	0,195	0,195	0,0000	0,0000	0,0000	0,070	0,000	0,000	Nee
-	-	m	m	m	m	m	m	m	m	m - m

MATERIALEN

Materiaalnaam	Poison	Dichtheid	E-Modulus	Uitzettingcoeff
C24	0.40	4.20	1.1000e+07	50.0000e-07
-	-	kN/m3	kN/m2	C°m

OPLEGGINGEN

Oplegging	Positie	Z	Yr
O1	0.000	vast	vrij
O2	L(4.000)	vast	vrij
-	m	kN/m	kNm/rad

BELASTINGSGEVALLEN TYPEN

Oplegg.	Staven	5.1.2.e	Gunstig/Ong. Element	5.1.2.e	Psi0	Psi1	Cprob
Psi2	UGT/GGT						
B.G.1	Permanent	Permanent	-	N.v.t.	N.v.t.		
B.G.2	Verdeelde veranderlijke	Verdeelde	-	Cat. A) Vloeren	1	1	0.40 0.50
0.30	1.00/1.00	veranderlijke					
	belasting	belasting					
B.G.3	Geconcentreerde	Geconcentreerde	-	Cat. A) Vloeren	N.v.t.	N.v.t.	0.40 0.50
0.30	veranderlijke belasting	veranderlijke					
	belasting	belasting					
B.G.2.1	Verdeelde veranderlijke	Verdeelde	-	Cat. A) Vloeren	1	1	0.40 0.50
0.30	1.00/1.00	veranderlijke					
	belasting	belasting					

AFB. LASTEN B.G.1 PERMANENT

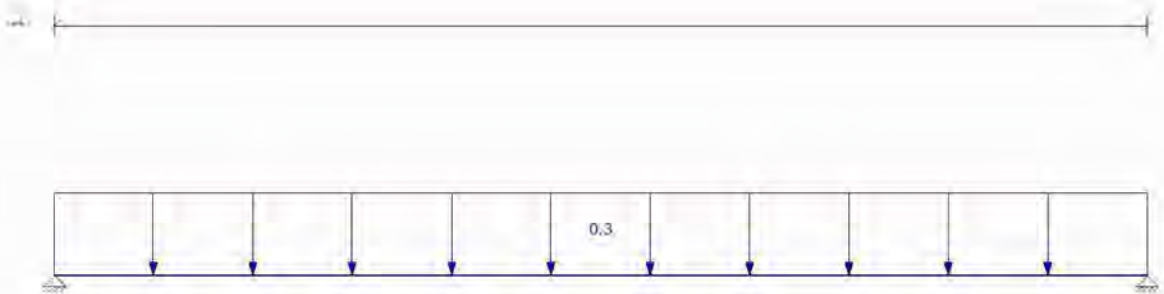

AFB. LASTEN B.G.2 VERDEELDE VERANDERLIJKE BELASTING

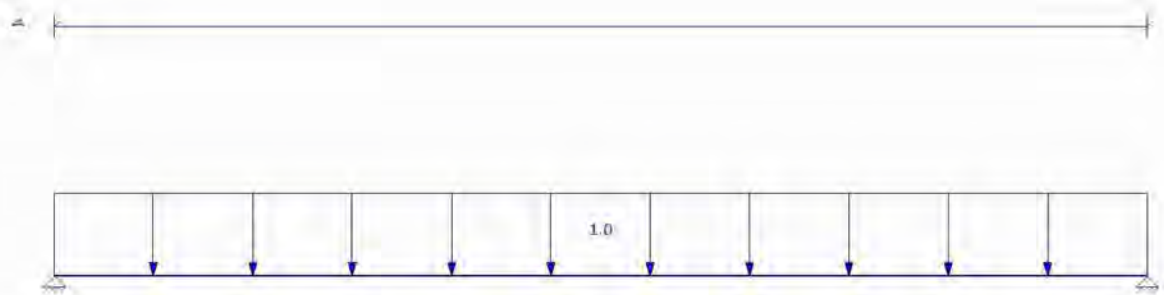

AFB. LASTEN B.G.3 GECONCENTREERDE VERANDERLIJKE BELASTING

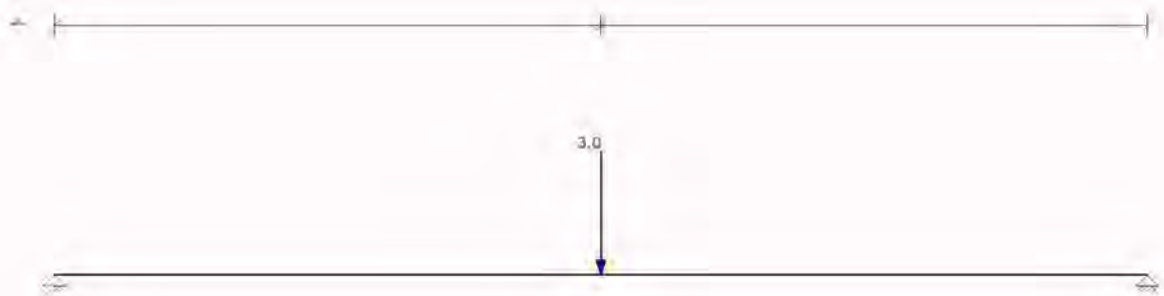

AFB. LASTEN B.G. 2.1 VERDEELDE VERANDERLIJKE BELASTING

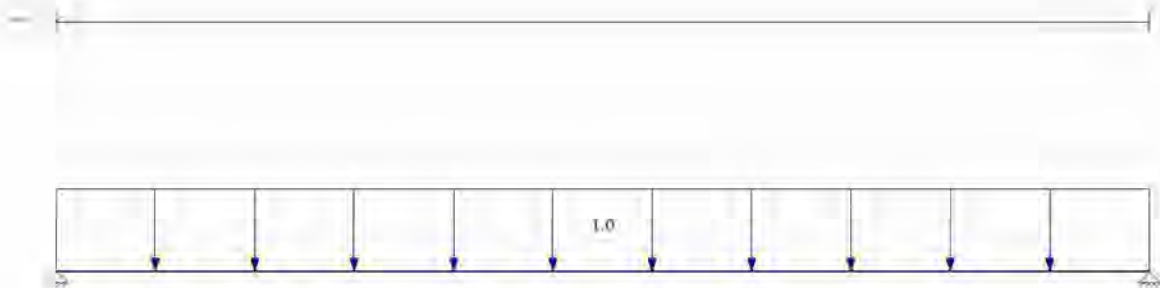

FUNDAMENTEEL BELASTINGSCOMBINATIES (TABEL)

B.G.	Omschrijving	Fu.C.1	Fu.C.2	Fu.C.3	Fu.C.4
B.G.1	Permanent	1.20	1.20	1.35	1.35
B.G.2	Verdeelde veranderlijke belasting	-	-	-	-
B.G.3	Geconcentreerde veranderlijke belasting	-	1.50	-	0.60
B.G.2.1	Verdeelde veranderlijke belasting	1.50	-	0.60	-

KARAKTERISTIEK BELASTINGSCOMBINATIES (TABEL)

B.G.	Omschrijving	Ka.C.(w1)	Ka.C.1	Ka.C.2
B.G.1	Permanent	1.00	1.00	1.00
B.G.2	Verdeelde veranderlijke belasting	-	-	-
B.G.3	Geconcentreerde veranderlijke belasting	-	-	-
B.G.2.1	Verdeelde veranderlijke belasting	-	0.40	1.00

FREQUENT BELASTINGSCOMBINATIES (TABEL)

B.G.	Omschrijving	Fr.C.(w1)	Fr.C.1
B.G.1	Permanent	1.00	1.00
B.G.2	Verdeelde veranderlijke belasting	-	-
B.G.3	Geconcentreerde veranderlijke belasting	-	-
B.G.2.1	Verdeelde veranderlijke belasting	-	0.50

QUASI-PERMANENT BELASTINGSCOMBINATIES (TABEL)

B.G.	Omschrijving	Qu.C.1
B.G.1	Permanent	1.00
B.G.2	Verdeelde veranderlijke belasting	-
B.G.3	Geconcentreerde veranderlijke belasting	-
B.G.2.1	Verdeelde veranderlijke belasting	0.30

UITGANGSPUNTEN VAN DE ANALYSE

Lineaire Elastische Analyse uitgevoerd

AFB. FU.C. MOMENT (MY) OMHULLENDE

Fundamenteel Belastingcombinaties

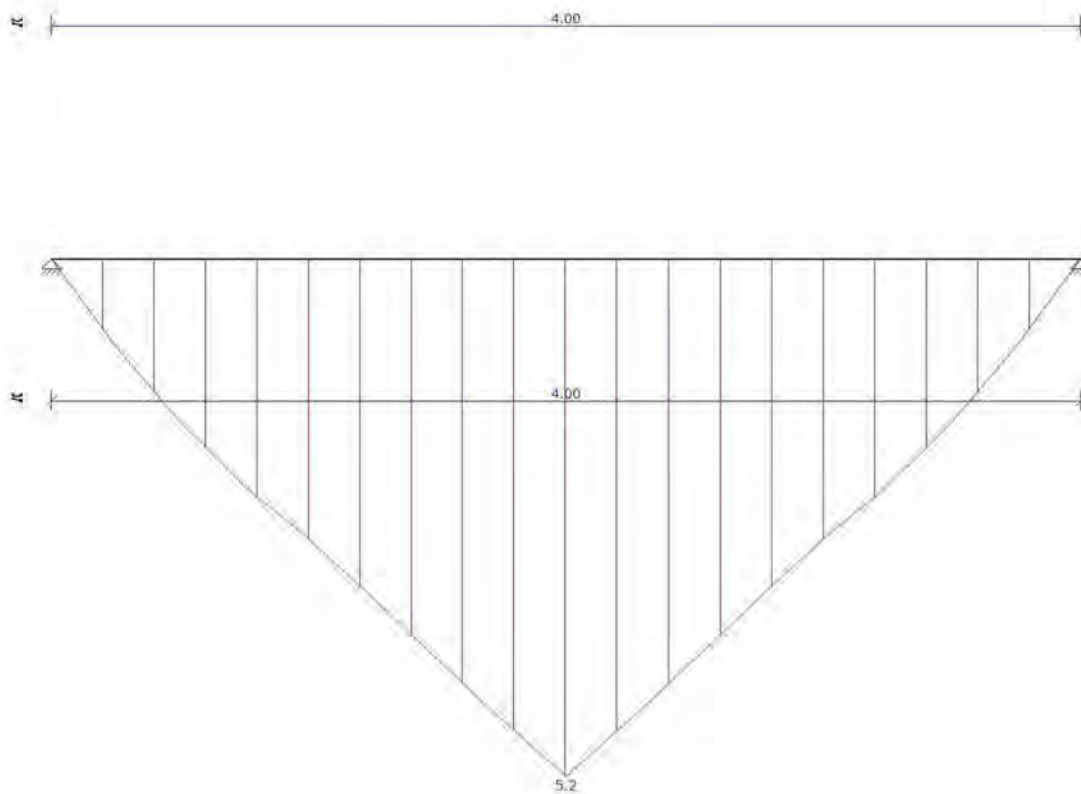

AFB. FU.C. DWARSKRACHT (VZ) OMHULLENDE

Fundamenteel Belastingscombinaties

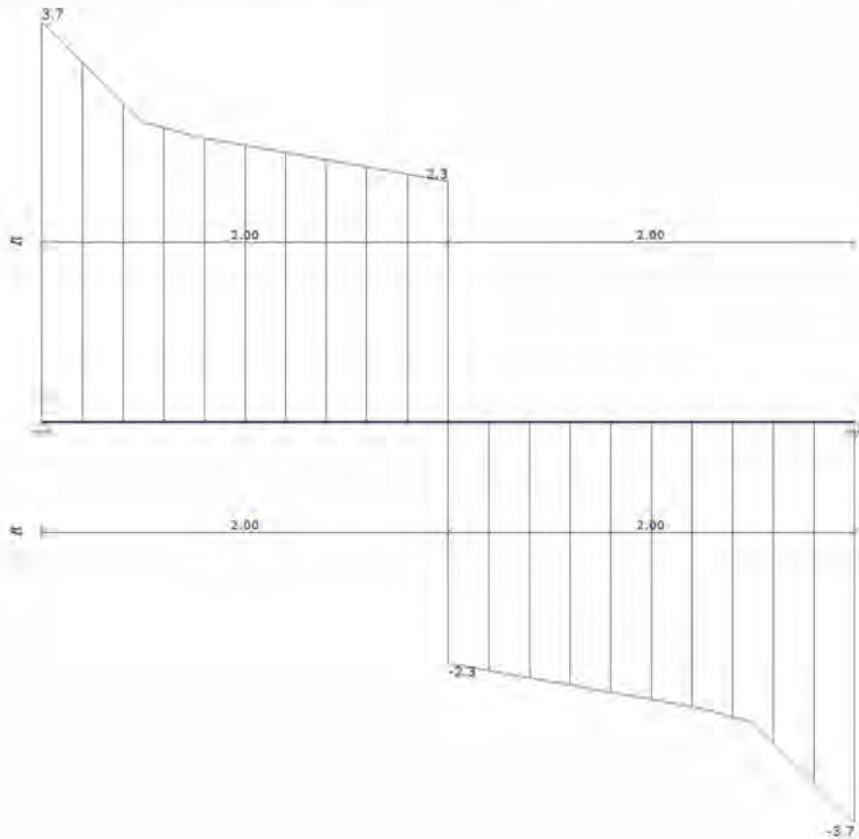

FU.C. STAAFKRACHTEN

Veld	Positie B.G. Ve	Mb	Mmax	xMmax	Me	x-M0	x-M0	Vb
Veld 1	0.000 - 4.000 Fu.C.1	0.00	3.73	2.000	0.00	0.000	0.000	3.73
	3.73 -3.73							
	0.000 - 4.000 Fu.C.2	0.00	5.17	2.000	0.00	0.000	0.000	2.92
	2.92 -2.92							
	0.000 - 4.000 Fu.C.3	0.00	1.98	2.000	0.00	0.000	0.000	1.98
	1.98 -1.98							
	0.000 - 4.000 Fu.C.4	0.00	2.56	2.000	0.00	0.000	0.000	1.66
	1.66 -1.66							
-	m -	kNm	kNm	m	kNm	m	m	kN
kN	kN							

AFB. FU.C. OPLEGREACTIES OMHULLENDE

Fundamenteel Belastingscombinaties



FU.C. OPLEGREACTIES

B.C.	Oplegging	Positie	Z	Yr	Z	My
Fu.C.1	O1	0.000	vast	vrij	-3.73	0.00
Fu.C.1	O2	4.000	vast	vrij	-3.73	0.00
	Som Reacties				-7.47	
	Som Lasten				7.47	
Fu.C.2	O1	0.000	vast	vrij	-2.92	0.00
Fu.C.2	O2	4.000	vast	vrij	-2.92	0.00
	Som Reacties				-5.85	
	Som Lasten				5.85	
Fu.C.3	O1	0.000	vast	vrij	-1.98	0.00
Fu.C.3	O2	4.000	vast	vrij	-1.98	0.00
	Som Reacties				-3.96	
	Som Lasten				3.96	
Fu.C.4	O1	0.000	vast	vrij	-1.66	0.00
Fu.C.4	O2	4.000	vast	vrij	-1.66	0.00
	Som Reacties				-3.31	
	Som Lasten				3.31	
-	-	m	kN/m	kNm/rad	kN	kNm

B.G. OPLEGREACTIES

B.C.	Oplegging	Positie	Z	Yr	Z	My
B.G.1	O1	0.000	vast	vrij	-0.56	0.00
B.G.1	O2	4.000	vast	vrij	-0.56	0.00
	Som Reacties				-1.12	
	Som Lasten				1.12	
B.G.2.1	O1	0.000	vast	vrij	-2.04	0.00
B.G.2.1	O2	4.000	vast	vrij	-2.04	0.00
	Som Reacties				-4.08	
	Som Lasten				4.08	
B.G.3	O1	0.000	vast	vrij	-1.50	0.00
B.G.3	O2	4.000	vast	vrij	-1.50	0.00
	Som Reacties				-3.00	
	Som Lasten				3.00	
-	-	m	kN/m	kNm/rad	kN	kNm

AFB. KA.C. VERPLAATSINGEN OMHULLENDE

Karakteristiek Belastingscombinaties



KA.C. KNOOPVERPLAATSINGEN

Knoop	B.C.	Z	Yr
K1	Ka.C.(w1)	0.0000	-1.569e-03
	Ka.C.1	0.0000	-3.856e-03
	Ka.C.2	0.0000	-7.286e-03
K2	Ka.C.(w1)	0.0000	1.569e-03
Knoop	B.C.	Z	Yr
K2	Ka.C.1	0.0000	3.856e-03
	Ka.C.2	0.0000	7.286e-03
-	-	m	rad

KA.C. DOORBUIGINGEN

Veld	Positie B.C.	Veld Begin	Z'afst	Veld Z'	Z' glb dist	Veld Eind Z' glb
S1	0.000 - 4.000 Ka.C.(w1)	0,0000	2.000	0,0020	2.000	0.0020 0,0000
S1	0.000 - 4.000 Ka.C.1	0,0000	2.000	0,0048	2.000	0.0048 0,0000
S1	0.000 - 4.000 Ka.C.2	0,0000	2.000	0,0091	2.000	0.0091 0,0000
-	m -	m	m	m	m	m m

AFB. HOUTCONTROLE

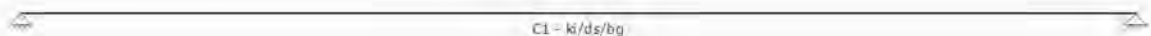

SAMENSTELLING CONSTRUCTIEDELEN

Constructiedeel	Staal/staven
C1	S1

STABILITEITSGEGEVENS

Staal	Profiel	Y-As (assenstelsel)			Z-As(assenstelsel)		
		Lsys Lkip/Lsys	Methode	Lkip	Lkip/Lsys	Methode	Lkip
C1 - V1 (0.000-4.000)	P3	4.000	Conservatief	4.000	1.00	Conservatief	4.000
1.00			geschoord			geschoord	
-	-	m -		m	-	-	m -

KIPSTEUNENGEGEVENS

Staf last	Profiel	Begin	Eind	Kipsteunen boven	Kipsteunen onder	Aangrijppunt
C1 - V1 (0.000-4.000)	P3	inklemming	inklemming			Neutraal
-	-	Volledig vast	Volledig vast	m	m	-

DOORBUIGINGGEGEVENS

Staf w;2+w;3	Constr.type	Toetsingstype	Zeeg Y'	Zeeg Z'	Zeegvorm	w;max
C1 - V1 (0.000-4.000) L/333	Vloer	Algemeen	0	0	Parabolisch	L/250
-	-	-	mm	mm	-	-

UNITY CHECK

Label	Toetsing	Combinatie	Artikel	UC max
C1	Doorsnede	Fu.C.2	NEN-EN1995-1-1#6.1.6 (6.11)	0.79
	Kip	Fu.C.2	NEN-EN1995-1-1#6.3.3 (6.33)	0.79
	Doorbuiging	Ka.C.2	NEN-EN1995#7.2 NEN-EN1990#A1.4.3(4)	0.80

8.8 Bijlage uitraai MatrixFrame berekening Pos 8

AFB. GEOMETRIE LIGGER

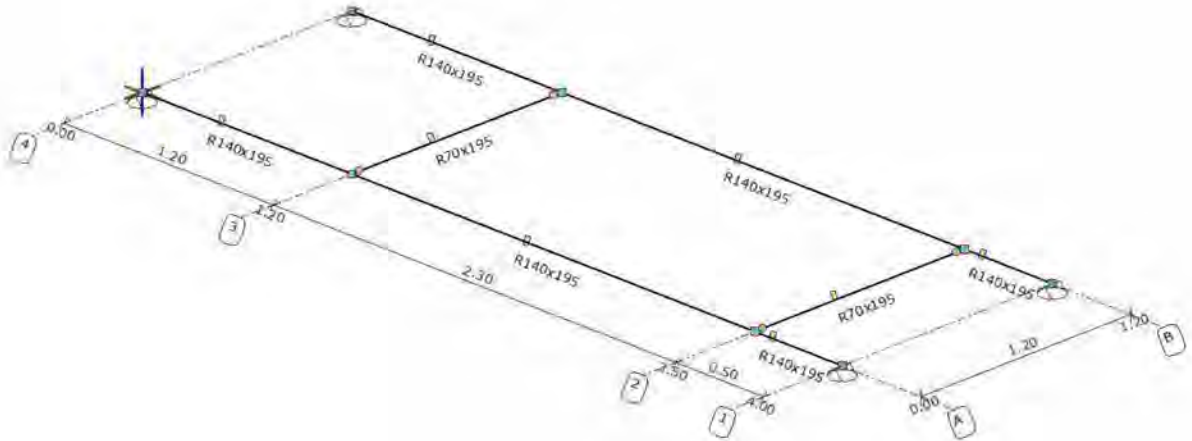

STAVEN

Staf	Knoop B	Knoop E	X-B	Y-B	Z-B	X-E	Y-E	Z-E	Lengte	Profiel
S1	K2	K6	0,000	1,200	0,000	1,200	1,200	0,000	1,200	P1
0,000 - L(1,200)										
S2	K3	K7	0,000	3,500	0,000	1,200	3,500	0,000	1,200	P1
0,000 - L(1,200)										
S3	K1	K2	0,000	0,000	0,000	0,000	1,200	0,000	1,200	P2
0,000 - L(1,200)										
S4	K2	K3	0,000	1,200	0,000	0,000	3,500	0,000	2,300	P2
0,000 - L(2,300)										
S5	K3	K4	0,000	3,500	0,000	0,000	4,000	0,000	0,500	P2
0,000 - L(0,500)										
S6	K5	K6	1,200	0,000	0,000	1,200	1,200	0,000	1,200	P2
0,000 - L(1,200)										
S7	K6	K7	1,200	1,200	0,000	1,200	3,500	0,000	2,300	P2
0,000 - L(2,300)										
S8	K7	K8	1,200	3,500	0,000	1,200	4,000	0,000	0,500	P2
0,000 - L(0,500)										
-	-	-	m	m	m	m	m	m	m	-

SCHARNIEREN

Staf	Positie		Oplegg.	Scharnier	Xr	Yr	Zr
	Staf	Positie					
S1		0,000 A1	Vast	Vast	Vast	Vrij	Vrij
		L(1,200) A1	Vast	Vast	Vast	Vrij	Vrij
S2		0,000 A1	Vast	Vast	Vast	Vrij	Vrij
		L(1,200) A1	Vast	Vast	Vast	Vrij	Vrij
-		m -	kN/m	kN/m	kN/m	kNm/rad	kNm/rad

PROFIELEN

Profiel	Profielnaam	Oppervlakte	It	Iy	Iz	Materiaal	5.1.2.e
P1	R70x195	1.3650e-02	1.7260e-05	4.3253e-05	5.5738e-06	C24	0,0

P2	R140x195	2.7300e-02	9.9473e-05	8.6507e-05	4.4590e-05	C24	0,0
-	-	m2	m4	m4	m4	-	↻

PROFIELVORMEN

Profiel	Verl. h.	hB	hE	tf	tw	tf2	B	bL	bR	Raatl.
P1	Nee	0,195	0,195	0,0000	0,0000	0,0000	0,070	0,000	0,000	Nee 0,000
P2	Nee	0,195	0,195	0,0000	0,0000	0,0000	0,140	0,000	0,000	Nee 0,000
-	-	m	m	m	m	m	m	m	m	- m

MATERIALEN

Materiaalnaam	Poison	Dichtheid	E-Modulus	Uitzettingcoeff
C24	0.40	4.20	1.1000e+07	50.0000e-07
-	-	kN/m3	kN/m2	C _{em}

OPLEGGINGEN

Oplegging	Object	Positie	Z	Xr	Yr	Zr	HoekXr	HoekYr	
O1	K1	0,000	Vast	Vast	Vast	Vrij	Vast	Vrij	0 0
O2	K4	0,000	Vast	Vast	Vast	Vrij	Vast	Vrij	0 0
O3	K5	0,000	Vast	Vast	Vast	Vrij	Vast	Vrij	0 0
O4	K8	0,000	Vast	Vast	Vast	Vrij	Vast	Vrij	0 0
-	-	m	kN/m	kN/m	kN/m	kNm/rad	kNm/rad	kNm/rad	↻ ↻ ↻

BELASTINGSGEVALLEN TYPEN

Oplegg.	Staven	5.1.2.e	Gunstig/Ong. Element	5.1.2.e	Psi0	Psi1	Cprob
Psi2	UGT/GGT						
B.G.1	Permanent	Permanent	-		N.v.t.	N.v.t.	
B.G.2	Verdeelde veranderlijke	Verdeelde	-	Cat. A) Vloeren	1	1	0.40 0.50
0.30	1,00/1,00	veranderlijke					
	belasting	belasting					
B.G.3	Geconcentreerde	Geconcentreerde	-	Cat. A) Vloeren	N.v.t.	N.v.t.	0.40 0.50
0.30	veranderlijke belasting	veranderlijke					
	belasting	belasting					

AFB. LASTEN B.G.1 PERMANENT

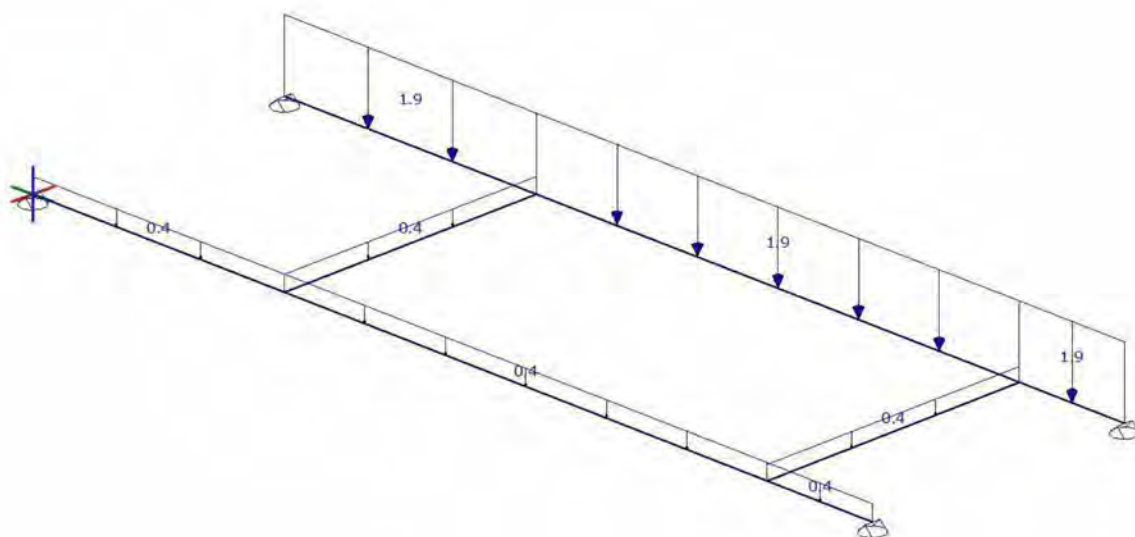

AFB. LASTEN B.G.2 VERDEELDE VERANDERLIJKE BELASTING

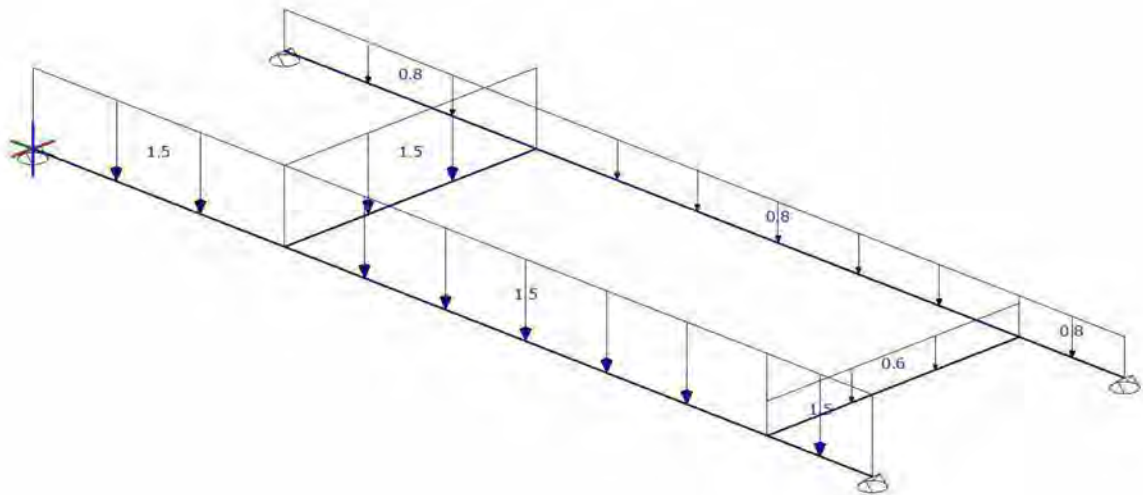

AFB. LASTEN B.G.3 GECONCENTREERDE VERANDERLIJKE BELASTING

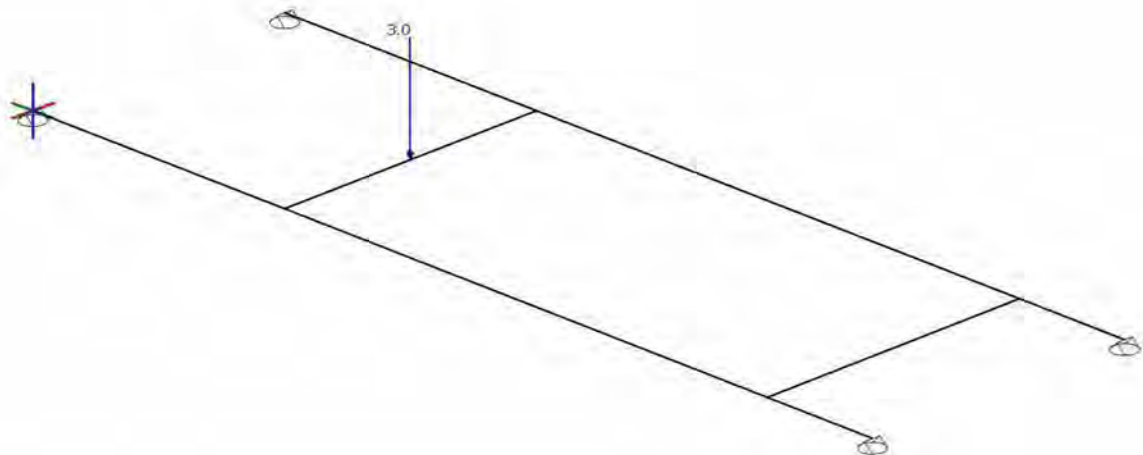

FUNDAMENTEEL BELASTINGSCOMBINATIES (TABEL)

B.G.	Omschrijving	Fu.C.1	Fu.C.2	Fu.C.3	Fu.C.4
B.G.1	Permanent	1.20	1.20	1.35	1.35
B.G.2	Verdeelde veranderlijke belasting	1.50	-	0.60	-
B.G.3	Geconcentreerde veranderlijke belasting	-	1.50	-	0.60

KARAKTERISTIEK BELASTINGSCOMBINATIES (TABEL)

B.G.	Omschrijving	Ka.C.(w1)		Ka.C.1	Ka.C.2
B.G.1	Permanent	1.00	1.00	1.00	
B.G.2	Verdeelde veranderlijke belasting	-	0.40	1.00	
B.G.3	Geconcentreerde veranderlijke belasting	-	-	-	

FREQUENT BELASTINGSCOMBINATIES (TABEL)

B.G.	Omschrijving	Fr.C.(w1)	Fr.C.1
B.G.1	Permanent	1.00	1.00
B.G.2	Verdeelde veranderlijke belasting	-	0.50
B.G.3	Geconcentreerde veranderlijke belasting	-	-

QUASI-PERMANENT BELASTINGSCOMBINATIES (TABEL)

B.G.	Omschrijving	Qu.C.1
B.G.1	Permanent	1.00
B.G.2	Verdeelde veranderlijke belasting	0.30
B.G.3	Geconcentreerde veranderlijke belasting	-

UITGANGSPUNTEN VAN DE ANALYSE

Lineaire Elastische Analyse uitgevoerd

AFB. FU.C. MOMENT (MY) OMHULLENDE

Fundamenteel Belastingscombinaties

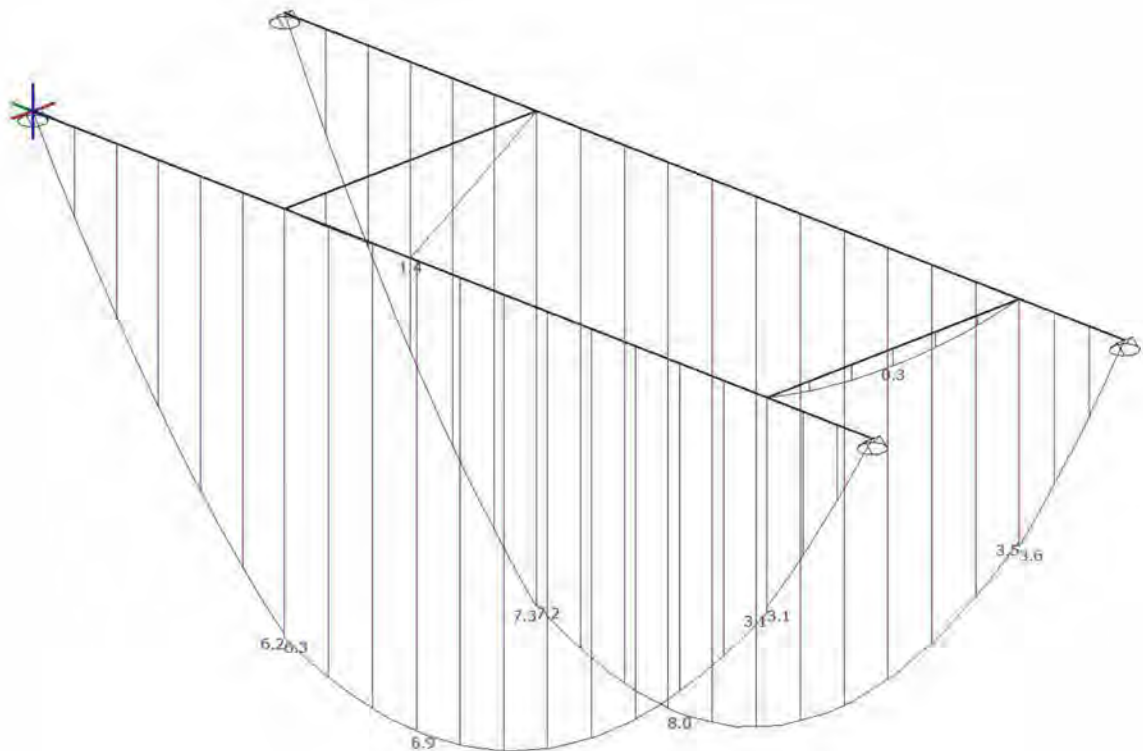

AFB. FU.C. DWARSKRACHT (VZ) OMHULLENDE

Fundamenteel Belastingscombinaties

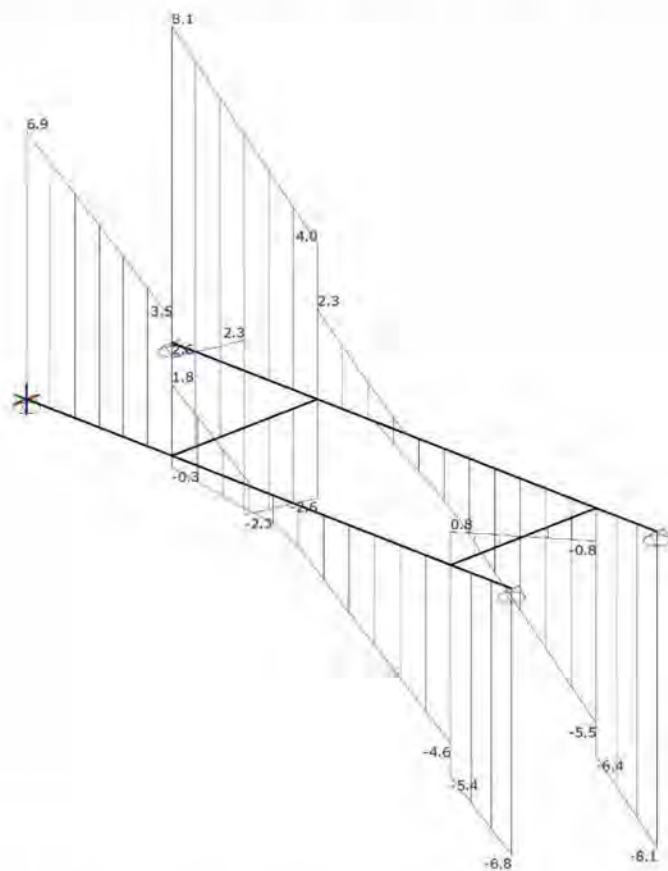

AFB. FU.C. OPLEGREACTIES OMHULLENDE

Fundamenteel Belastingscombinaties

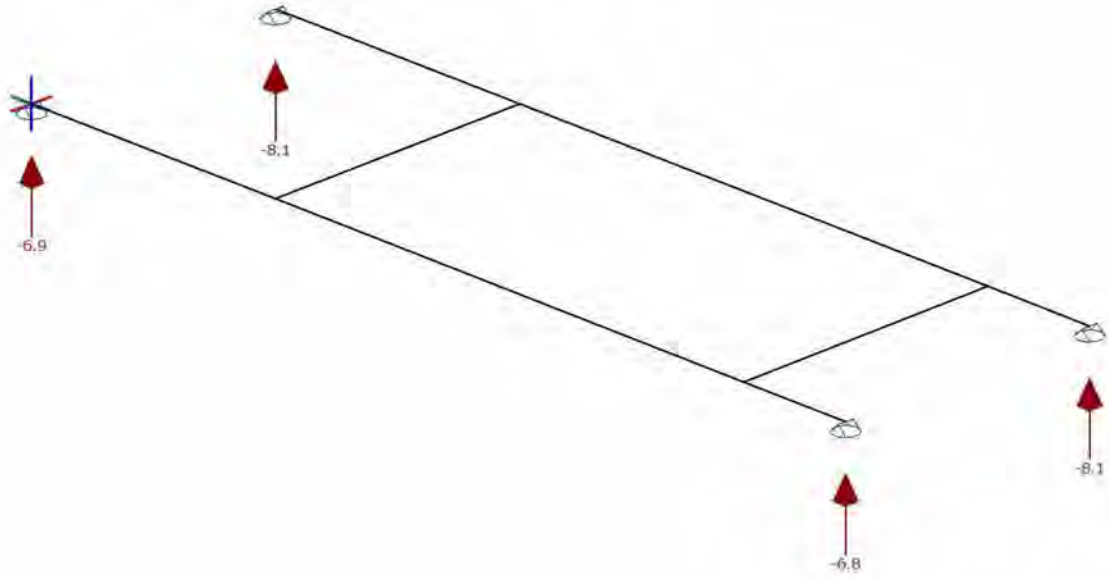

AFB. KA.C. VERPLAATSINGEN OMHULLENDE

Karakteristiek Belastingscombinaties

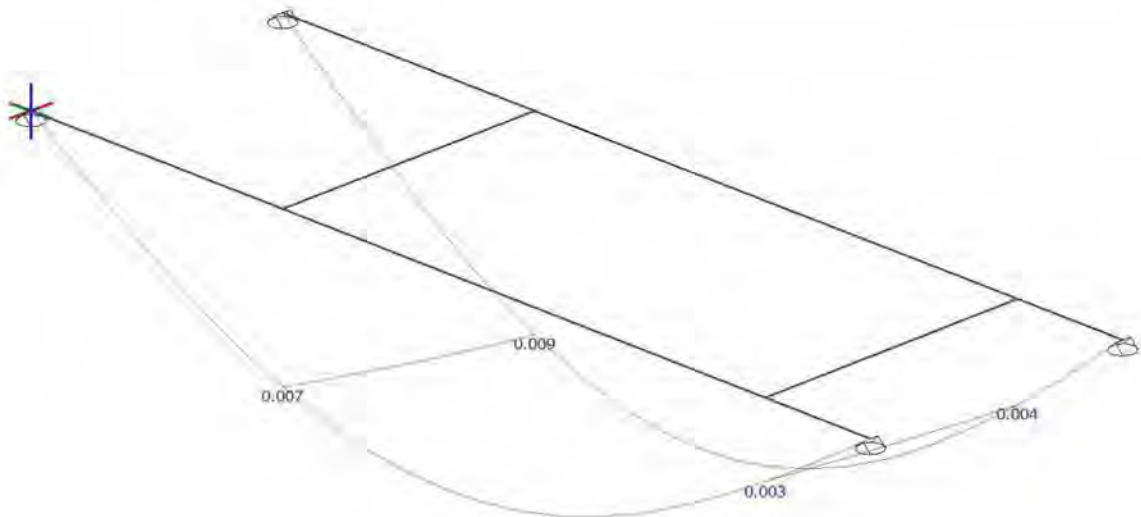

AFB. HOUTCONTROLE

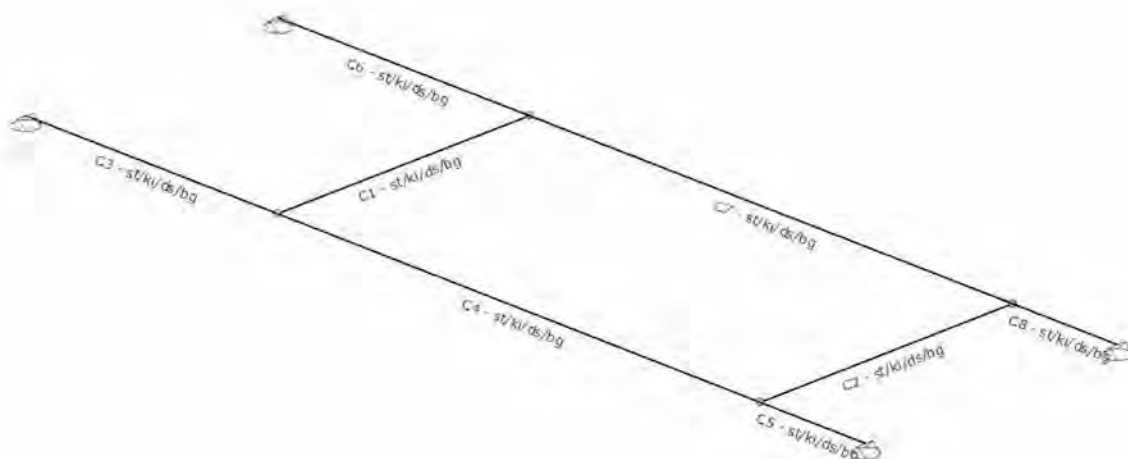

SAMENSTELLING CONSTRUCTIEDELEN

Constructiedeel	Staaf/staven
C1	S1
C2	S2
C3	S3
C4	S4
C5	S5
C6	S6
C7	S7
C8	S8

STABILITEITSGEGEVENS

Staaf	Profiel	Y-As (assenstelsel)			Z-As(assenstelsel)		
		Lsys Lkip/Lsys	Methode	Lkip	Lkip/Lsys	Methode	Lkip
C1 - V1 (0.000-1.200) 1.00	P1	1,200	Conservatief	1.200	1.00	Conservatief	1.200
C2 - V1 (0.000-1.200) 1.00	P1	1,200	Conservatief	1.200	1,00	Conservatief	1.200
C3 - V1 (0.000-1.200) 1.00	P2	1,200	Conservatief	1.200	1,00	Conservatief	1.200
C4 - V1 (0.000-2.300) 1.00	P2	2,300	Conservatief	2.300	1,00	Conservatief	2.300
C5 - V1 (0.000-0.500) 1.00	P2	0,500	Conservatief	0.500	1,00	Conservatief	0.500
C6 - V1 (0.000-1.200) 1.00	P2	1,200	Conservatief	1.200	1,00	Conservatief	1.200
C7 - V1 (0.000-2.300) 1.00	P2	2,300	Conservatief	2.300	1,00	Conservatief	2.300
C8 - V1 (0.000-0.500) 1.00	P2	0,500	Conservatief	0.500	1,00	Conservatief	0.500

		geschoord				geschoord	
		m		m		m	
KIPSTEUNENGEGEVENS							
Staaflast	Profiel	Begin	End	Kipsteunen boven	Kipsteunen onder	Aangrijppunt	
C1 - V1 (0.000-1.200)	P1	inkleming	inkleming	Volledig vast	Volledig vast	Neutraal	
Staaflast							
C2 - V1 (0.000-1.200)	P1	inkleming	inkleming	Volledig vast	Volledig vast	Neutraal	
C3 - V1 (0.000-1.200)	P2	Volledig vast	Volledig vast			Neutraal	
C4 - V1 (0.000-2.300)	P2	Volledig vast	Volledig vast			Neutraal	
C5 - V1 (0.000-0.500)	P2	Volledig vast	Volledig vast			Neutraal	
C6 - V1 (0.000-1.200)	P2	Volledig vast	Volledig vast			Neutraal	
C7 - V1 (0.000-2.300)	P2	Volledig vast	Volledig vast			Neutraal	
C8 - V1 (0.000-0.500)	P2	Volledig vast	Volledig vast			Neutraal	

DOORBUIGINGGEGEVENS

Staaflast	Constr.type	Toetsingstype	Zeeg Y'	Zeeg Z'	Zeegvorm	w;max
C1 - V1 (0.000-1.200)	Vloer L/333	Algemeen	0	0	Parabolisch	L/250
C2 - V1 (0.000-1.200)	Vloer L/500	Scheurvorming	0	0	Parabolisch	L/250
C3 - V1 (0.000-1.200)	Vloer L/333	gevoelige wanden Algemeen	0	0	Parabolisch	L/250
C4 - V1 (0.000-2.300)	Vloer L/333	Algemeen	0	0	Parabolisch	L/250
C5 - V1 (0.000-0.500)	Vloer L/333	Algemeen	0	0	Parabolisch	L/250
C6 - V1 (0.000-1.200)	Vloer L/333	Algemeen	0	0	Parabolisch	L/250
C7 - V1 (0.000-2.300)	Vloer L/333	Algemeen	0	0	Parabolisch	L/250
C8 - V1 (0.000-0.500)	Vloer L/333	Algemeen	0	0	Parabolisch	L/250

UNITY CHECK

Label	Toetsing	Combinatie	Artikel	UC max
C1	Doorsnede	Fu.C.2	NEN-EN1995-1-1#6.1.6 (6.11)	0,22
	Kip	Fu.C.2	NEN-EN1995-1-1#6.3.3 (6.33)	0,22
	Doorbuiging	Ka.C.2	NEN-EN1995#7.2 NEN-EN1990#A1.4.3(4)	0,03
C2	Doorsnede	Fu.C.4	NEN-EN1995-1-1#6.1.8 (6.14)	0,29
	Kip	Fu.C.1	NEN-EN1995-1-1#6.3.3 (6.33)	0,04
	Doorbuiging	Ka.C.2	NEN-EN1995#7.2 NEN-EN1990#A1.4.3(4)	0,02
C3	Doorsnede	Fu.C.1	NEN-EN1995-1-1#6.1.6 (6.11)	0,48
	Kip	Fu.C.1	NEN-EN1995-1-1#6.3.3 (6.33)	0,48
	Doorbuiging	Ka.C.2	NEN-EN1995#7.2 NEN-EN1990#A1.4.3(4)	0,14
C4	Doorsnede	Fu.C.1	NEN-EN1995-1-1#6.1.6 (6.11)	0,53
	Kip	Fu.C.1	NEN-EN1995-1-1#6.3.3 (6.33)	0,53
	Doorbuiging	Ka.C.2	NEN-EN1995#7.2 NEN-EN1990#A1.4.3(4)	0,46
C5	Doorsnede	Fu.C.1	NEN-EN1995-1-1#6.1.6 (6.11)	0,23
	Kip	Fu.C.1	NEN-EN1995-1-1#6.3.3 (6.33)	0,23
	Doorbuiging	Ka.C.2	NEN-EN1995#7.2 NEN-EN1990#A1.4.3(4)	0,03
C6	Doorsnede	Fu.C.1	NEN-EN1995-1-1#6.1.6 (6.11)	0,56
	Kip	Fu.C.1	NEN-EN1995-1-1#6.3.3 (6.33)	0,56
	Doorbuiging	Ka.C.2	NEN-EN1995#7.2 NEN-EN1990#A1.4.3(4)	0,18
C7	Doorsnede	Fu.C.1	NEN-EN1995-1-1#6.1.6 (6.11)	0,61
	Kip	Fu.C.1	NEN-EN1995-1-1#6.3.3 (6.33)	0,61
	Doorbuiging	Ka.C.2	NEN-EN1995#7.2 NEN-EN1990#A1.4.3(4)	0,61

C8	Doorsnede	Fu.C.1	NEN-EN1995-1-1#6.1.6 (6.11)	0,28
	Kip	Fu.C.1	NEN-EN1995-1-1#6.3.3 (6.33)	0,28
	Doorbuiging	Ka.C.2	NEN-EN1995#7.2 NEN-EN1990#A1.4.3(4)	0,04

8.9 Bijlage uitraai MatrixFrame berekening Pos 9

AFB. GEOMETRIE LIGGER

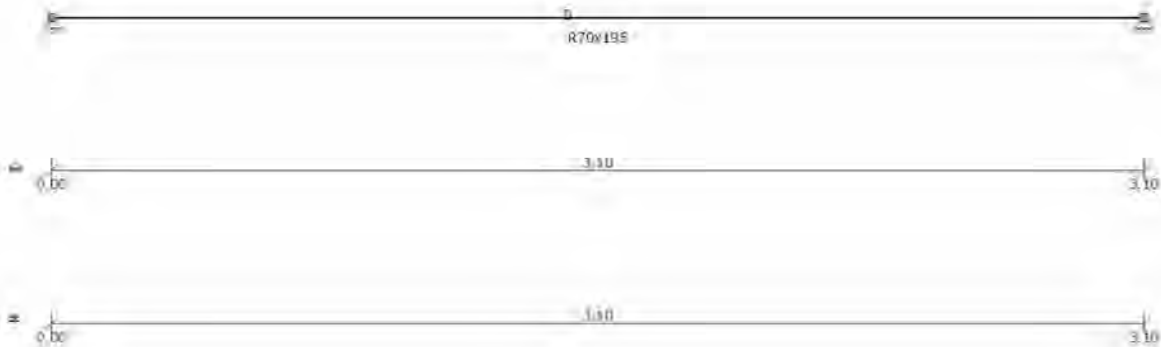

BALKGEOMETRIE

Positie	Profielnaam	5.1.2.e	Traagheidsmoment	Materiaal	E-Modulus	Uitzettingcoeff
0.000 - L(3.100)	R70x195	0	4.3253e-05	C24	1.1000e+07	50.0000e-07
0.06	m -	o	m4 -		kN/m ²	C°m
	kN/m					

PROFIELVORMEN

Profiel	Verl. h.	hB	hE	tf	tw	tf2	B	bL	bR	Raatl.
P3	Nee	0,195	0,195	0,0000	0,0000	0,0000	0,070	0,000	0,000	Nee
-	-	m	m	m	m	m	m	m	m	m

MATERIALEN

Materiaalnaam	Poison	Dichtheid	E-Modulus	Uitzettingcoeff
C24	0.40	4.20	1.1000e+07	50.0000e-07
-	-	kN/m ³	kN/m ²	C°m

OPLEGGINGEN

Oplegging	Positie	Z	Yr
O1	0.000	vast	vrij
O2	L(3.100)	vast	vrij
-	m	kN/m	kNm/rad

BELASTINGSGEVALLEN TYPEN

Oplegg.	Staven	5.1.2.e	Gunstig/Ong. Element	5.1.2.e	Psi0	Psi1	Cprob
Psi2	UGT/GGT						
B.G.1	Permanent	Permanent	-	N.v.t.	N.v.t.		
B.G.2	Verdeelde veranderlijke	Verdeelde	-	Cat. A) Vloeren	1	1	0.40 0.50
0.30	1.00/1.00 belasting	veranderlijke belasting					
B.G.3	Geconcentreerde	Geconcentreerde	-	Cat. A) Vloeren	N.v.t.	N.v.t.	0.40 0.50
0.30	veranderlijke belasting	veranderlijke belasting					
B.G.2.1	Verdeelde veranderlijke	Verdeelde	-	Cat. A) Vloeren	1	1	0.40 0.50
0.30	1.00/1.00 belasting	veranderlijke belasting					

AFB. LASTEN B.G.1 PERMANENT

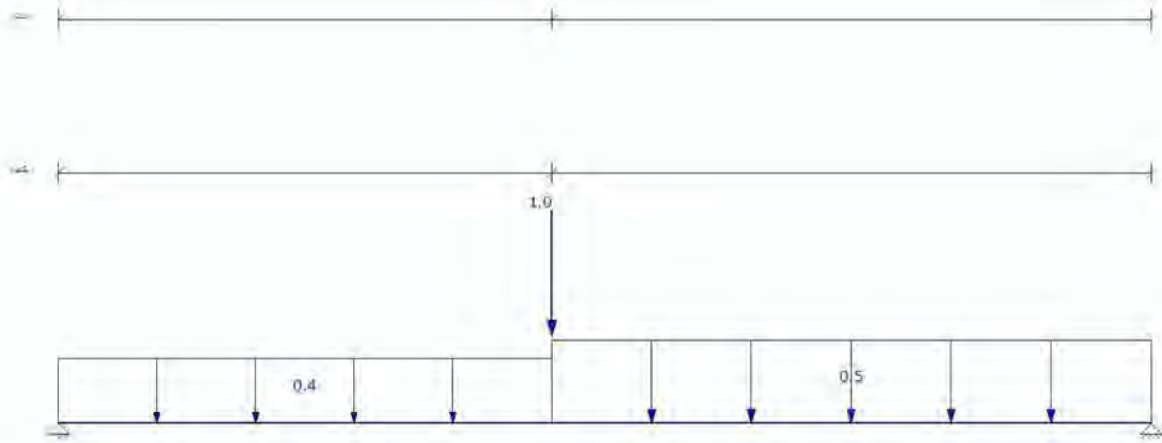

AFB. LASTEN B.G.2 VERDEELDE VERANDERLIJKE BELASTING

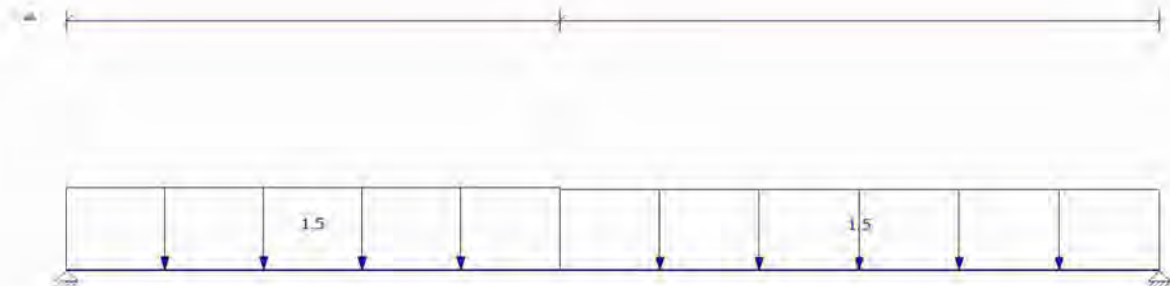

AFB. LASTEN B.G.3 GECONCENTREERDE VERANDERLIJKE BELASTING

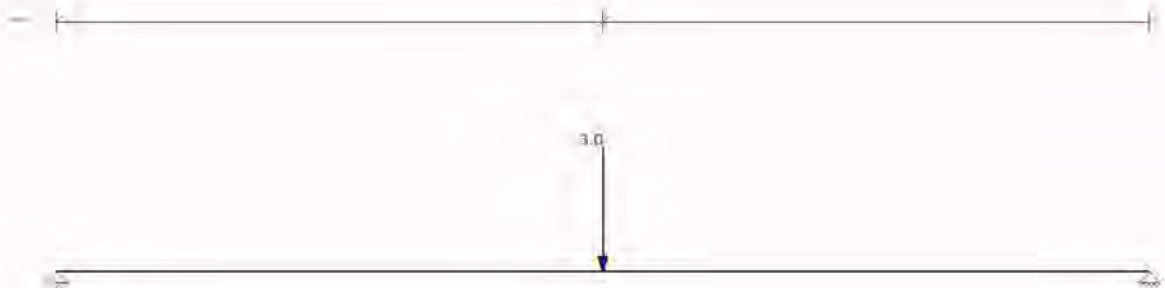

AFB. LASTEN B.G.2.1 VERDEELDE VERANDERLIJKE BELASTING

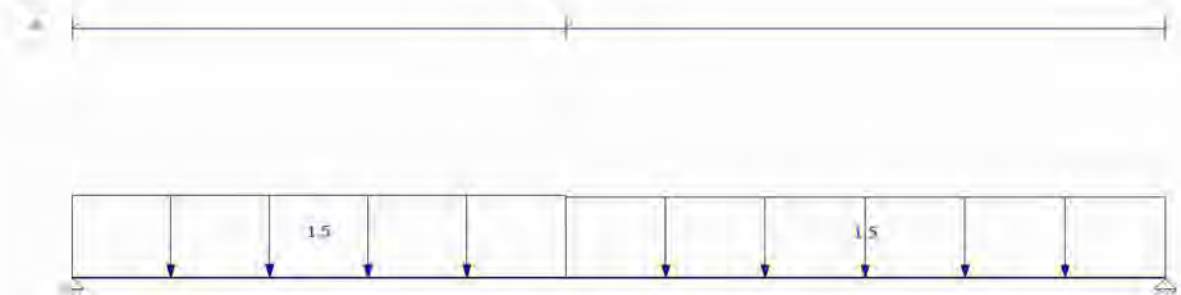

FUNDAMENTEEL BELASTINGSCOMBINATIES (TABEL)

B.G.	Omschrijving	Fu.C.1	Fu.C.2	Fu.C.3	Fu.C.4
B.G.1	Permanent	1.20	1.20	1.35	1.35
B.G.2	Verdeelde veranderlijke belasting	-	-	-	-
B.G.3	Geconcentreerde veranderlijke belasting	-	1.50	-	0.60
B.G.2.1	Verdeelde veranderlijke belasting	1.50	-	0.60	-

KARAKTERISTIEK BELASTINGSCOMBINATIES (TABEL)

B.G.	Omschrijving	Ka.C.(w1)	Ka.C.1	Ka.C.2
B.G.1	Permanent	1.00	1.00	1.00
B.G.2	Verdeelde veranderlijke belasting	-	-	-
B.G.3	Geconcentreerde veranderlijke belasting	-	-	-
B.G.2.1	Verdeelde veranderlijke belasting	-	0.40	1.00

FREQUENT BELASTINGSCOMBINATIES (TABEL)

B.G.	Omschrijving	Fr.C.(w1)	Fr.C.1
B.G.1	Permanent	1.00	1.00
B.G.2	Verdeelde veranderlijke belasting	-	-
B.G.3	Geconcentreerde veranderlijke belasting	-	-
B.G.2.1	Verdeelde veranderlijke belasting	-	0.50

QUASI-PERMANENT BELASTINGSCOMBINATIES (TABEL)

B.G.	Omschrijving	Qu.C.1
B.G.1	Permanent	1.00
B.G.2	Verdeelde veranderlijke belasting	-
B.G.3	Geconcentreerde veranderlijke belasting	-
B.G.2.1	Verdeelde veranderlijke belasting	0.30

UITGANGSPUNTEN VAN DE ANALYSE

Lineaire Elastische Analyse uitgevoerd

AFB. FU.C. MOMENT (MY) OMHULLENDE

Fundamenteel Belastingscombinaties

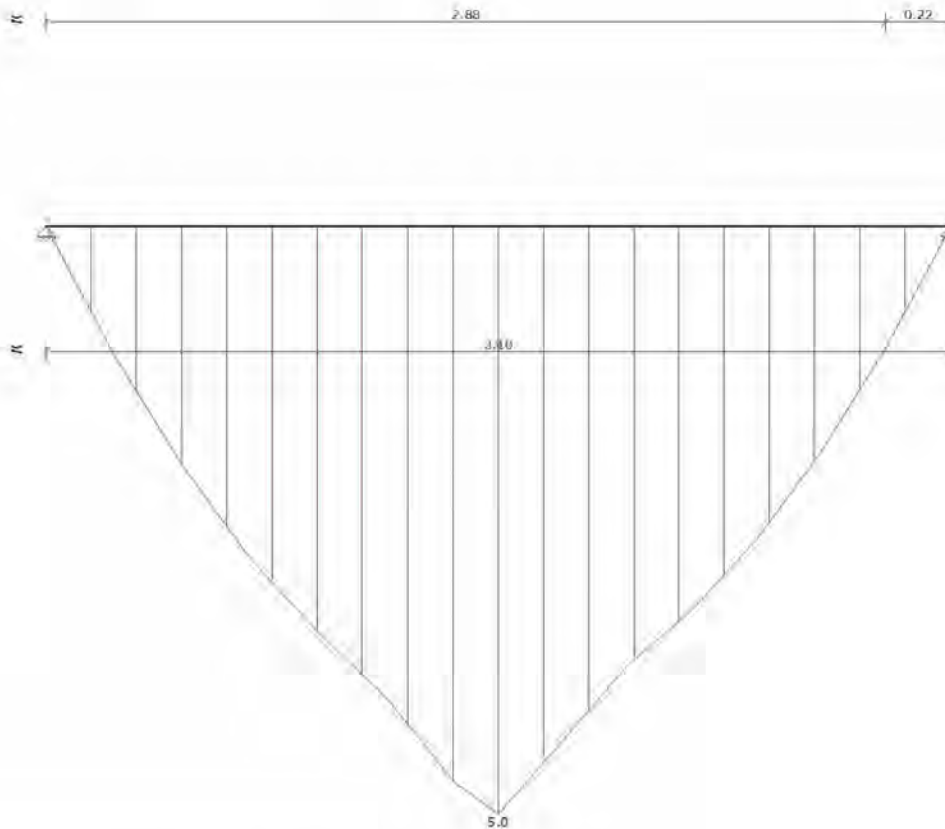

AFB. FU.C. DWARSKRACHT (VZ) OMHULLENDE

Fundamenteel Belastingscombinaties

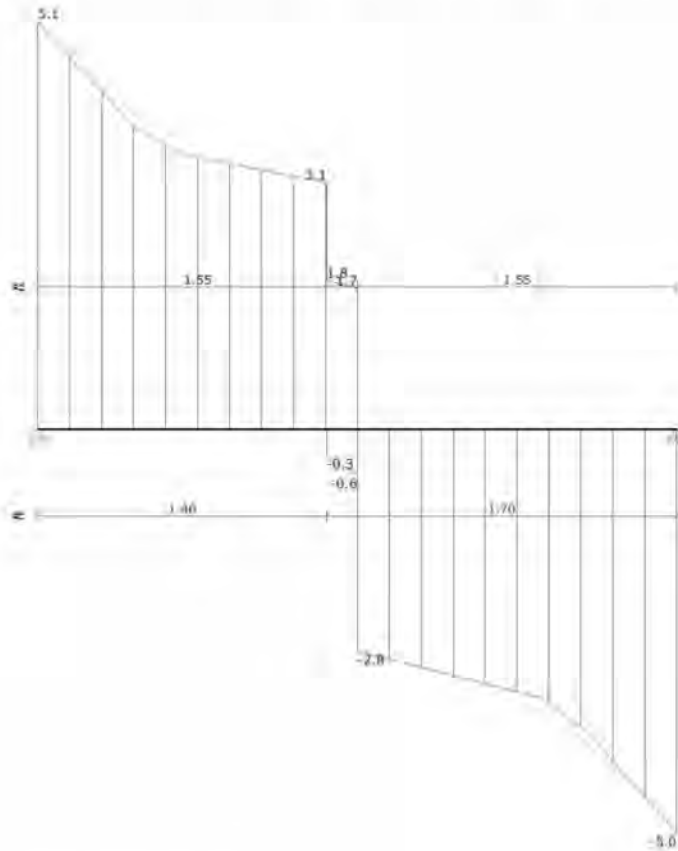

FU.C. STAAFKRACHTEN

Veld	Positie B.G.	Mb	Mmax	xMmax	Me	x-M0	x-M0	Vb
Vmax	Ve							
Veld 1	0.000 - 3.100 Fu.C.1	0.00	4.33	1.400	0.00	0.000	0.000	5.05
5.05	-5.01							
	0.000 - 3.100 Fu.C.2	0.00	5.05	1.550	0.00	0.000	0.000	3.76
	3.76 - 3.76							
	0.000 - 3.100 Fu.C.3	0.00	2.91	1.400	0.00	0.000	0.000	3.12
	3.12 - 3.10							
	0.000 - 3.100 Fu.C.4	0.00	3.15	1.550	0.00	0.000	0.000	2.60
	2.60 - 2.59							
-	m -	kNm	kNm	m	kNm	m	m	kN
kN	kN							

AFB. FU.C. OPLEGREACTIES OMHULLENDE

Fundamenteel Belastingcombinaties



FU.C. OPLEGREACTIES

B.C.	Oplegging	Positie	Z	Yr	Z	My
Fu.C.1	O1	0.000	vast	vrij	-5.05	0.00
Fu.C.1	O2	3.100	vast	vrij	-5.01	0.00
	Som Reacties				-10.06	
	Som Lasten				10.06	
Fu.C.2	O1	0.000	vast	vrij	-3.76	0.00
Fu.C.2	O2	3.100	vast	vrij	-3.76	0.00
	Som Reacties				-7.52	
	Som Lasten				7.52	
Fu.C.3	O1	0.000	vast	vrij	-3.12	0.00
Fu.C.3	O2	3.100	vast	vrij	-3.10	0.00
	Som Reacties				-6.21	
	Som Lasten				6.21	
Fu.C.4	O1	0.000	vast	vrij	-2.60	0.00
Fu.C.4	O2	3.100	vast	vrij	-2.59	0.00
	Som Reacties				-5.20	
	Som Lasten				5.20	
-	-	m	kN/m	kNm/rad	kN	kNm

B.G. OPLEGREACTIES

B.C.	Oplegging	Positie	Z	Yr	Z	My
B.G.1	O1	0.000	vast	vrij	-1.26	0.00
B.G.1	O2	3.100	vast	vrij	-1.26	0.00
	Som Reacties				-2.52	
	Som Lasten				2.52	
B.G.2.1	O1	0.000	vast	vrij	-2.36	0.00
B.G.2.1	O2	3.100	vast	vrij	-2.33	0.00
	Som Reacties				-4.69	
	Som Lasten				4.69	
B.G.3	O1	0.000	vast	vrij	-1.50	0.00
B.G.3	O2	3.100	vast	vrij	-1.50	0.00
	Som Reacties				-3.00	
	Som Lasten				3.00	
-	-	m	kN/m	kNm/rad	kN	kNm

AFB. KA.C. VERPLAATSINGEN OMHULLENDE

Karakteristiek Belastingscombinaties



KA.C. KNOOPVERPLAATSINGEN

Knoop	B.C.	Z	Yr
-------	------	---	----

K1	Ka.C.(w1)	0.0000	-2.560e-03
	Ka.C.1	0.0000	-4.140e-03
	Ka.C.2	0.0000	-6.511e-03
K2	Ka.C.(w1)	0.0000	2.516e-03
	Ka.C.1	0.0000	4.093e-03
	Ka.C.2	0.0000	6.459e-03
-	-	m	rad

KA.C. DOORBUIGINGEN

Veld	Positie B.C.	Veld Begin	Z'afst	Veld		Veld Eind	
				Z'	Z' glb dist	Z' glb	
S1	0.000 - 3.100 Ka.C.(w1)	0,0000	1.531	0,0025	1.531	0.0025	0,0000
S1	0.000 - 3.100 Ka.C.1	0,0000	1.537	0,0041	1.537	0.0041	0,0000
S1	0.000 - 3.100 Ka.C.2	0,0000	1.541	0,0064	1.541	0.0064	0,0000
-	m -	m	m	m	m	m	m

AFB. HOUTCONTROLE

C1 - k/ds/bg

SAMENSTELLING CONSTRUCTIEDELEN

Constructiedeel	Staaft/staven
C1	S1

STABILITEITSGEGEVENS

Staaft	Profiel	Y-As (assenstelsel)				Z-As(assenstelsel)	
		Lsys	Methode	Lkip	Lkip/Lsys	Methode	Lkip
C1 - V1 (0.000-3.100)	P3	3.100	Conservatief	3.100	1.00	Conservatief	3.100
1.00		geschoord				geschoord	
-	-	m -		m	-	-	m -

KIPSTEUNENGEGEVENS

Staaft last	Profiel	Begin	Eind	Kipsteunen boven	Kipsteunen onder	Aangrijppunt
C1 - V1 (0.000-3.100)	P3	inklemming	inklemming			Neutraal
-	-	Volledig vast	Volledig vast	m	m	-

DOORBUIGINGGEGEVENS

Staaft w;2+w;3	Constr.type	Toetsingstype	Zeeg Y'	Zeeg Z'	Zeegvorm	w;max
C1 - V1 (0.000-3.100)	Vloer	Algemeen	0	0	Parabolisch	L/250
L/333			mm	mm	-	-

UNITY CHECK

Label	Toetsing	Combinatie	Artikel	UC max
C1	Doorsnede	Fu.C.2	NEN-EN1995-1-1#6.1.6 (6.11)	0.77
	Kip	Fu.C.2	NEN-EN1995-1-1#6.3.3 (6.33)	0.77
	Doorbuiging	Ka.C.2	NEN-EN1995#7.2 NEN-EN1990#A1.4.3(4)	0.69

8.10 Bijlage uitraai MatrixFrame berekening Pos 10

AFB. GEOMETRIE LIGGER

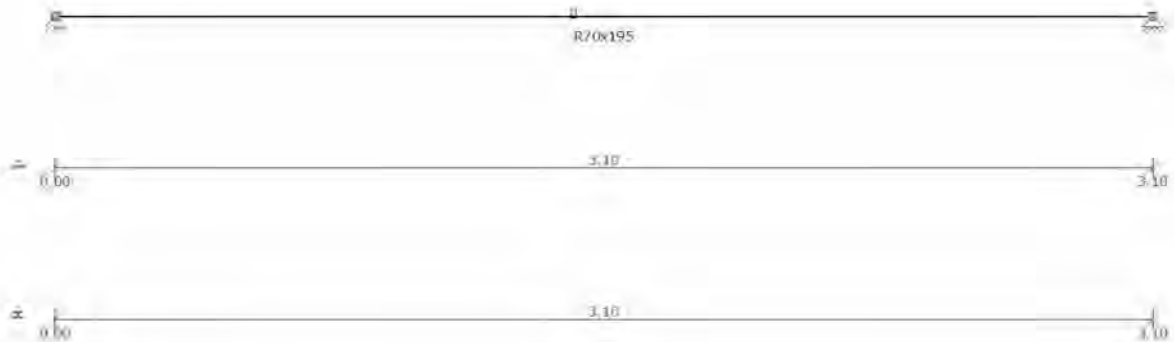

BALKGEOMETRIE

Positie	Profielnaam	5.1.2.e	Traagheidsmoment	Materiaal	E-Modulus	Uitzettingcoeff
0,000 - 0,06	L(3,100) R70x195	0	4.3253e-05	C24	1.1000e+07	50.0000e-07
	m -	°	m4 -		kN/m2	C°m
	kN/m					

PROFIELVORMEN

Profiel	Verl. h.	hB	hE	tf	tw	tf2	B	bL	bR	Raatl.
P3	Nee	0,195	0,195	0,0000	0,0000	0,0000	0,070	0,000	0,000	Nee
-	-	m	m	m	m	m	m	m	m	m

MATERIALEN

Materiaalnaam	Poison	Dichtheid	E-Modulus	Uitzettingcoeff
C24	0.40	4.20	1.1000e+07	50.0000e-07
-	-	kN/m3	kN/m2	C°m

OPLEGGINGEN

Oplegging	Positie	Z	Yr
O1	0,000	vast	vrij
O2	L(3,100)	vast	vrij
-	m	kN/m	kNm/rad

BELASTINGSGEVALLEN TYPEN

Oplegg.	Staven	5.1.2.e	Gunstig/Ong.	Element	5.1.2.e	Psi0	Psi1	Cprob
Psi2	UGT/GGT							
B.G.1	Permanent	Permanent	-		N.v.t.	N.v.t.		
B.G.2	Verdeelde veranderlijke	Verdeelde	-	Cat. A) Vloeren	1	1	0.40	0.50
0.30	1.00/1.00							
	belasting	veranderlijke						
B.G.3	Geconcentreerde	Geconcentreerde	-	Cat. A) Vloeren	N.v.t.	N.v.t.	0.40	0.50
0.30								
	veranderlijke belasting	veranderlijke						
B.G.2.1	Verdeelde veranderlijke	Verdeelde	-	Cat. A) Vloeren	1	1	0.40	0.50
0.30	1.00/1.00							
	belasting	veranderlijke						
		belasting						

AFB. LASTEN B.G.1 PERMANENT

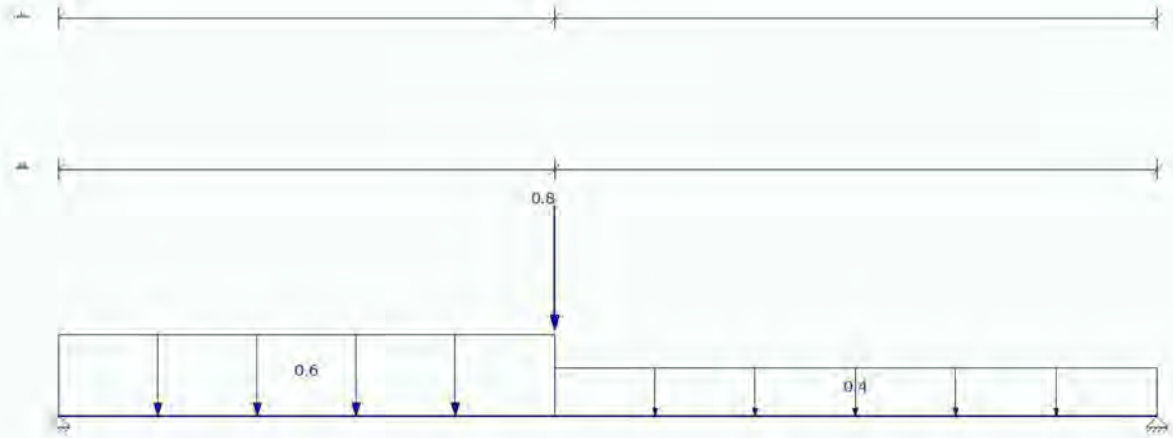

AFB. LASTEN B.G.2 VERDEELDE VERANDERLIJKE BELASTING

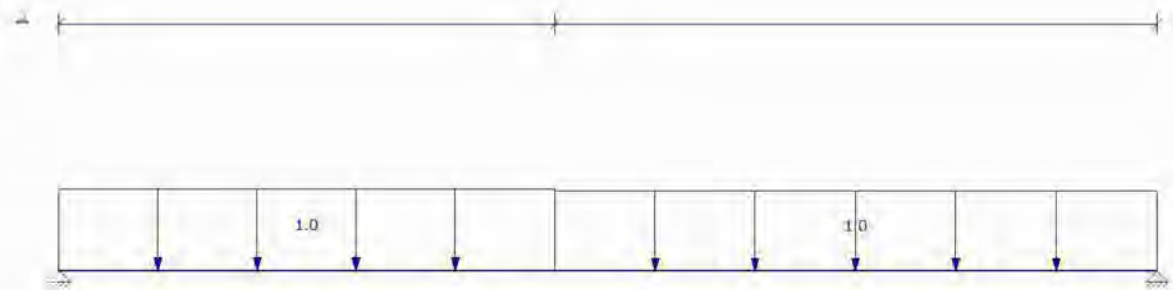

AFB. LASTEN B.G.3 GECONCENTREERDE VERANDERLIJKE BELASTING

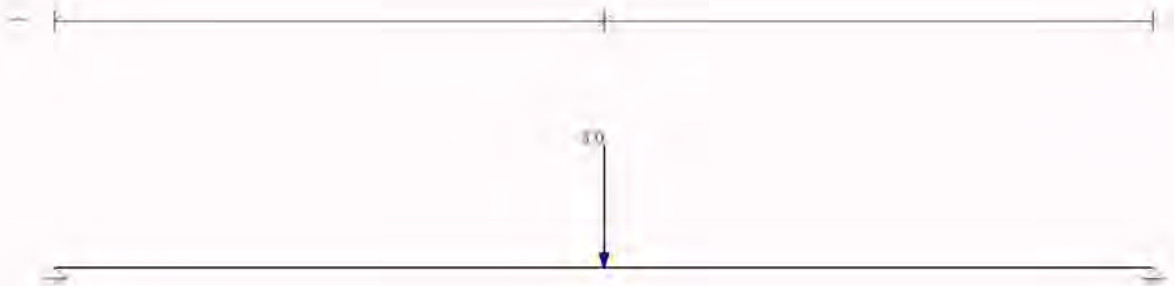

AFB. LASTEN B.G.2.1 VERDEELDE VERANDERLIJKE BELASTING

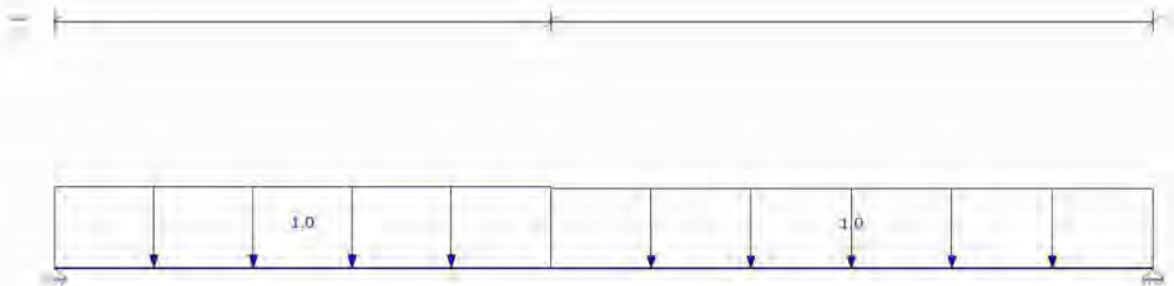

FUNDAMENTEEL BELASTINGSCOMBINATIES (TABEL)

B.G.	Omschrijving	Fu.C.1	Fu.C.2	Fu.C.3	Fu.C.4
B.G.1	Permanent	1.20	1.20	1.35	1.35
B.G.2	Verdeelde veranderlijke belasting	-	-	-	-
B.G.3	Geconcentreerde veranderlijke belasting	-	1.50	-	0.60
B.G.2.1	Verdeelde veranderlijke belasting	1.50	-	0.60	-

KARAKTERISTIEK BELASTINGSCOMBINATIES (TABEL)

B.G.	Omschrijving	Ka.C.(w1)		Ka.C.1	Ka.C.2
B.G.1	Permanent	1.00	1.00	1.00	
B.G.2	Verdeelde veranderlijke belasting	-	-	-	
B.G.3	Geconcentreerde veranderlijke belasting	-	-	-	
B.G.2.1	Verdeelde veranderlijke belasting	-	0.40	1.00	

FREQUENT BELASTINGSCOMBINATIES (TABEL)

B.G.	Omschrijving	Fr.C.(w1)	Fr.C.1
B.G.1	Permanent	1.00	1.00
B.G.2	Verdeelde veranderlijke belasting	-	-
B.G.3	Geconcentreerde veranderlijke belasting	-	-
B.G.2.1	Verdeelde veranderlijke belasting	-	0.50

QUASI-PERMANENT BELASTINGSCOMBINATIES (TABEL)

B.G.	Omschrijving	Qu.C.1
B.G.1	Permanent	1.00
B.G.2	Verdeelde veranderlijke belasting	-
B.G.3	Geconcentreerde veranderlijke belasting	-
B.G.2.1	Verdeelde veranderlijke belasting	0.30

UITGANGSPUNTEN VAN DE ANALYSE

Lineaire Elastische Analyse uitgevoerd

AFB. FU.C. MOMENT (MY) OMHULLENDE

Fundamenteel Belastingscombinaties

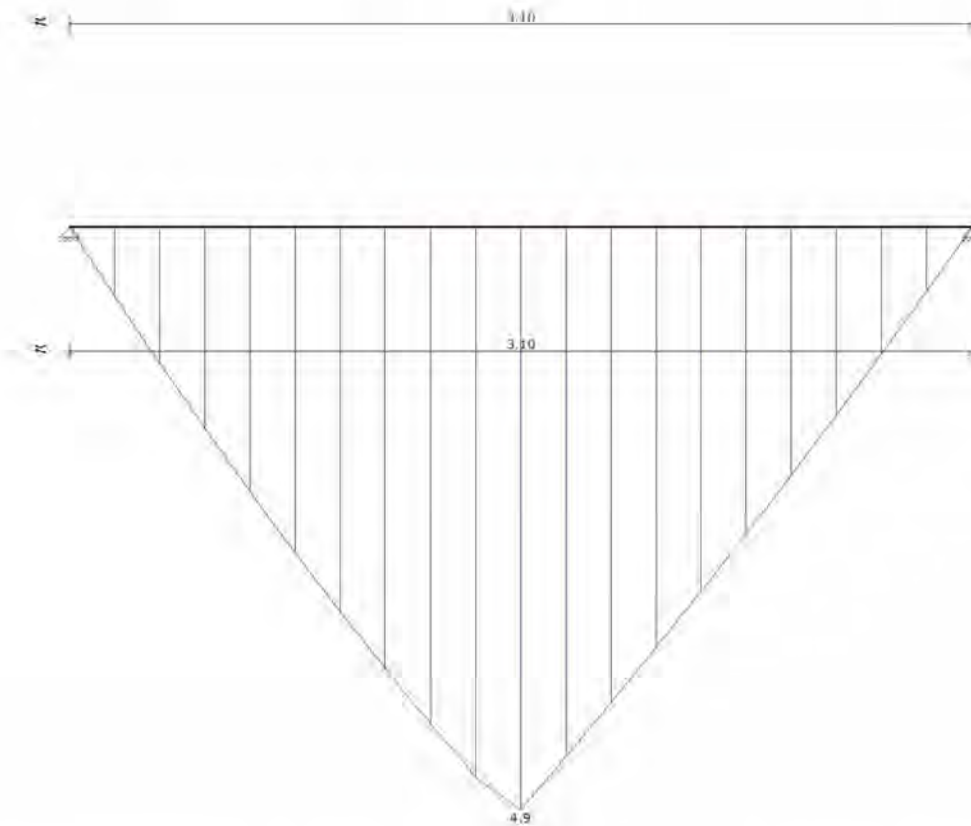

AFB. FU.C. DWARSKRACHT (VZ) OMHULLENDE

Fundamenteel Belastingscombinaties

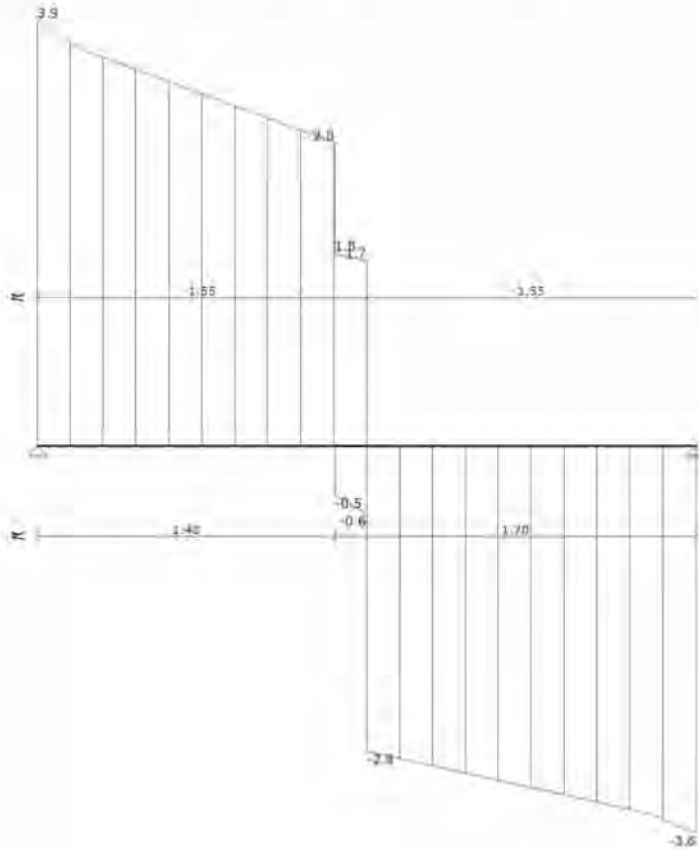

FU.C. STAAFKRACHTEN

Veld	Positie B.G.	Mb	Mmax	xMmax	Me	x-M0	x-M0	Vb
Vmax	Ve							
Veld 1	0,000 - 3,100 Fu.C.1	0,00	3,25	1,400	0,00	0,000	0,000	3,90
3,90	-3,56							
	0,000 - 3,100 Fu.C.2	0,00	4,86	1,550	0,00	0,000	0,000	3,79
	3,79 -3,47							
	0,000 - 3,100 Fu.C.3	0,00	2,35	1,400	0,00	0,000	0,000	2,68
	2,68 -2,31							
	0,000 - 3,100 Fu.C.4	0,00	2,94	1,550	0,00	0,000	0,000	2,63
	2,63 -2,27							
-	m -	kNm	kNm	m	kNm	m	m	kN
kN	kN							

AFB. FU.C. OPLEGREACTIES OMHULLENDE

Fundamenteel Belastingscombinaties



FU.C. OPLEGREACTIES

B.C.	Oplegging	Positie	Z	Yr	Z	My
Fu.C.1	O1	0.000	vast	vrij	-3.90	0.00
Fu.C.1	O2	3.100	vast	vrij	-3.56	0.00
	Som Reacties				-7.46	
	Som Lasten				7.46	
Fu.C.2	O1	0.000	vast	vrij	-3.79	0.00
Fu.C.2	O2	3.100	vast	vrij	-3.47	0.00
	Som Reacties				-7.27	
	Som Lasten				7.27	
Fu.C.3	O1	0.000	vast	vrij	-2.68	0.00
Fu.C.3	O2	3.100	vast	vrij	-2.31	0.00
	Som Reacties				-4.98	
	Som Lasten				4.98	
Fu.C.4	O1	0.000	vast	vrij	-2.63	0.00
Fu.C.4	O2	3.100	vast	vrij	-2.27	0.00
	Som Reacties				-4.91	
	Som Lasten				4.91	
-	-	m	kN/m	kNm/rad	kN	kNm

B.G. OPLEGREACTIES

B.C.	Oplegging	Positie	Z	Yr	Z	My
B.G.1	O1	0.000	vast	vrij	-1.28	0.00
B.G.1	O2	3.100	vast	vrij	-1.02	0.00
	Som Reacties				-2.30	
	Som Lasten				2.30	
B.G.2.1	O1	0.000	vast	vrij	-1.57	0.00
B.G.2.1	O2	3.100	vast	vrij	-1.56	0.00
	Som Reacties				-3.13	
	Som Lasten				3.13	
B.G.3	O1	0.000	vast	vrij	-1.50	0.00
B.G.3	O2	3.100	vast	vrij	-1.50	0.00
	Som Reacties				-3.00	
	Som Lasten				3.00	
-	-	m	kN/m	kNm/rad	kN	kNm

AFB. KA.C. VERPLAATSINGEN OMHULLENDE

Karakteristiek Belastingscombinaties



KA.C. KNOOPVERPLAATSINGEN

Knoop	B.C.	Z	Yr
K1	Ka.C.(w1)	0.0000	-2.343e-03
	Ka.C.1	0.0000	-3.396e-03
	Ka.C.2	0.0000	-4.977e-03
K2	Ka.C.(w1)	0.0000	2.197e-03
	Ka.C.1	0.0000	3.248e-03
	Ka.C.2	0.0000	4.825e-03
-	-	m	rad

KA.C. DOORBUIGINGEN

Veld	Positie B.C.	Veld Begin	Veld		Veld Eind	
			Z'afst	Z'	Z' glb dist	Z' glb
S1	0.000 - 3.100 Ka.C.(w1)	0,0000	1.510	0,0023	1.510	0.0023 0,0000
S1	0.000 - 3.100 Ka.C.1	0,0000	1.521	0,0033	1.521	0.0033 0,0000
S1	0.000 - 3.100 Ka.C.2	0,0000	1.530	0,0048	1.530	0.0048 0,0000
-	m -	m	m	m	m	m m

AFB. HOUTCONTROLE

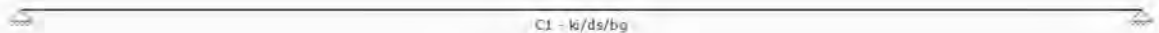

SAMENSTELLING CONSTRUCTIEDELEN

Constructiedeel	Staal/staven
C1	S1

STABILITEITSGEGEVENS

Staal	Profiel	Y-As (assenstelsel)				Z-As (assenstelsel)	
		Lsys	Methode	Lkip	Lkip/Lsys	Methode	Lkip
C1 - V1 (0.000-3.100)	P3	3.100	Conservatief	3.100	1.00	Conservatief	3.100
1.00			geschoord			geschoord	
-	-	m	-	m	-	-	m

KIPSTEUNENGEGEVENS

Staaflast	Profiel	Begin	Eind	Kipsteunen boven	Kipsteunen onder	Aangrijppunt
C1 - V1 (0.000-3.100)	P3	inklemming	inklemming			Neutraal
-	-	Volledig vast	Volledig vast	m	m	-

DOORBUIGINGGEGEVENS

Staaflast w;2+w;3	Constr.type	Toetsingstype	Zeeg Y'	Zeeg Z'	Zeegvorm	w;max
C1 - V1 (0.000-3.100)	Vloer	Scheurvorming	0	0	Parabolisch	L/250
L/500	-	gevoelige wanden	mm	mm	-	-

UNITY CHECK

Label	Toetsing	Combinatie	Artikel	UC max
C1	Doorsnede	Fu.C.2	NEN-EN1995-1-1#6.1.6 (6.11)	0.74
	Kip	Fu.C.2	NEN-EN1995-1-1#6.3.3 (6.33)	0.74
	Doorbuiging	Ka.C.2	NEN-EN1995#7.2 NEN-EN1990#A1.4.3(4)	0.70

8.11 Bijlage uitraai MatrixFrame berekening Pos 11

AFB. GEOMETRIE LIGGER

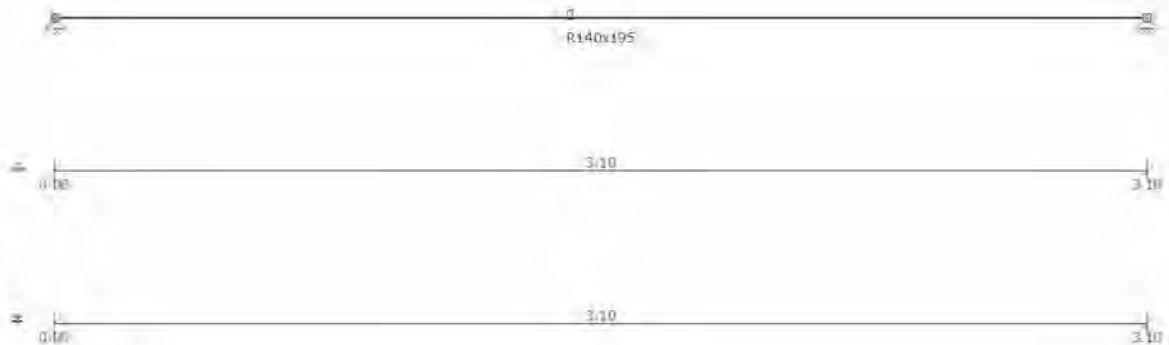

BALKGEOMETRIE

Positie	Profielnaam	5.1.2.e	Traagheidsmoment	Materiaal	E-Modulus	Uitzettingcoeff
0.000 - L(3.100)	R140x195	0	8.6507e-05	C24	1.1000e+07	50.0000e-07
0.11						
	m -	°	m ⁴ -		kN/m ²	C°m
	kN/m					

PROFIELVORMEN

Profiel	Verl. h.	hB	hE	tf	tw	tf2	B	bL	bR	Raatl.
P4	Nee	0,195	0,195	0,0000	0,0000	0,0000	0,140	0,000	0,000	Nee 0,000
-	-	m	m	m	m	m	m	m	m	m - m

MATERIALEN

Materiaalnaam	Poison	Dichtheid	E-Modulus	Uitzettingcoeff
C24	0.40	4.20	1.1000e+07	50.0000e-07
-	-	kN/m ³	kN/m ²	C°m

OPLEGGINGEN

Oplegging	Positie	Z	Yr
O1	0.000	vast	vrij
O2	L(3.100)	vast	vrij
-	m	kN/m	kNm/rad

BELASTINGSGEVALLEN TYPEN

Oplegg.	Staven	5.1.2.e	Gunstig/Ong. Element	5.1.2.e	Psi0	Psi1	Cprob
Psi2	UGT/GGT						
B.G.1	Permanent	Permanent	-	N.v.t.	N.v.t.		
B.G.2	Verdeelde veranderlijke	Verdeelde	-	1	1	0.40	0.50
0.30	1.00/1.00		Cat. A) Vloeren				
	belasting	veranderlijke					
		belasting					
B.G.3	Geconcentreerde	Geconcentreerde	-	N.v.t.	N.v.t.	0.40	0.50
0.30			Cat. A) Vloeren				
	veranderlijke belasting	veranderlijke					
		belasting					
B.G.2.1	Verdeelde veranderlijke	Verdeelde	-	1	1	0.40	0.50
0.30	1.00/1.00		Cat. A) Vloeren				
	belasting	veranderlijke					

belasting

AFB. LASTEN B.G.1 PERMANENT

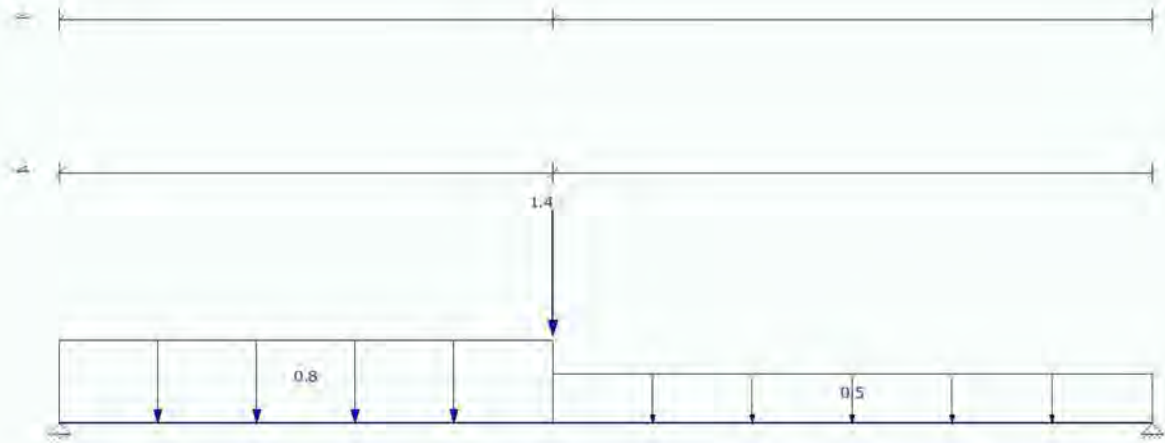

AFB. LASTEN B.G.2 VERDEELDE VERANDERLIJKE BELASTING

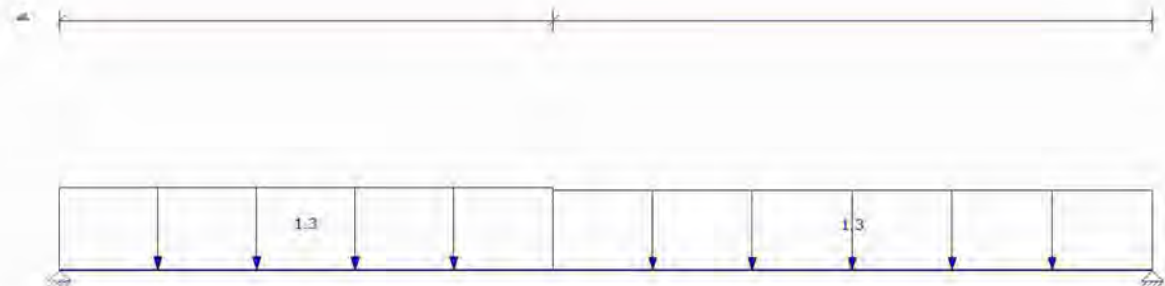

AFB. LASTEN B.G.3 GECONCENTREERDE VERANDERLIJKE BELASTING

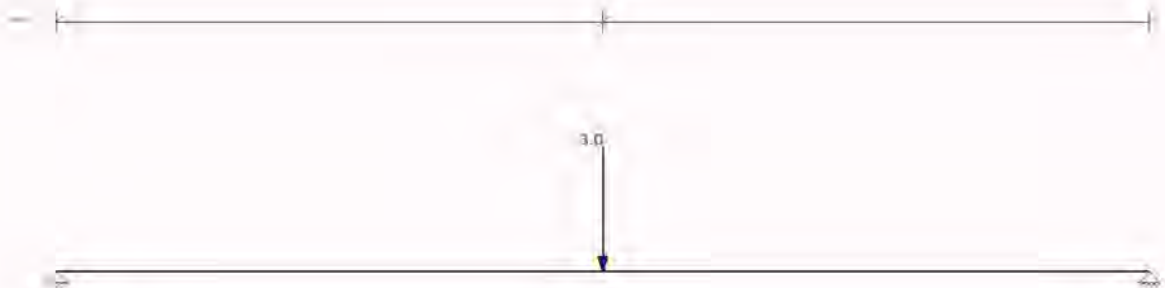

AFB. LASTEN B.G.2.1 VERDEELDE VERANDERLIJKE BELASTING



FUNDAMENTEEL BELASTINGSCOMBINATIES (TABEL)

B.G.	Omschrijving	Fu.C.1	Fu.C.2	Fu.C.3	Fu.C.4
B.G.1	Permanent	1.20	1.20	1.35	1.35
B.G.2	Verdeelde veranderlijke belasting	-	-	-	-
B.G.3	Geconcentreerde veranderlijke belasting	-	1.50	-	0.60
B.G.2.1	Verdeelde veranderlijke belasting	1.50	-	0.60	-

KARAKTERISTIEK BELASTINGSCOMBINATIES (TABEL)

B.G.	Omschrijving	Ka.C.(w1)	Ka.C.1	Ka.C.2
B.G.1	Permanent	1.00	1.00	1.00
B.G.2	Verdeelde veranderlijke belasting	-	-	-
B.G.3	Geconcentreerde veranderlijke belasting	-	-	-
B.G.2.1	Verdeelde veranderlijke belasting	-	0.40	1.00

FREQUENT BELASTINGSCOMBINATIES (TABEL)

B.G.	Omschrijving	Fr.C.(w1)	Fr.C.1
B.G.1	Permanent	1.00	1.00
B.G.2	Verdeelde veranderlijke belasting	-	-
B.G.3	Geconcentreerde veranderlijke belasting	-	-
B.G.2.1	Verdeelde veranderlijke belasting	-	0.50

QUASI-PERMANENT BELASTINGSCOMBINATIES (TABEL)

B.G.	Omschrijving	Qu.C.1
B.G.1	Permanent	1.00
B.G.2	Verdeelde veranderlijke belasting	-
B.G.3	Geconcentreerde veranderlijke belasting	-
B.G.2.1	Verdeelde veranderlijke belasting	0.30

UITGANGSPUNTEN VAN DE ANALYSE

Lineaire Elastische Analyse uitgevoerd

AFB. FU.C. MOMENT (MY) OMHULLENDE

Fundamenteel Belastingscombinaties

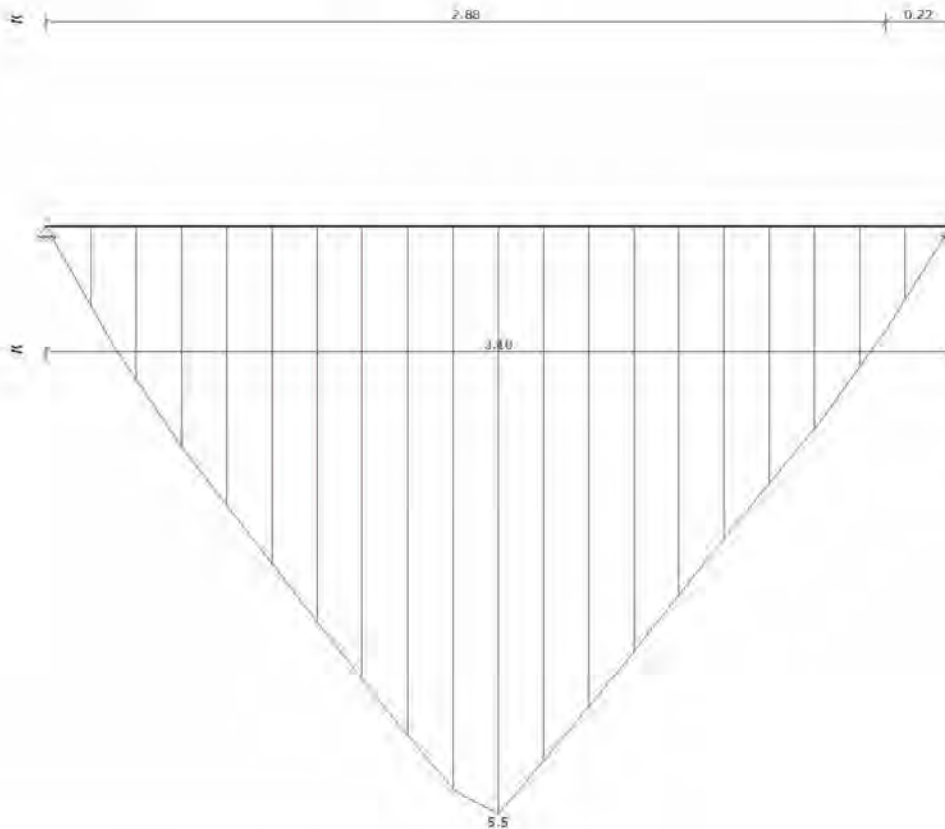

AFB. FU.C. DWARSKRACHT (VZ) OMHULLENDE

Fundamenteel Belastingscombinaties

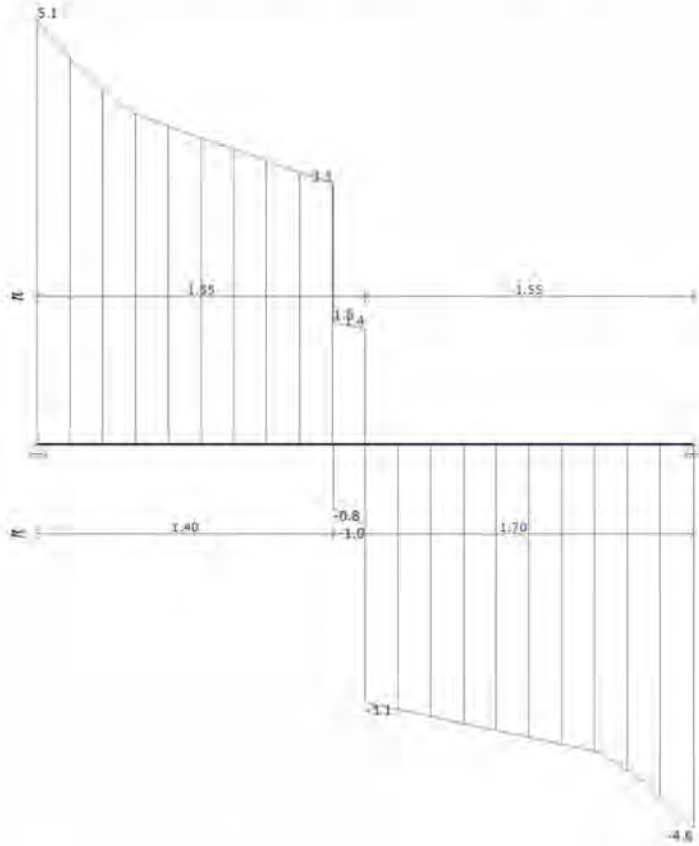

FU.C. STAAFKRACHTEN

Veld	Positie B.G.	Mb	Mmax	xMmax	Me	x-M0	x-M0	Vb
Vmax	Ve							
Veld 1	0.000 - 3.100 Fu.C.1	0.00	4.37	1.400	0.00	0.000	0.000	5.09
5.09	-4.62							
	0.000 - 3.100 Fu.C.2	0.00	5.47	1.550	0.00	0.000	0.000	4.39
	4.39 -3.95							
	0.000 - 3.100 Fu.C.3	0.00	3.27	1.400	0.00	0.000	0.000	3.58
	3.58 -3.08							
	0.000 - 3.100 Fu.C.4	0.00	3.63	1.436	0.00	0.000	0.000	3.30
	3.30 -2.81							
-	m -	kNm	kNm	m	kNm	m	m	kN
kN	kN							

AFB. FU.C. OPLEGREACTIES OMHULLENDE

Fundamenteel Belastingscombinaties

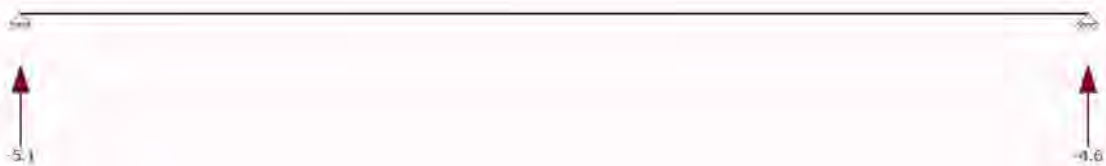

FU.C. OPLEGREACTIES

B.C.	Oplegging	Positie	Z	Yr	Z	My
Fu.C.1	O1	0.000	vast	vrij	-5.09	0.00
Fu.C.1	O2	3.100	vast	vrij	-4.62	0.00
	Som Reacties				-9.71	
	Som Lasten				9.71	
Fu.C.2	O1	0.000	vast	vrij	-4.39	0.00
Fu.C.2	O2	3.100	vast	vrij	-3.95	0.00
	Som Reacties				-8.34	
	Som Lasten				8.34	
Fu.C.3	O1	0.000	vast	vrij	-3.58	0.00
Fu.C.3	O2	3.100	vast	vrij	-3.08	0.00
	Som Reacties				-6.66	
	Som Lasten				6.66	
Fu.C.4	O1	0.000	vast	vrij	-3.30	0.00
Fu.C.4	O2	3.100	vast	vrij	-2.81	0.00
	Som Reacties				-6.11	
	Som Lasten				6.11	
-	-	m	kN/m	kNm/rad	kN	kNm

B.G. OPLEGREACTIES

B.C.	Oplegging	Positie	Z	Yr	Z	My
B.G.1	O1	0.000	vast	vrij	-1.78	0.00
B.G.1	O2	3.100	vast	vrij	-1.42	0.00
	Som Reacties				-3.19	
	Som Lasten				3.20	
B.G.2.1	O1	0.000	vast	vrij	-1.97	0.00
B.G.2.1	O2	3.100	vast	vrij	-1.95	0.00
	Som Reacties				-3.92	
	Som Lasten				3.92	
B.G.3	O1	0.000	vast	vrij	-1.50	0.00
B.G.3	O2	3.100	vast	vrij	-1.50	0.00
	Som Reacties				-3.00	
	Som Lasten				3.00	
-	-	m	kN/m	kNm/rad	kN	kNm

AFB. KA.C. VERPLAATSINGEN OMHULLENDE

Karakteristiek Belastingscombinaties



KA.C. KNOOPVERPLAATSINGEN

Knoop	B.C.	Z	Yr
-------	------	---	----

K1	Ka.C.(w1)	0.0000	-1.669e-03
	Ka.C.1	0.0000	-2.329e-03
	Ka.C.2	0.0000	-3.319e-03
K2	Ka.C.(w1)	0.0000	1.565e-03
	Ka.C.1	0.0000	2.223e-03
	Ka.C.2	0.0000	3.210e-03
-	-	m	rad

KA.C. DOORBUIGINGEN

Veld	Positie B.C.	Veld Begin	Z'afst	Veld		Veld Eind	
				Z'	Z' glb dist	Z' glb	
S1	0.000 - 3.100 Ka.C.(w1)	0,0000	1.509	0,0016	1.509	0.0016	0,0000
S1	0.000 - 3.100 Ka.C.1	0,0000	1.519	0,0023	1.519	0.0023	0,0000
S1	0.000 - 3.100 Ka.C.2	0,0000	1.528	0,0032	1.528	0.0032	0,0000
-	m -	m	m	m	m	m	m

AFB. HOUTCONTROLE

C1 - k/ds/bg

SAMENSTELLING CONSTRUCTIEDELEN

Constructiedeel	Staal/staven
C1	S1

STABILITEITSGEGEVENS

Staal	Profiel	Y-As (assenstelsel)				Z-As(assenstelsel)	
		Lsys Lkip/Lsys	Methode	Lkip	Lkip/Lsys	Methode	Lkip
C1 - V1 (0.000-3.100) 1.00	P4	3.100	Conservatief	3.100	1.00	Conservatief	3.100
-	-	geschoord m -	-	m	-	geschoord -	m -

KIPSTEUNENGEGEVENS

Staal last	Profiel	Begin	Eind	Kipsteunen boven	Kipsteunen onder	Aangrijppunt
C1 - V1 (0.000-3.100)	P4	inklemming Volledig vast	inklemming Volledig vast	m	m	Neutraal
-	-	-	-	m	m	-

DOORBUIGINGGEGEVENS

Staal w;2+w;3	Constr.type	Toetsingstype	Zeeg Y'	Zeeg Z'	Zeegvorm	w;max
C1 - V1 (0.000-3.100) L/500	Vloer	Scheurvorming	0	0	Parabolisch	L/250
-	-	gevoelige wanden	mm	mm	-	-

UNITY CHECK

Label	Toetsing	Combinatie	Artikel	UC max
C1	Doorsnede	Fu.C.2	NEN-EN1995-1-1#6.1.6 (6.11)	0.42
	Kip	Fu.C.2	NEN-EN1995-1-1#6.3.3 (6.33)	0.42
	Doorbuiging	Ka.C.2	NEN-EN1995#7.2 NEN-EN1990#A1.4.3(4)	0.46

8.12 Bijlage uitraai MatrixFrame berekening Pos 12

AFB. GEOMETRIE LIGGER

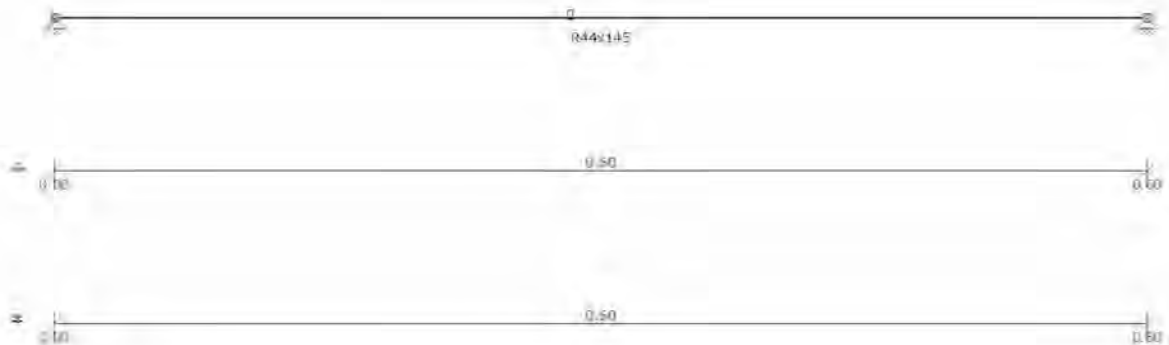

BALKGEOMETRIE

Positie	Profielnaam	5.1.2.e	Traagheidsmoment	Materiaal	E-Modulus	Uitzettingcoeff
0.000 - L(0.600)	R44x145	0	1.1178e-05	C24	1.1000e+07	50.0000e-07
0.03						
	m -			m4 -	kN/m2	C°m
	kN/m					

PROFIELVORMEN

Profiel	Verl. h.	hB	hE	tf	tw	tf2	B	bL	bR	Raatl.
P2	Nee	0,145	0,145	0,0000	0,0000	0,0000	0,044	0,000	0,000	Nee 0,000
-	-	m	m	m	m	m	m	m	m	m - m

MATERIALEN

Materiaalnaam	Poison	Dichtheid	E-Modulus	Uitzettingcoeff
C24	0.40	4.20	1.1000e+07	50.0000e-07
-	-	kN/m3	kN/m2	C°m

OPLEGGINGEN

Oplegging	Positie	Z	Yr
O1	0.000	vast	vrij
O2	L(0.600)	vast	vrij
-	m	kN/m	kNm/rad

BELASTINGSGEVALLEN TYPEN

Oplegg.	Staven	5.1.2.e	Gunstig/Ong. Element	5.1.2.e	Psi0	Psi1	Cprob
Psi2	UGT/GGT						
B.G.1	Permanent	Permanent	-	N.v.t.	N.v.t.		
B.G.2	Verdeelde veranderlijke belasting	Verdeelde veranderlijke belasting	-	Cat. H) Ontoegankelijke daken	1	1	
B.G.3	Geconcentreerde veranderlijke belasting	Geconcentreerde veranderlijke belasting	-	Cat. H) Ontoegankelijke daken	N.v.t.	N.v.t.	
B.G.4	Sneeuwbelasting	Sneeuwbelasting	-	N.v.t.	N.v.t.	0.20	
B.G.2.1	Verdeelde veranderlijke	Verdeelde	-	Cat. H) Ontoegankelijke	1	1	

1.00/1.00
belasting

veranderlijke
belasting

daken

AFB. LASTEN B.G.1 PERMANENT

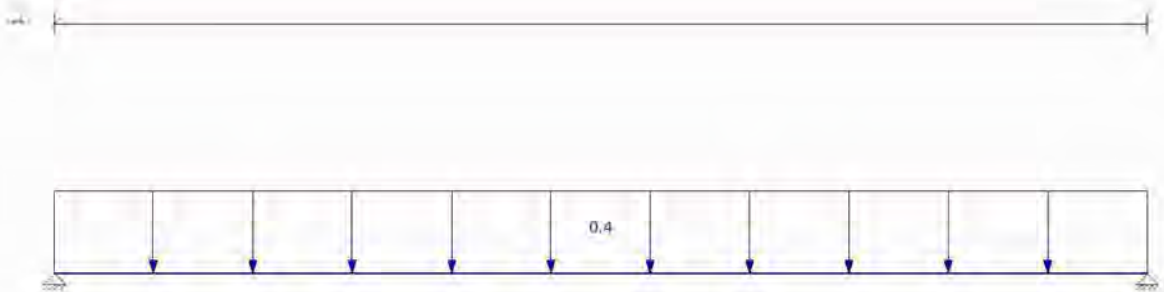

AFB. LASTEN B.G.2 VERDEELDE VERANDERLIJKE BELASTING

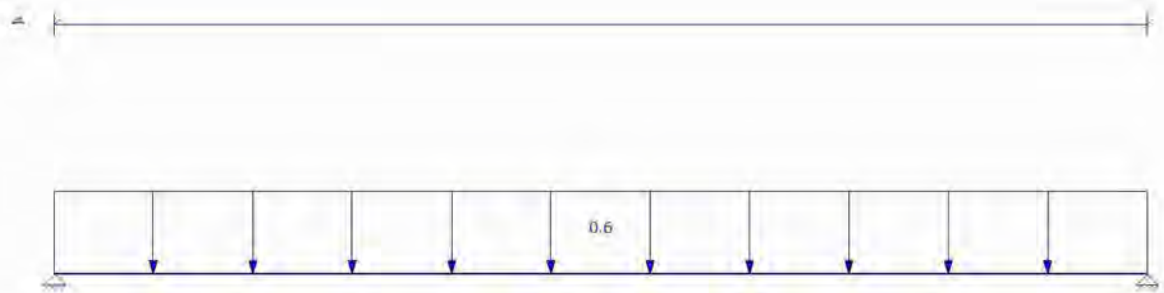

AFB. LASTEN B.G.3 GECONCENTREERDE VERANDERLIJKE BELASTING

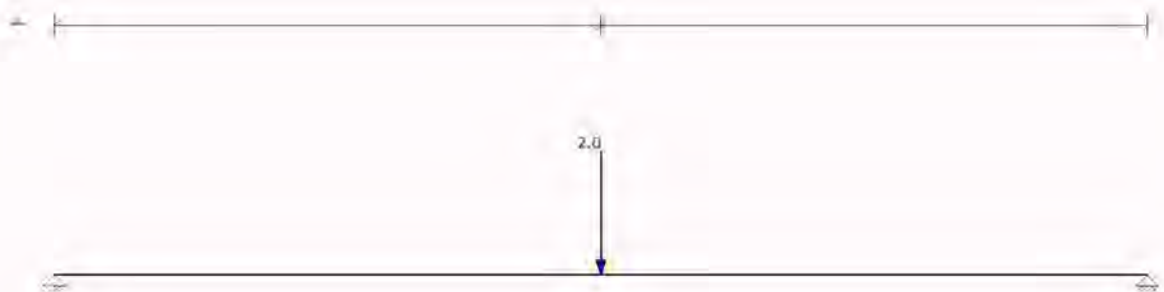

AFB. LASTEN B.G.4 SNEEUWBELASTING

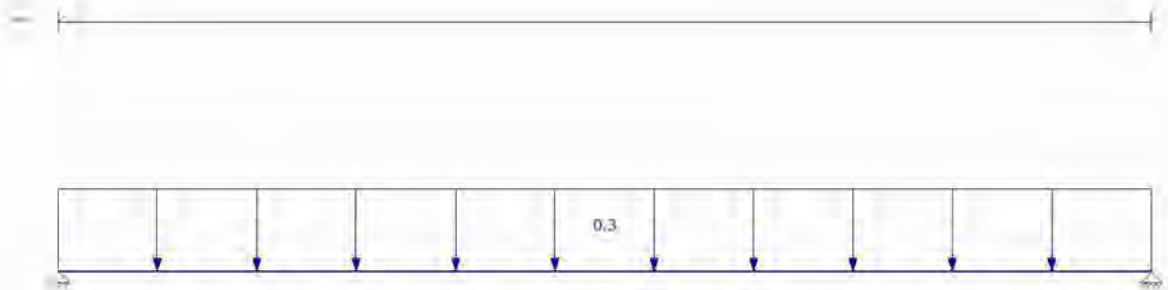

AFB. LASTEN B.G.2.1 VERDEELDE VERANDERLIJKE BELASTING

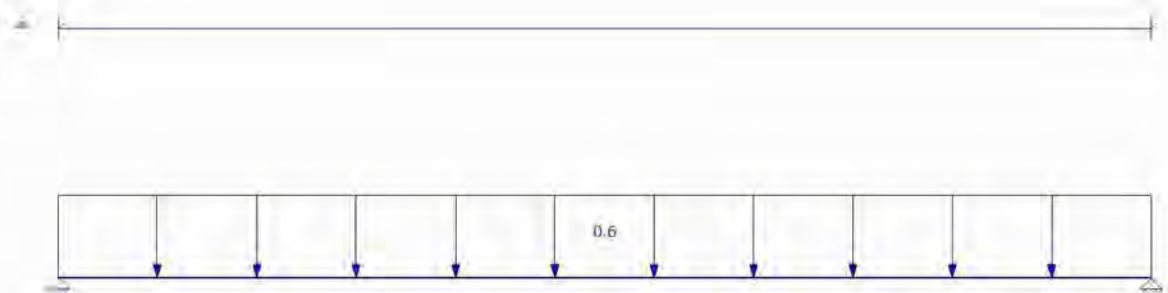

FUNDAMENTEEL BELASTINGSCOMBINATIES (TABEL)

B.G.	Omschrijving	Fu.C.1	Fu.C.2	Fu.C.3	Fu.C.4
B.G.1	Permanent	1.20	1.20	1.20	1.35
B.G.2	Verdeelde veranderlijke belasting	-	-	-	-
B.G.3	Geconcentreerde veranderlijke belasting	-	-	1.50	-
B.G.4	Sneeuwbelasting	-	1.50	-	-
B.G.2.1	Verdeelde veranderlijke belasting	1.50	-	-	-

KARAKTERISTIEK BELASTINGSCOMBINATIES (TABEL)

B.G.	Omschrijving	Ka.C.(w1)	Ka.C.1	Ka.C.2	Ka.C.3
B.G.1	Permanent	1.00	1.00	1.00	1.00
B.G.2	Verdeelde veranderlijke belasting	-	-	-	-
B.G.3	Geconcentreerde veranderlijke belasting	-	-	-	-
B.G.4	Sneeuwbelasting	-	-	-	1.00
B.G.2.1	Verdeelde veranderlijke belasting	-	-	1.00	-

FREQUENT BELASTINGSCOMBINATIES (TABEL)

B.G.	Omschrijving	Fr.C.(w1)	Fr.C.1	Fr.C.2
B.G.1	Permanent	1.00	1.00	1.00
B.G.2	Verdeelde veranderlijke belasting	-	-	-
B.G.3	Geconcentreerde veranderlijke belasting	-	-	-
B.G.4	Sneeuwbelasting	-	-	0.20

B.G.2.1 Verdeelde veranderlijke belasting - - -

QUASI-PERMANENT BELASTINGSCOMBINATIES (TABEL)

B.G.	Omschrijving	Qu.C.1
B.G.1	Permanent	1.00
B.G.2	Verdeelde veranderlijke belasting	-
B.G.3	Geconcentreerde veranderlijke belasting	-
B.G.4	Sneeuwbelasting	-
B.G.2.1	Verdeelde veranderlijke belasting	-

UITGANGSPUNTEN VAN DE ANALYSE

Lineaire Elastische Analyse uitgevoerd

AFB. FU.C. MOMENT (MY) OMHULLENDE

Fundamenteel Belastingscombinaties

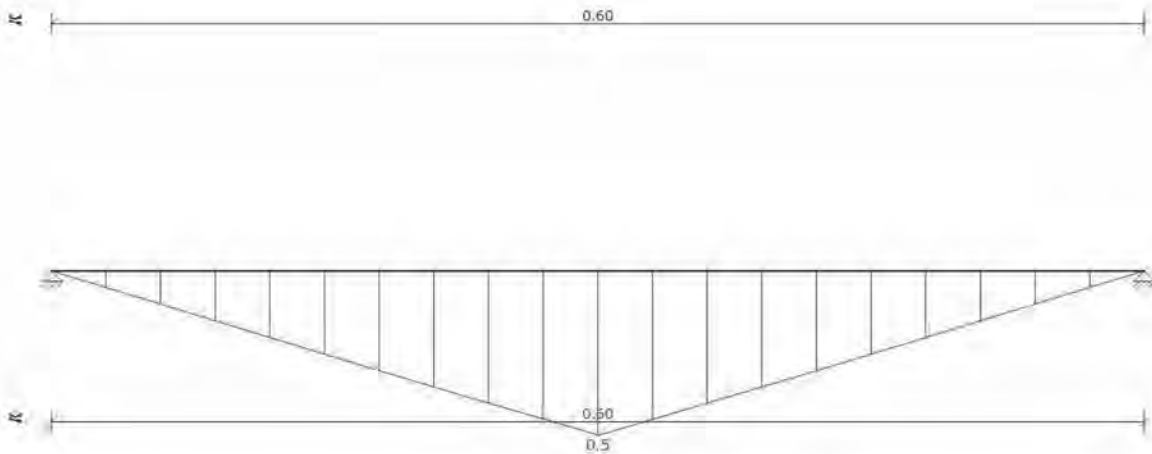

AFB. FU.C. DWARSKRACHT (VZ) OMHULLENDE

Fundamenteel Belastingscombinaties

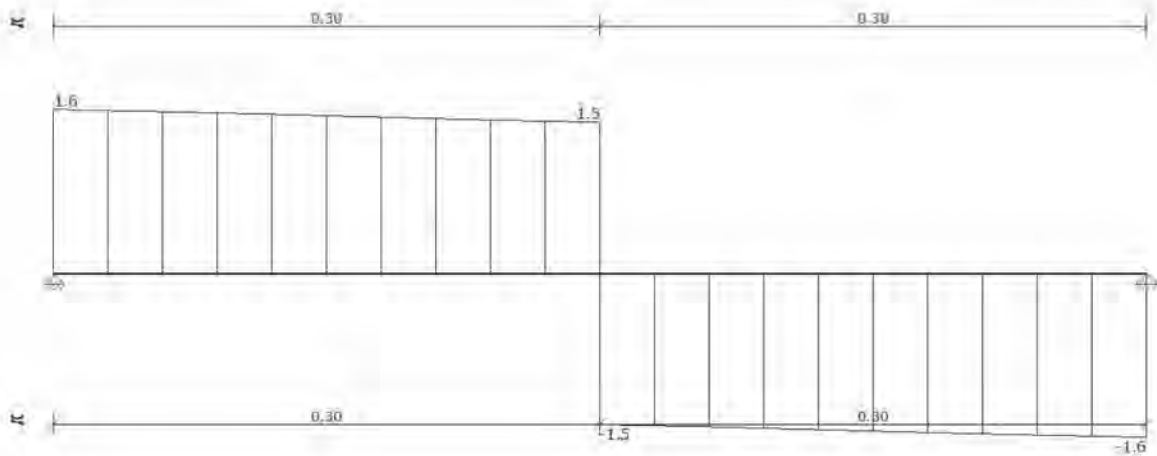

FU.C. STAAFKRACHTEN

Veld	Positie B.G. Ve	Mb	Mmax	xMmax	Me	x-M0	x-M0	Vb
Veld 1	0.000 - 0.600 Fu.C.1	0.00	0.06	0.300	0.00	0.000	0.000	0.40
0.40	-0.40							
	0.000 - 0.600 Fu.C.2	0.00	0.04	0.300	0.00	0.000	0.000	0.28
	0.28 -0.28							
	0.000 - 0.600 Fu.C.3	0.00	0.47	0.300	0.00	0.000	0.000	1.63
	1.63 -1.63							
	0.000 - 0.600 Fu.C.4	0.00	0.02	0.300	0.00	0.000	0.000	0.15
	0.15 -0.15							
-	m -	kNm	kNm	m	kNm	m	m	kN
kN	kN							

AFB. FU.C. OPLEGREACTIES OMHULLENDE

Fundamenteel Belastingscombinaties



FU.C. OPLEGREACTIES

B.C.	Oplegging	Positie	Z	Yr	Z	My
Fu.C.1	O1	0.000	vast	vrij	-0.40	0.00
Fu.C.1	O2	0.600	vast	vrij	-0.40	0.00
	Som Reacties				-0.80	
	Som Lasten				0.80	
Fu.C.2	O1	0.000	vast	vrij	-0.28	0.00
Fu.C.2	O2	0.600	vast	vrij	-0.28	0.00
	Som Reacties				-0.57	

Som Lasten						0.57
Fu.C.3	O1	0.000	vast	vrij	-1.63	0.00
Fu.C.3	O2	0.600	vast	vrij	-1.63	0.00
Som Reacties						-3.26
Som Lasten						3.26
Fu.C.4	O1	0.000	vast	vrij	-0.15	0.00
Fu.C.4	O2	0.600	vast	vrij	-0.15	0.00
Som Reacties						-0.29
Som Lasten						0.29
-	-	m	kN/m	kNm/rad	kN	kNm

B.G. OPLEGREACTIES

B.C.	Oplegging	Positie	Z	Yr	Z	My
B.G.1	O1	0.000	vast	vrij	-0.11	0.00
B.G.1	O2	0.600	vast	vrij	-0.11	0.00
Som Reacties						-0.22
Som Lasten						0.22
B.G.2.1	O1	0.000	vast	vrij	-0.18	0.00
B.G.2.1	O2	0.600	vast	vrij	-0.18	0.00
Som Reacties						-0.36
Som Lasten						0.36
B.G.3	O1	0.000	vast	vrij	-1.00	0.00
B.G.3	O2	0.600	vast	vrij	-1.00	0.00
Som Reacties						-2.00
Som Lasten						2.00
B.G.4	O1	0.000	vast	vrij	-0.10	0.00
B.G.4	O2	0.600	vast	vrij	-0.10	0.00
Som Reacties						-0.20
B.C.	Oplegging	Positie	Z	Yr	Z	My
Som Lasten						0.20
-	-	m	kN/m	kNm/rad	kN	kNm

AFB. KA.C. VERPLAATSINGEN OMHULLENDE

Karakteristiek Belastingcombinaties



KA.C. KNOOPVERPLAATSINGEN

Knoop	B.C.	Z	Yr
K1	Ka.C.(w1)	0.0000	-0.026e-03
	Ka.C.1	0.0000	-0.026e-03
	Ka.C.2	0.0000	-0.070e-03
	Ka.C.3	0.0000	-0.051e-03
K2	Ka.C.(w1)	0.0000	0.026e-03
	Ka.C.1	0.0000	0.026e-03
	Ka.C.2	0.0000	0.070e-03
	Ka.C.3	0.0000	0.051e-03
-	-	m	rad

KA.C. DOORBUIGINGEN

Veld	Positie B.C.	Veld Begin	Z'afst	Veld Z'	Z' glb dist	Veld Eind Z' glb
S1	0.000 - 0.600 Ka.C.(w1)	0,0000	0.300	0,0000	0.300	0.0000 0,0000

S1	0.000 - 0.600	Ka.C.1	0,0000	0.300	0,0000	0.300	0.0000	0,0000
S1	0.000 - 0.600	Ka.C.2	0,0000	0.300	0,0000	0.300	0.0000	0,0000
S1	0.000 - 0.600	Ka.C.3	0,0000	0.300	0,0000	0.300	0.0000	0,0000
-	m	-	m	m	m	m	m	m

AFB. HOUTCONTROLE

C1 - k/ds/bg

SAMENSTELLING CONSTRUCTIEDELEN

Constructiedeel	Staaft/staven
C1	S1

STABILITEITSGEGEVENS

Staaft	Profiel	Y-As (assenstelsel)			Z-As (assenstelsel)		
		Lsys Lkip/Lsys	Methode	Lkip	Lkip/Lsys	Methode	Lkip
C1 - V1 (0.000-0.600)	P2	0.600	Conservatief	0.600	1.00	Conservatief	0.600
1.00	-	geschoord	-	geschoord	-	geschoord	m
-	-	m	-	m	-	-	m

KIPSTEUNENGEGEVENS

Staaft last	Profiel	Begin	Eind	Kipsteunen boven	Kipsteunen onder	Aangrijppunt
C1 - V1 (0.000-0.600)	P2	inklemming	inklemming			Neutraal
-	-	Volledig vast	Volledig vast	m	m	-

DOORBUIGINGGEGEVENS

Staaft w;2+w;3	Constr.type	Toetsingstype	Zeeg Y'	Zeeg Z'	Zeegvorm	w;max
C1 - V1 (0.000-0.600)	Dak	Algemeen	0	0	Parabolisch	L/250
L/250	-	-	mm	mm	-	-

UNITY CHECK

Label	Toetsing	Combinatie	Artikel	UC max
C1	Doorsnede	Fu.C.3	NEN-EN1995-1-1#6.1.6 (6.11)	0.20
	Kip	Fu.C.3	NEN-EN1995-1-1#6.3.3 (6.33)	0.20
	Doorbuiging	Ka.C.2	NEN-EN1995#7.2 NEN-EN1990#A1.4.3(4)	0.01

8.13 Bijlage uitraai MatrixFrame berekening Pos 13

AFB. GEOMETRIE LIGGER

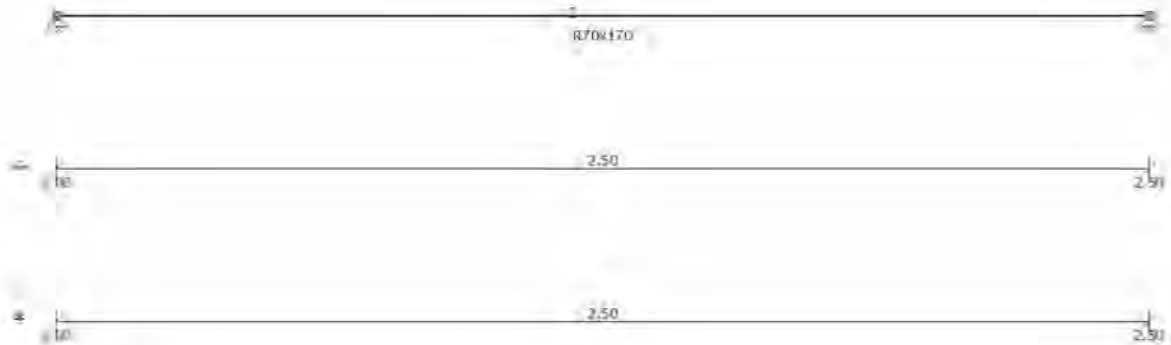

BALKGEOMETRIE

Positie	Profielnaam	5.1.2.e	Traagheidsmoment	Materiaal	E-Modulus	Uitzettingcoeff
Gewicht						
0.000 - L(2.500)	R70x170	0	2.8659e-05	C24	1.1000e+07	50.0000e-07
0.05						
m -		°	m4 -		kN/m2	C°m
kN/m						

PROFIELVORMEN

Profiel	Verl. h.	hB	hE	tf	tw	tf2	B	bL	bR	Raatl.
Hoogte										
P6	Nee	0,170	0,170	0,0000	0,0000	0,0000	0,070	0,000	0,000	Nee 0,000
-	-	m	m	m	m	m	m	m	m	m - m

MATERIALEN

Materiaalnaam	Poison	Dichtheid	E-Modulus	Uitzettingcoeff
C24	0.40	4.20	1.1000e+07	50.0000e-07
-	-	kN/m3	kN/m2	C°m

OPLEGGINGEN

Oplegging	Positie	Z	Yr
O1	0.000	vast	vrij
O2	L(2.500)	vast	vrij
-	m	kN/m	kNm/rad

BELASTINGSGEVALLEN TYPEN

Oplegg.	Staven	5.1.2.e	Gunstig/Ong.	Element	5.1.2.e	Psi0	Psi1	Cprob
Psi2	UGT/GGT							
B.G.1	Permanent	Permanent	-		N.v.t.	N.v.t.		
B.G.2	Verdeelde veranderlijke belasting	Verdeelde veranderlijke belasting	-	Cat. H) Ontoegankelijke daken	1	1		
B.G.3	Geconcentreerde veranderlijke belasting	Geconcentreerde veranderlijke belasting	-	Cat. H) Ontoegankelijke daken		N.v.t.	N.v.t.	
B.G.4	Sneeuwbelasting	Sneeuwbelasting	-		N.v.t.	N.v.t.	0.20	
1.00/1.00								
B.G.2.1	Verdeelde veranderlijke	Verdeelde	-	Cat. H) Ontoegankelijke	1	1		

1.00/1.00
belasting

veranderlijke
belasting

daken

AFB. LASTEN B.G.1 PERMANENT

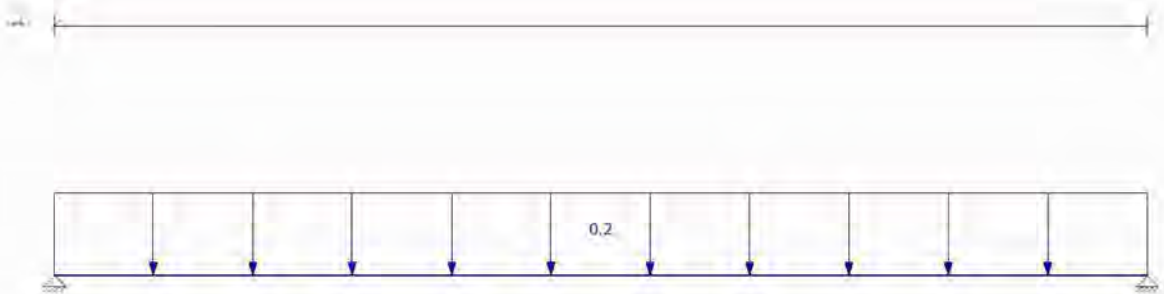

AFB. LASTEN B.G.2 VERDEELDE VERANDERLIJKE BELASTING

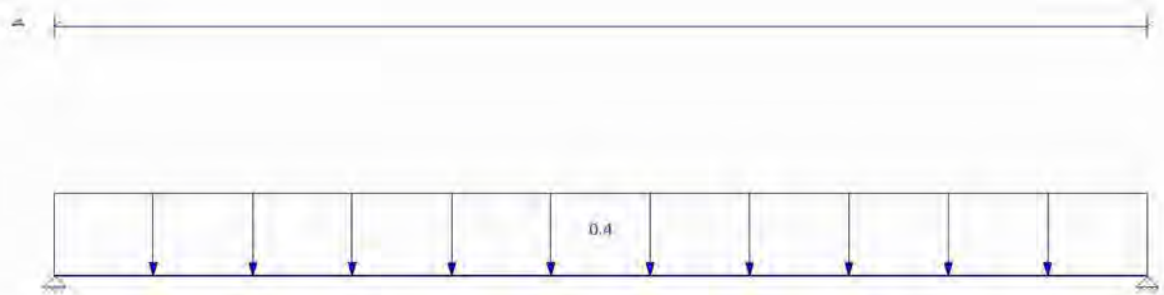

AFB. LASTEN B.G.3 GECONCENTREERDE VERANDERLIJKE BELASTING

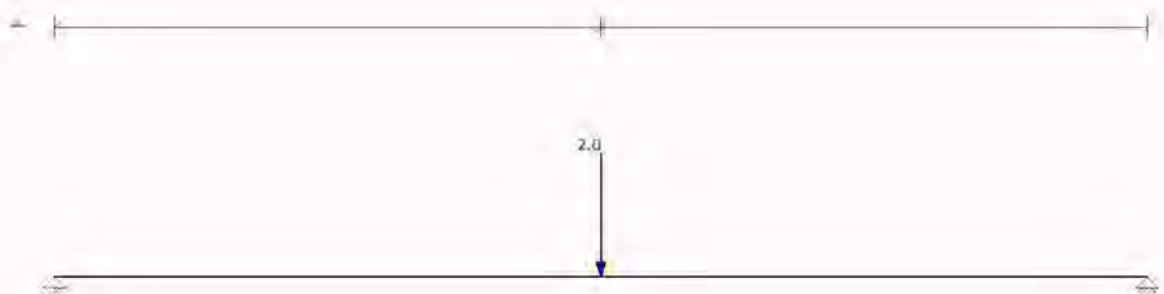

AFB. LASTEN B.G.4 SNEEUWBELASTING

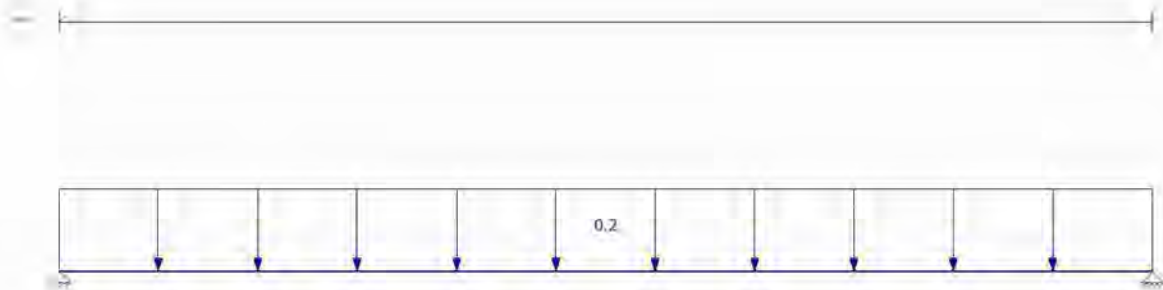

AFB. LASTEN B.G.2.1 VERDEELDE VERANDERLIJKE BELASTING

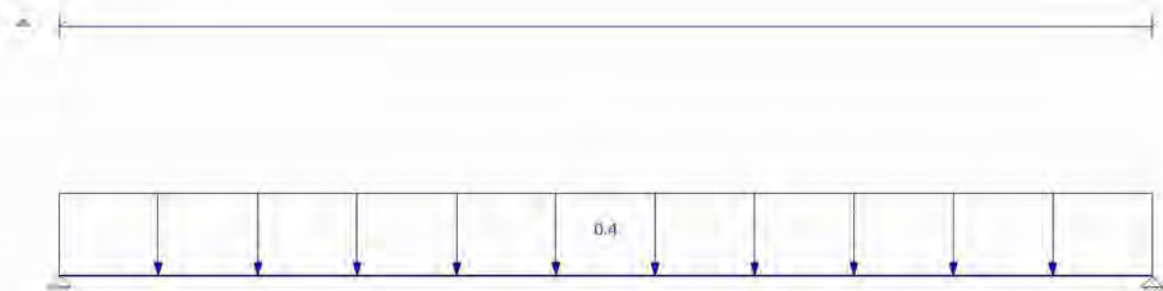

FUNDAMENTEEL BELASTINGSCOMBINATIES (TABEL)

B.G.	Omschrijving	Fu.C.1	Fu.C.2	Fu.C.3	Fu.C.4
B.G.1	Permanent	1.20	1.20	1.20	1.35
B.G.2	Verdeelde veranderlijke belasting	-	-	-	-
B.G.3	Geconcentreerde veranderlijke belasting	-	-	1.50	-
B.G.4	Sneeuwbelasting	-	1.50	-	-
B.G.2.1	Verdeelde veranderlijke belasting	1.50	-	-	-

KARAKTERISTIEK BELASTINGSCOMBINATIES (TABEL)

B.G.	Omschrijving	Ka.C.(w1)	Ka.C.1	Ka.C.2	Ka.C.3
B.G.1	Permanent	1.00	1.00	1.00	1.00
B.G.2	Verdeelde veranderlijke belasting	-	-	-	-
B.G.3	Geconcentreerde veranderlijke belasting	-	-	-	-
B.G.4	Sneeuwbelasting	-	-	-	1.00
B.G.2.1	Verdeelde veranderlijke belasting	-	-	1.00	-

FREQUENT BELASTINGSCOMBINATIES (TABEL)

B.G.	Omschrijving	Fr.C.(w1)	Fr.C.1	Fr.C.2
B.G.1	Permanent	1.00	1.00	1.00
B.G.2	Verdeelde veranderlijke belasting	-	-	-
B.G.3	Geconcentreerde veranderlijke belasting	-	-	-
B.G.4	Sneeuwbelasting	-	-	0.20

B.G.2.1 Verdeelde veranderlijke belasting - - -

QUASI-PERMANENT BELASTINGSCOMBINATIES (TABEL)

B.G.	Omschrijving	Qu.C.1
B.G.1	Permanent	1.00
B.G.2	Verdeelde veranderlijke belasting	-
B.G.3	Geconcentreerde veranderlijke belasting	-
B.G.4	Sneeuwbelasting	-
B.G.2.1	Verdeelde veranderlijke belasting	-

UITGANGSPUNTEN VAN DE ANALYSE

Lineaire Elastische Analyse uitgevoerd

AFB. FU.C. MOMENT (MY) OMHULLENDE

Fundamenteel Belastingscombinaties

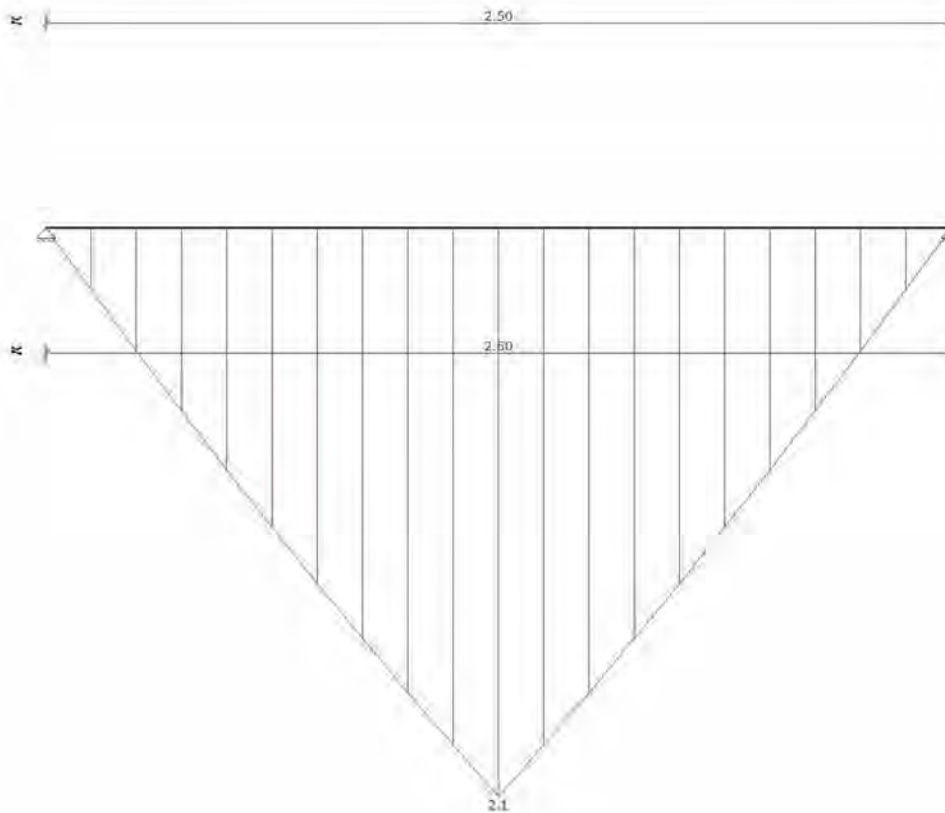

AFB. FU.C. DWARSKRACHT (VZ) OMHULLENDE

Fundamenteel Belastingscombinaties

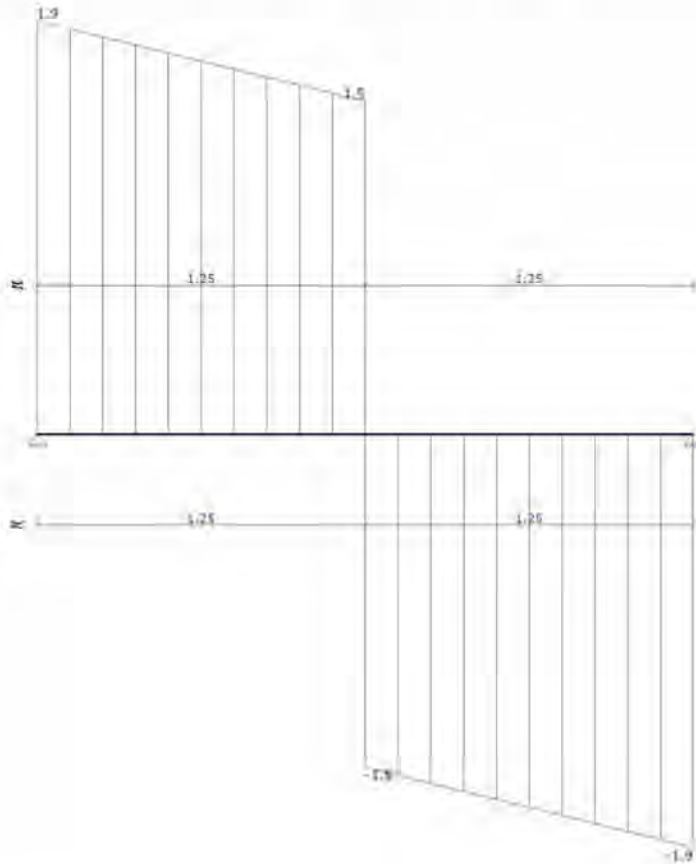

FU.C. STAAFKRACHTEN

Veld	Positie B.G.	Mb	Mmax	xMmax	Me	x-M0	x-M0	Vb
Vmax	Ve							
Veld 1	0.000 - 2.500 Fu.C.1	0.00	0.69	1.250	0.00	0.000	0.000	1.11
1.11	-1.11							
	0.000 - 2.500 Fu.C.2	0.00	0.48	1.250	0.00	0.000	0.000	0.77
	0.77 -0.77							
	0.000 - 2.500 Fu.C.3	0.00	2.10	1.250	0.00	0.000	0.000	1.86
	1.86 -1.86							
	0.000 - 2.500 Fu.C.4	0.00	0.25	1.250	0.00	0.000	0.000	0.41
	0.41 -0.41							
-	m -	kNm	kNm	m	kNm	m	m	kN
kN	kN							

AFB. FU.C. OPLEGREACTIES OMHULLENDE

Fundamenteel Belastingscombinaties



FU.C. OPLEGREACTIES

B.C.	Oplegging	Positie	Z	Yr	Z	My
Fu.C.1	O1	0.000	vast	vrij	-1.11	0.00
Fu.C.1	O2	2.500	vast	vrij	-1.11	0.00
	Som Reacties				-2.22	
	Som Lasten				2.22	
Fu.C.2	O1	0.000	vast	vrij	-0.77	0.00
Fu.C.2	O2	2.500	vast	vrij	-0.77	0.00
	Som Reacties				-1.55	
	Som Lasten				1.55	
Fu.C.3	O1	0.000	vast	vrij	-1.86	0.00
Fu.C.3	O2	2.500	vast	vrij	-1.86	0.00
	Som Reacties				-3.72	
	Som Lasten				3.72	
Fu.C.4	O1	0.000	vast	vrij	-0.41	0.00
Fu.C.4	O2	2.500	vast	vrij	-0.41	0.00
	Som Reacties				-0.81	
	Som Lasten				0.81	
-	-	m	kN/m	kNm/rad	kN	kNm

B.G. OPLEGREACTIES

B.C.	Oplegging	Positie	Z	Yr	Z	My
B.G.1	O1	0.000	vast	vrij	-0.30	0.00
B.G.1	O2	2.500	vast	vrij	-0.30	0.00
	Som Reacties				-0.60	
	Som Lasten				0.60	
B.G.2.1	O1	0.000	vast	vrij	-0.50	0.00
B.G.2.1	O2	2.500	vast	vrij	-0.50	0.00
	Som Reacties				-1.00	
	Som Lasten				1.00	
B.G.3	O1	0.000	vast	vrij	-1.00	0.00
B.G.3	O2	2.500	vast	vrij	-1.00	0.00
	Som Reacties				-2.00	
	Som Lasten				2.00	
B.G.4	O1	0.000	vast	vrij	-0.28	0.00
B.G.4	O2	2.500	vast	vrij	-0.28	0.00
	Som Reacties				-0.55	
	Som Lasten				0.55	
-	-	m	kN/m	kNm/rad	kN	kNm

AFB. KA.C. VERPLAATSINGEN OMHULLENDE

Karakteristiek Belastingcombinaties



KA.C. KNOOPVERPLAATSINGEN

Knoop	B.C.	Z	Yr
K1	Ka.C.(w1)	0.0000	-0.496e-03
	Ka.C.1	0.0000	-0.496e-03
	Ka.C.2	0.0000	-1.322e-03
	Ka.C.3	0.0000	-0.950e-03
K2	Ka.C.(w1)	0.0000	0.496e-03
	Ka.C.1	0.0000	0.496e-03
	Ka.C.2	0.0000	1.322e-03
	Ka.C.3	0.0000	0.950e-03
-	-	m	rad

KA.C. DOORBUIGINGEN

Veld	Positie B.C.	Veld Begin	Veld		Veld Eind	
			Z'afst	Z' Z' glb dist	Z' glb	Z' glb
S1	0.000 - 2.500 Ka.C.(w1)	0,0000	1.250	0,0004	1.250	0.0004 0,0000
S1	0.000 - 2.500 Ka.C.1	0,0000	1.250	0,0004	1.250	0.0004 0,0000
S1	0.000 - 2.500 Ka.C.2	0,0000	1.250	0,0010	1.250	0.0010 0,0000
S1	0.000 - 2.500 Ka.C.3	0,0000	1.250	0,0007	1.250	0.0007 0,0000
-	m -	m	m	m	m	m m

AFB. HOUTCONTROLE

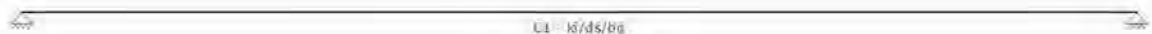

SAMENSTELLING CONSTRUCTIEDELEN

Constructiedeel	StAAF/staven
C1	S1

STABILITEITSGEGEVENS

StAAF	Profiel	Y-As (assenstelsel)			Z-As(assenstelsel)	
		Lsys Methode Lkip/Lsys	Lkip	Lkip/Lsys	Methode	Lkip
C1 - V1 (0.000-2.500)	P6	2.500 Conservatief	2.500	1.00	Conservatief	2.500

1.00
 - - geschoord m - m - geschoord m -

KIPSTEUNENGEGEVENS

StAAF last	Profiel	Begin	Eind	Kipsteunen boven	Kipsteunen onder	Aangrijppunt
C1 - V1 (0.000-2.500)	P6	in-klemming	in-klemming			Neutraal
-	-	Volledig vast	Volledig vast	m	m	-

DOORBUIGINGSGEGEVENS

StAAF w;2+w;3	Constr.type	Toetsingstype	Zeeg Y'	Zeeg Z'	Zeegvorm	w;max
C1 - V1 (0.000-2.500) L/250	Dak	Algemeen	0	0	Parabolisch	L/250
-	-	-	mm	mm	-	-

UNITY CHECK

Label	Toetsing	Combinatie	Artikel	UC max
C1	Doorsnede	Fu.C.3	NEN-EN1995-1-1#6.1.6 (6.11)	0.42
	Kip	Fu.C.3	NEN-EN1995-1-1#6.3.3 (6.33)	0.42
	Doorbuiging	Ka.C.2	NEN-EN1995#7.2 NEN-EN1990#A1.4.3(4)	0.13

8.14 Bijlage uitraai MatrixFrame berekening Pos 14

AFB. GEOMETRIE RAAMWERK



STAVEN

Staf	Knoop B	Knoop E	X-B	Z-B	X-E	Z-E	Lengte	Profiel
S1	K1	K2	0.000	0.000	0.000	-2.500	2.500	P1
0.000 - L(2.500)								
-	-	-	m	m	m	m	m	-

PROFIELEN

Profiel	Profielnaam	Oppervlakte	Iy	Materiaal	5.1.2.e
P1	R38x120	4.5600e-03	5.4720e-06	C24	0.0
-	-	m ²	m ⁴	-	°

PROFIELVORMEN

Profiel	Verl. h.	hB	hE	tf	tw	tf2	B	bL	bR	Raatl.
P1	Nee	0,120	0,120	0,0000	0,0000	0,0000	0,038	0,000	0,000	Nee 0,000
-	-	m	m	m	m	m	m	m	m	m

MATERIALEN

Materiaal	Dichtheid	E-Modulus	Uitzettingcoeff
C24	4.20	1.1000e+07	50.0000e-07
-	kN/m ³	kN/m ²	C°m

OPLEGGINGEN

Oplegging	Object	Positie	Z	Yr	HoekYr
O1	K1	0.000	vast	vrij	0
O2	K2	0.000	vast	vrij	0
-	-	m	kN/m	kN/m	rad

BELASTINGSGEVALLEN TYPEN

Oplegg.	Staven	5.1.2.e	Gunstig/Ong.	Element	5.1.2.e	Psi0	Psi1	Cprob
B.G.1	Permanent	Permanent	-		N.v.t.	N.v.t.		
B.G.2	Geconcentreerde	Geconcentreerde	-	Cat. A) Vloeren	N.v.t.	N.v.t.	0.40	0.50
0.30	veranderlijke belasting	veranderlijke belasting						
B.G.3	Windbelasting	Windbelasting	-		N.v.t.	N.v.t.	0.20	
1.00/1.00								
B.G.4	Kniklengte (Assymetrisch)	Kniklengte			N.v.t.	N.v.t.		
B.G.5	Kniklengte (Symmetrisch)	Kniklengte			N.v.t.	N.v.t.		

FUNDAMENTEEL BELASTINGSCOMBINATIES (TABEL)

B.G.	Omschrijving	Fu.C.1	Fu.C.2	Fu.C.3	Fu.C.4
B.G.1	Permanent	1.20	1.20	1.35	1.35
B.G.2	Geconcentreerde veranderlijke belasting	-	1.50	-	0.60
B.G.3	Windbelasting	1.50	-	-	-
B.G.4	Kniklengte (Assymetrisch)	-	-	-	-
B.G.5	Kniklengte (Symmetrisch)	-	-	-	-

KARAKTERISTIEK BELASTINGSCOMBINATIES (TABEL)

B.G.	Omschrijving	Ka.C.(w1)	Ka.C.1	Ka.C.2
------	--------------	-----------	--------	--------

B.G.1	Permanent	1.00	1.00	1.00
B.G.2	Geconcentreerde veranderlijke belasting	-	-	-
B.G.3	Windbelasting	-	-	1.00
B.G.4	Kniklengte (Assymetrisch)	-	-	-
B.G.5	Kniklengte (Symmetrisch)	-	-	-

FREQUENT BELASTINGSCOMBINATIES (TABEL)

B.G.	Omschrijving	Fr.C.(w1)	Fr.C.1
B.G.1	Permanent	1.00	1.00
B.G.2	Geconcentreerde veranderlijke belasting	-	-
B.G.3	Windbelasting	-	0.20
B.G.4	Kniklengte (Assymetrisch)	-	-
B.G.5	Kniklengte (Symmetrisch)	-	-

QUASI-PERMANENT BELASTINGSCOMBINATIES (TABEL)

B.G.	Omschrijving	Qu.C.1
B.G.1	Permanent	1.00
B.G.2	Geconcentreerde veranderlijke belasting	-
B.G.3	Windbelasting	-
B.G.4	Kniklengte (Assymetrisch)	-
B.G.5	Kniklengte (Symmetrisch)	-

UITGANGSPUNTEN VAN DE ANALYSE

Lineaire Elastische Analyse uitgevoerd

AFB. HOUTCONTROLE



SAMENSTELLING CONSTRUCTIEDELEN

Constructiedeel	Staal/staven
C1	S1

STABILITEITSGEGEVENS

Staal	Profiel	Y-As (assenstelsel)			Z-As(assenstelsel)		
		Lsys Lkip/Lsys	Methode	Lkip	Lkip/Lsys	Methode	Lkip
C1 - V1 (0.000-2.500) 0.10	P1	2.500	Geschoord	2.406	0,96	Handmatige Invoer	0.250
-	-	m	-	m	-	-	m

KIPSTEUNENGEDEVENS

Staal last	Profiel	Begin	Eind	Kipsteunen boven	Kipsteunen onder	Aangrijppunt
C1 - V1 (0.000-2.500)	P1	inklemming	inklemming			Neutraal
-	-	Volledig vast	Volledig vast	m	m	-

DOORBUIGINGGEGEVENS

Staal w;2+w;3	Constr.type	Toetsingstype	Zeeg Y'	Zeeg Z'	Zeegvorm	w;max
C1 - V1 (0.000-2.500)	Kolom	1 bouwlaag			Parabolisch	H/300
-	-	-	mm	mm	-	N/B

AFB. HOUT UC DIAGRAM

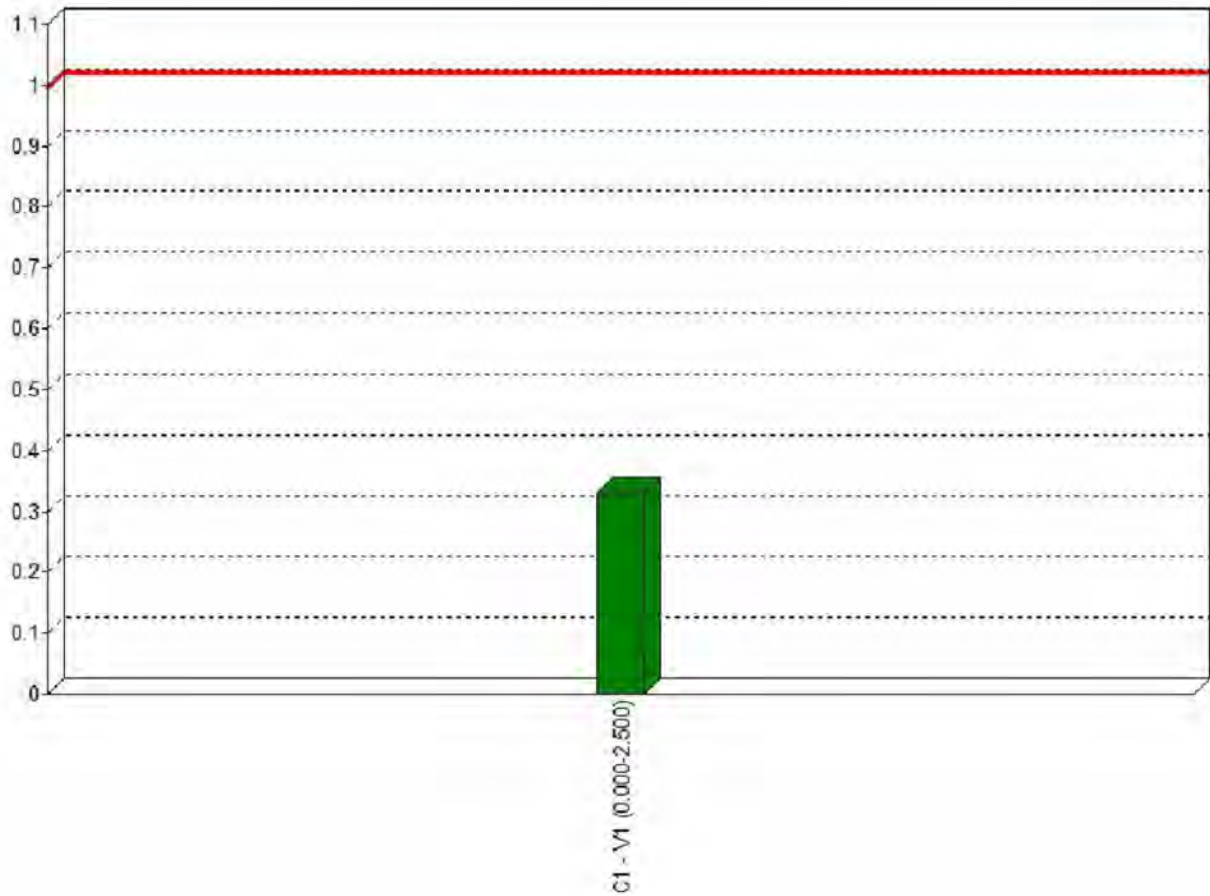

UNITY CHECK

Label	Toetsing	Combinatie	Artikel	UC max
C1	Doorsnede	Fu.C.1	NEN-EN1995-1-1#6.2.4 (6.19)	0.28
	Kip	Fu.C.1	NEN-EN1995-1-1#6.3.3 (6.35)	0.13
	Stabiliteit	Fu.C.1	NEN-EN1995-1-1#6.3.2 (6.23)	0.33

8.15 Bijlage uitraai MatrixFrame berekening Pos 15

AFB. GEOMETRIE 1 STAVEN EN KNOPEN

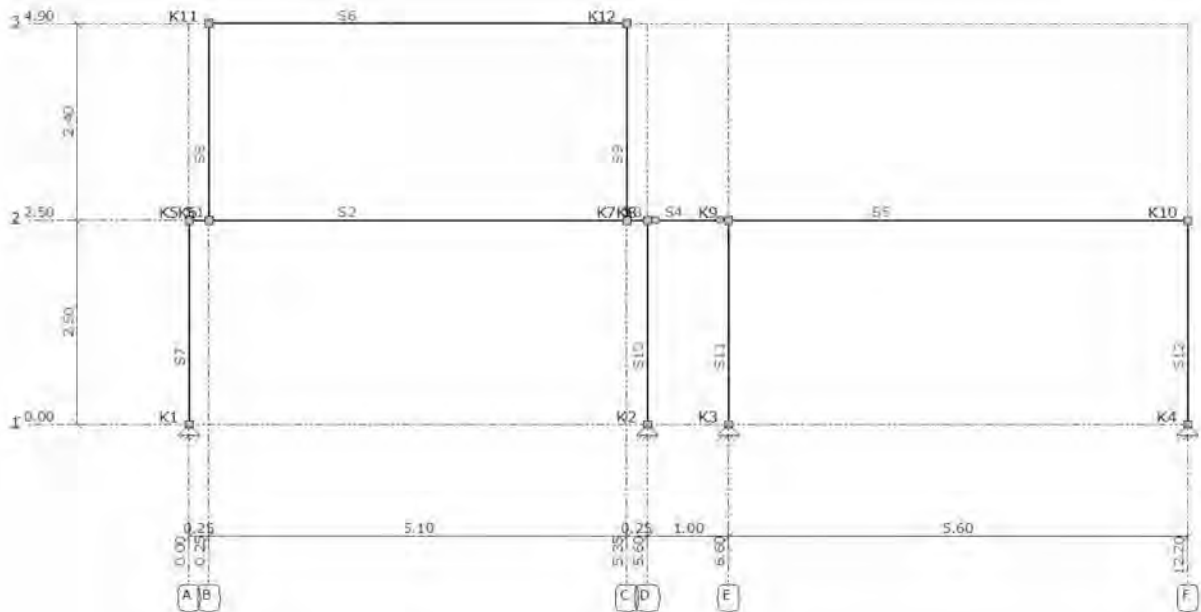

STAVEN

Staf Positie	Knoop B	Knoop E	X-B	Z-B	X-E	Z-E	Lengte Profiel
S1 0,000 - L(0,250)	K5	K6	0,000	-2,500	0,250	-2,500	0,250 P1
S2 0,000 - L(5,100)	K6	K7	0,250	-2,500	5,350	-2,500	5,100 P1
S3 0,000 - L(0,250)	K7	K8	5,350	-2,500	5,600	-2,500	0,250 P1
S4 0,000 - L(1,000)	K8	K9	5,600	-2,500	6,600	-2,500	1,000 P5
S5 0,000 - L(5,600)	K9	K10	6,600	-2,500	12,200	-2,500	5,600 P1
S6 0,000 - L(5,100)	K11	K12	0,250	-4,900	5,350	-4,900	5,100 P2
S7 0,000 - L(2,500)	K1	K5	0,000	0,000	0,000	-2,500	2,500 P3
S8 0,000 - L(2,400)	K6	K11	0,250	-2,500	0,250	-4,900	2,400 P4
S9 0,000 - L(2,400)	K7	K12	5,350	-2,500	5,350	-4,900	2,400 P4
S10 0,000 - L(2,500)	K2	K8	5,600	0,000	5,600	-2,500	2,500 P3
S11 0,000 - L(2,500)	K3	K9	6,600	0,000	6,600	-2,500	2,500 P3
S12 0,000 - L(2,500)	K4	K10	12,200	0,000	12,200	-2,500	2,500 P3
-	-	-	m	m	m	m	m -

SCHARNIEREN

Staf	Positie	Scharnier
------	---------	-----------

	Oplegg.			Yr
S1	0,000 A2	Vast	Vast	Vast
	L(0,250) A2	Vast	Vast	Vast
S2	0,000 A2	Vast	Vast	Vast
	L(5,100) A2	Vast	Vast	Vast
S3	0,000 A2	Vast	Vast	Vast
	L(0,250) A2	Vast	Vast	Vast
S4	0,000 A1	Vast	Vast	Vrij

Staaft	Positie	Oplegg.	Scharnier	Yr
S4	L(1,000) A1		Vast	Vast
-	m -		kN/m	kN/m
				kNm/rad

AFB. GEOMETRIE 2 STAVEN EN KNOPEN



PROFIELEN

Profiel	Profielnaam	Oppervlakte	Iy	Materiaal	5.1.2.e
P1	HE200A	5.3831e-03	3.6922e-05	S235	0,0
P2	HE180A	4.5251e-03	2.5103e-05	S235	0,0
P3	HE140B	4.2956e-03	1.5092e-05	S235	0,0
P4	HE140B	4.2956e-03	1.5092e-05	S235	0,0
P5	C100	7.8540e-03	4.9087e-06	S235	0,0
-	-	m2	m4 -		⚡

PROFIELVORMEN

Profiel	Verl. h.	hB	hE	tf	tw	tf2	B	bL	bR	Raatl.
P5	Nee	0,100	0,100	0,0000	0,0000	0,0000	0,100	0,000	0,000	Nee 0,000
-	-	m	m	m	m	m	m	m	m -	m

MATERIALEN

Materiaal	Dichtheid	E-Modulus	Uitzettingcoeff
S235	78.50	2.1000e+08	12.0000e-06
-	kN/m3	kN/m2	C⊕m

OPLEGGINGEN

Oplegging	Object	Positie	Z	Yr	HoekYr
O1	K1	0,000	Vast	Vast	Vrij
					0

O2	K2	0,000	Vast	Vast	Vrij	0
O3	K3	0,000	Vast	Vast	Vrij	0
O4	K4	0,000	Vast	Vast	Vrij	0
-	-	m	kN/m	kN/m	kNm/rad	⚡

BELASTINGSGEVALLEN TYPEN

Oplegg.	Staven	5.1.2.e	Gunstig/Ong. Element	5.1.2.e	Cprob		
Psi2	UGT/GGT				Psi0	Psi1	
B.G.1	Permanent	Permanent	-	N.v.t. N.v.t.			
B.G.2	Verdeelde veranderlijke 1,00/1,00 belasting	Verdeelde veranderlijke belasting	-	Cat. H) Ontoegankelijke daken	1	1	
B.G.3 0.30	Verdeelde veranderlijke 1,00/1,00 belasting	Verdeelde veranderlijke belasting	-	Cat. A) Vloeren	2	1	0.40 0.50
B.G.4	Wind links 1,00/1,00	Windbelasting	-	N.v.t. N.v.t.		0.20	
B.G.5	Wind rechts 1,00/1,00	Windbelasting	-	N.v.t. N.v.t.		0.20	
B.G.6	Kniklengte (Assymetrisch)	Kniklengte		N.v.t. N.v.t.			
B.G.7	Kniklengte (Symmetrisch)	Kniklengte		N.v.t. N.v.t.			

AFB. LASTEN B.G.1 PERMANENT

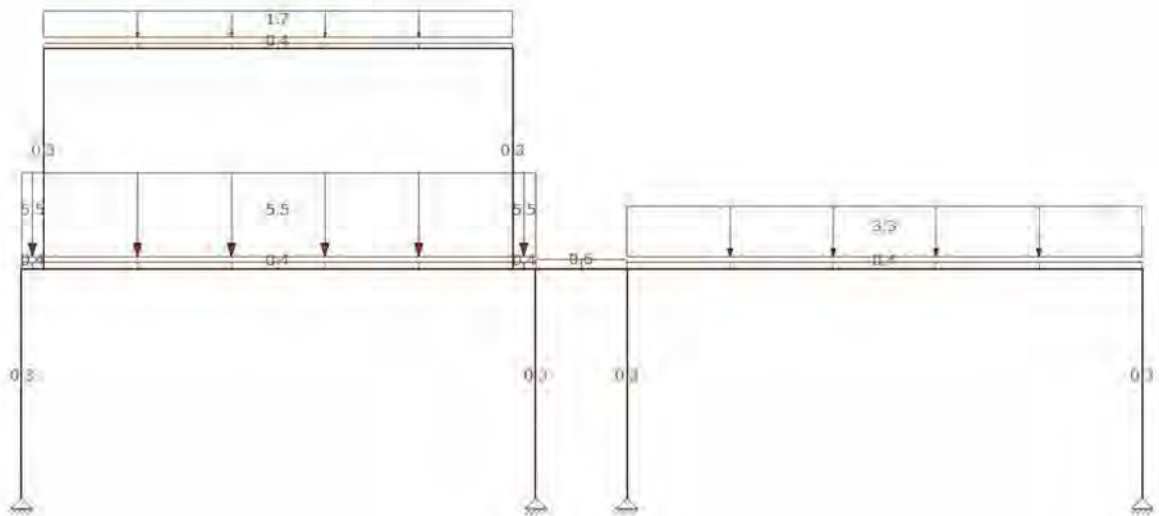

AFB. LASTEN B.G.2 VERDEELDE VERANDERLIJKE BELASTING

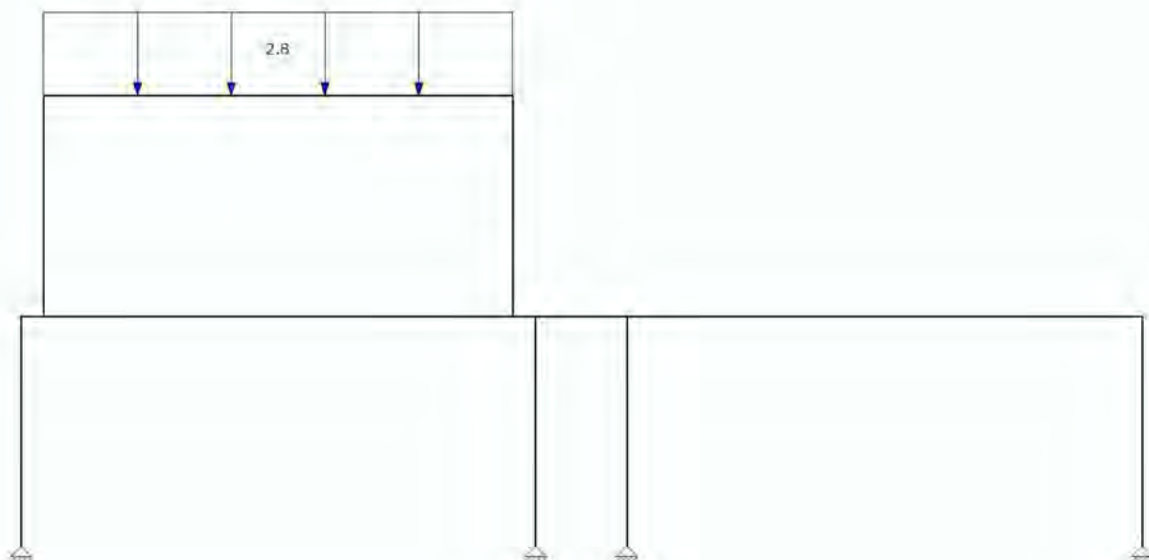

AFB. LASTEN B.G.3 VERDEELDE VERANDERLIJKE BELASTING

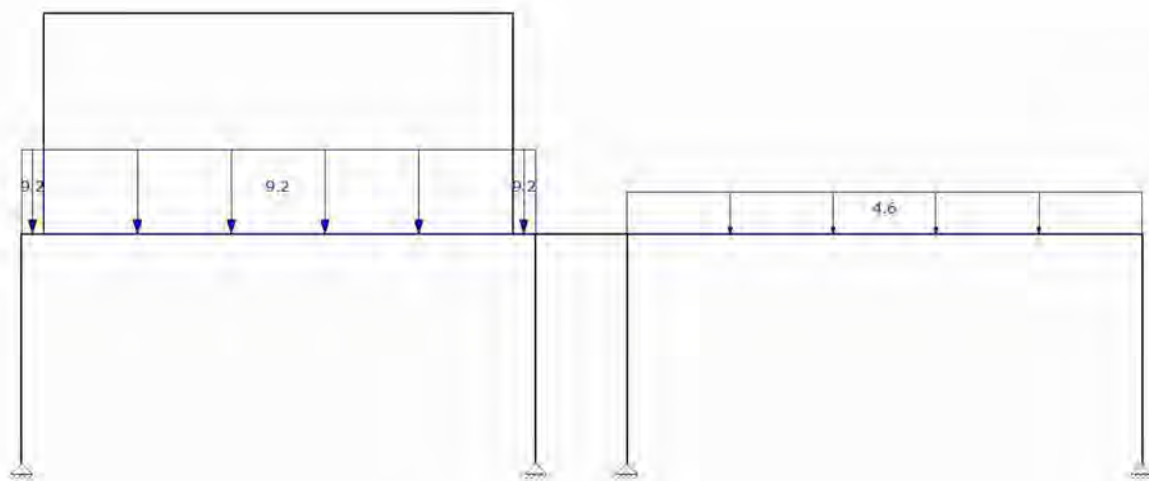

AFB. LASTEN B.G.4 WIND LINKS

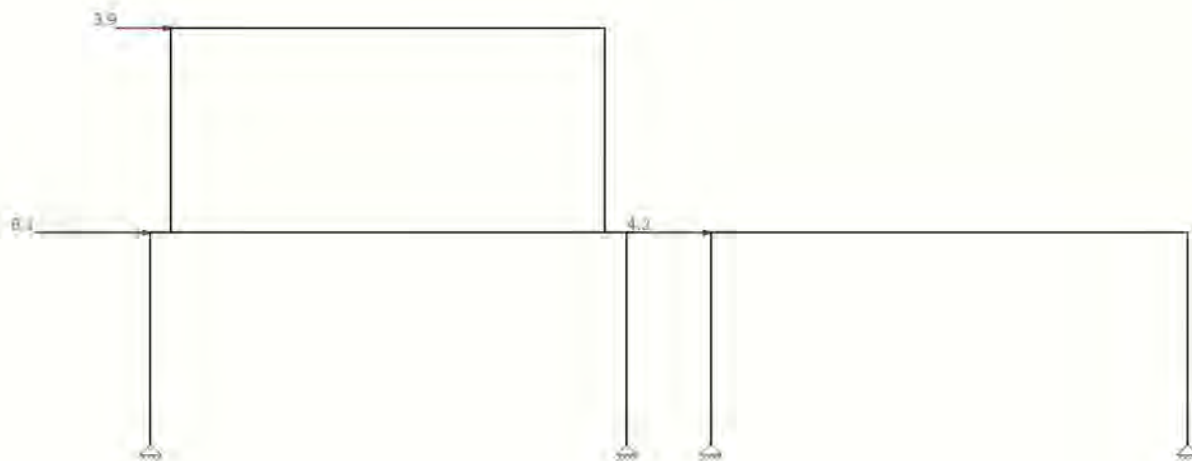

AFB. LASTEN B.G.5 WIND RECHTS

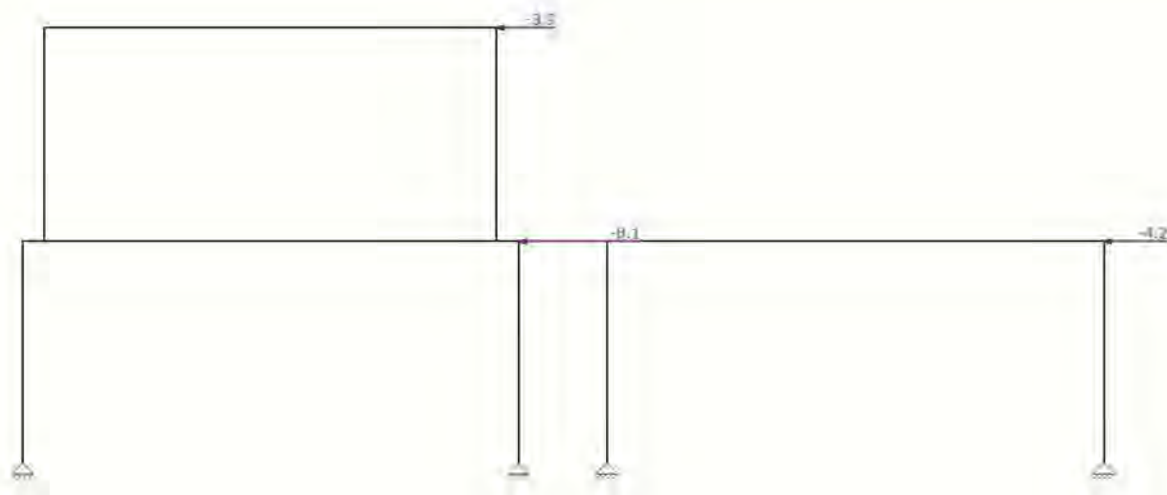

AFB. LASTEN B.G.6 KNIKLENGTE (ASSYMETRISCH)

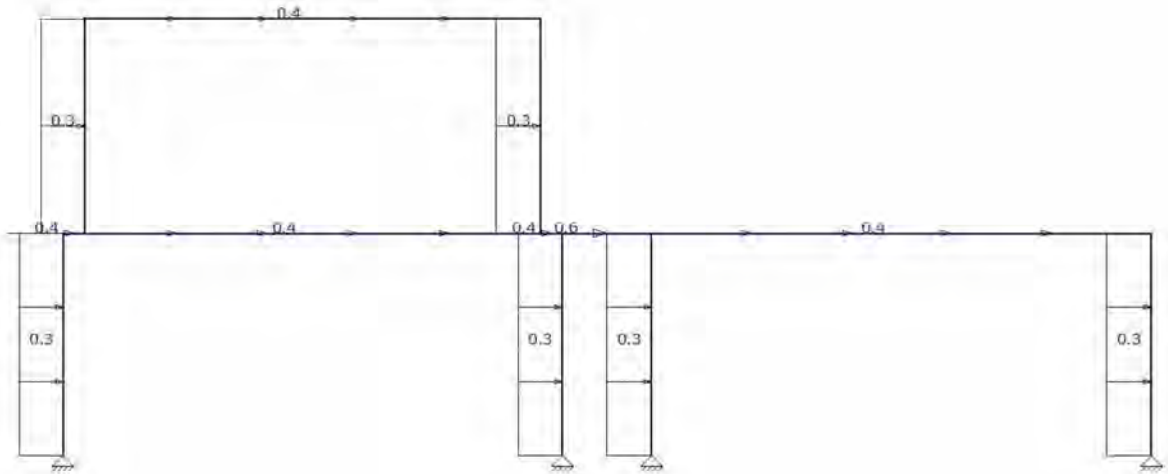

AFB. LASTEN B.G.7 KNIKLENGTE (SYMMETRISCH)

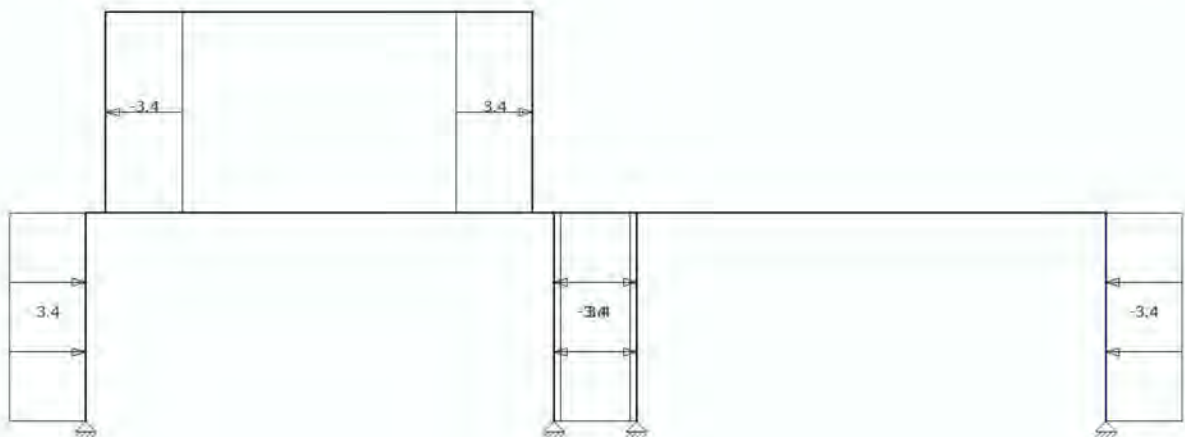

FUNDAMENTEEL BELASTINGSCOMBINATIES (TABEL)

B.G.	Omschrijving	Fu.C.1	Fu.C.2	Fu.C.3	Fu.C.4	Fu.C.5
B.G.1	Permanent	1.20	1.20	1.20	1.20	1.35
B.G.2	Verdeelde veranderlijke belasting	1.50	-	-	-	-
B.G.3	Verdeelde veranderlijke belasting	0.60	1.50	0.60	0.60	0.60
B.G.4	Wind links	-	-	1.50	-	-
B.G.5	Wind rechts	-	-	-	1.50	-
B.G.6	Kniklengte (Assymetrisch)	-	-	-	-	-
B.G.7	Kniklengte (Symmetrisch)	-	-	-	-	-

KARAKTERISTIEK BELASTINGSCOMBINATIES (TABEL)

B.G.	Omschrijving	Ka.C.(w1)	Ka.C.1	Ka.C.2	Ka.C.3	Ka.C.4	Ka.C.5
B.G.1	Permanent	1,00	1,00	1,00	1,00	1,00	1,00
B.G.2	Verdeelde veranderlijke belasting	-	-	1,00	-	-	-
B.G.3	Verdeelde veranderlijke belasting	-	0,40	0,40	1,00	0,40	0,40
B.G.4	Wind links	-	-	-	1,00	-	-
B.G.5	Wind rechts	-	-	-	-	1,00	-
B.G.6	Kniklengte (Assymetrisch)	-	-	-	-	-	-
B.G.7	Kniklengte (Symmetrisch)	-	-	-	-	-	-

FREQUENT BELASTINGSCOMBINATIES (TABEL)

B.G.	Omschrijving	Fr.C.(w1)	Fr.C.1	Fr.C.2	Fr.C.3	Fr.C.4
B.G.1	Permanent	1,00	1,00	1,00	1,00	1,00
B.G.2	Verdeelde veranderlijke belasting	-	-	-	-	-
B.G.3	Verdeelde veranderlijke belasting	-	0,30	0,50	0,30	0,30
B.G.4	Wind links	-	-	-	0,20	-
B.G.5	Wind rechts	-	-	-	-	0,20
B.G.6	Kniklengte (Assymetrisch)	-	-	-	-	-
B.G.7	Kniklengte (Symmetrisch)	-	-	-	-	-

QUASI-PERMANENT BELASTINGSCOMBINATIES (TABEL)

B.G.	Omschrijving	Qu.C.1
B.G.1	Permanent	1,00
B.G.2	Verdeelde veranderlijke belasting	-
B.G.3	Verdeelde veranderlijke belasting	0,30
B.G.4	Wind links	-
B.G.5	Wind rechts	-
B.G.6	Kniklengte (Assymetrisch)	-
B.G.7	Kniklengte (Symmetrisch)	-

UITGANGSPUNTEN VAN DE ANALYSE

Lineaire Elastische Analyse uitgevoerd

AFB. FU.C. MOMENT (MY) OMHULLENDE

Fundamenteel Belastingscombinaties

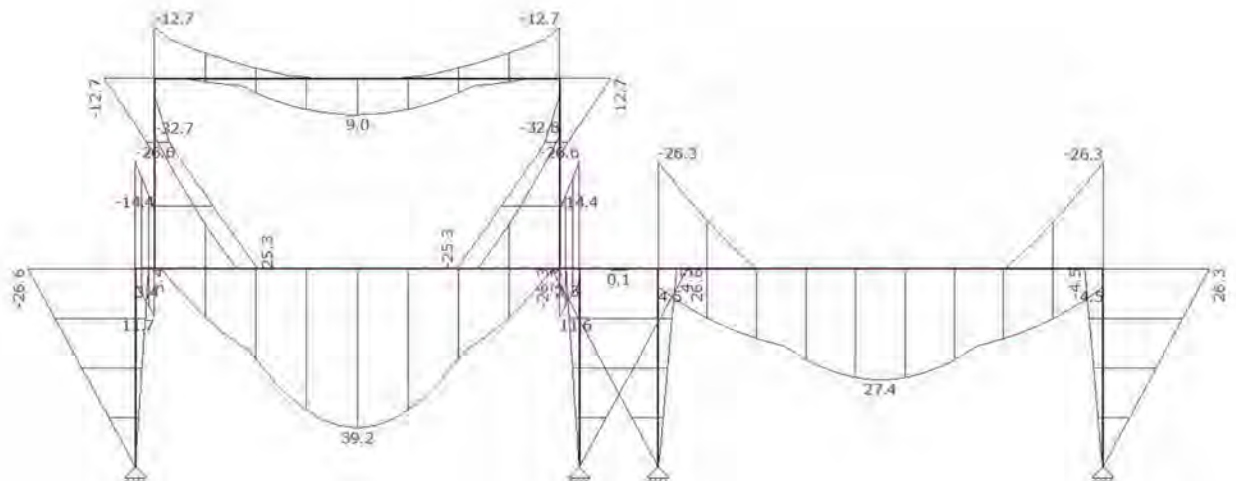

AFB. FU.C. DWARSKRACHT (VZ) OMHULLENDE

Fundamenteel Belastingscombinaties

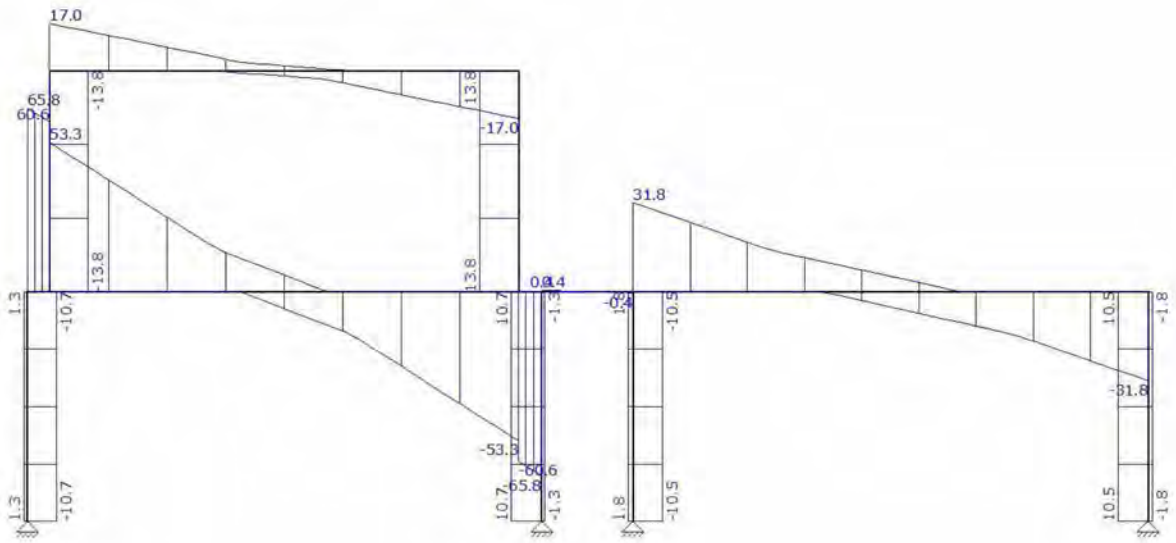

AFB. FU.C. NORMAALKRACHT (NX) OMHULLENDE

Fundamenteel Belastingscombinaties

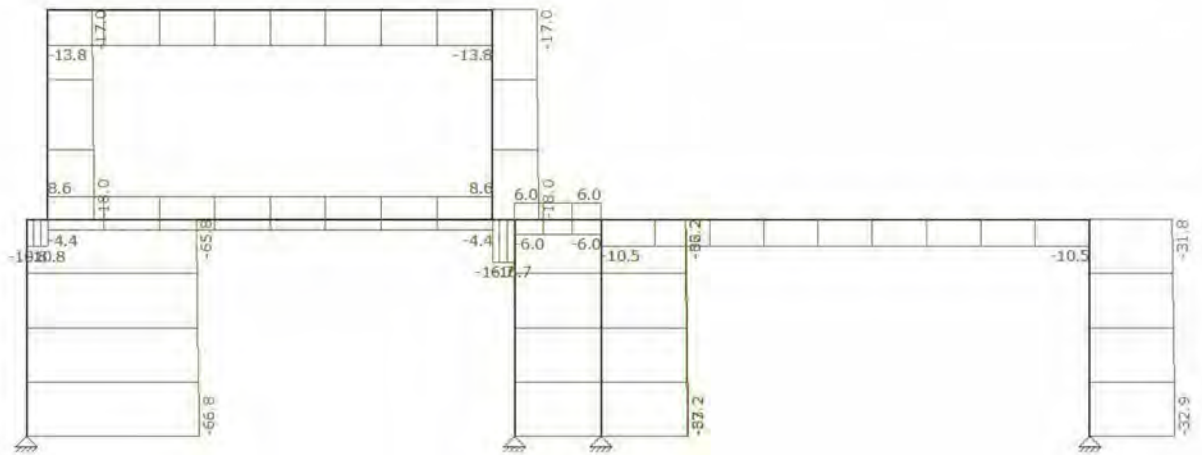

AFB. FU.C. OPLEGREACTIES OMHULLENDE

Fundamenteel Belastingscombinaties

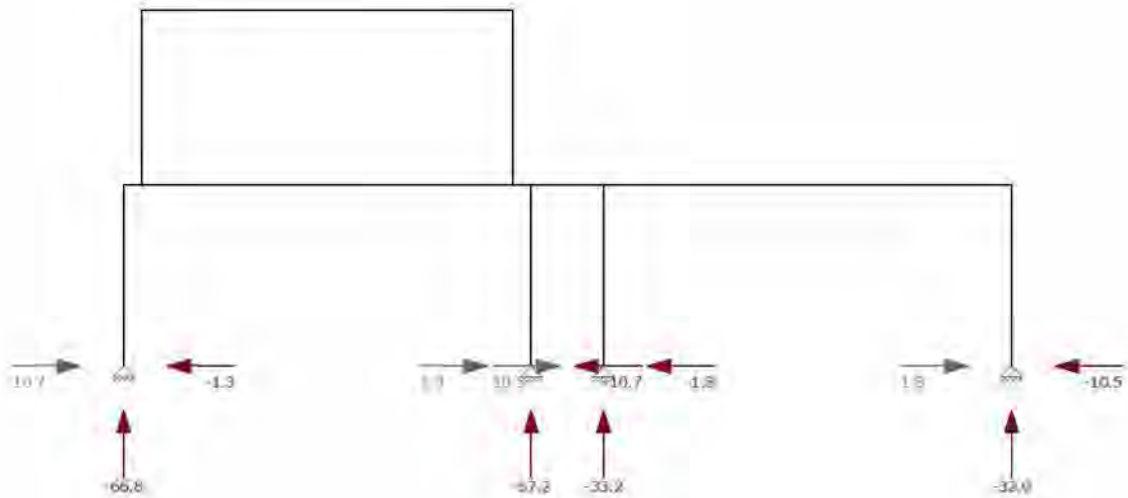

FU.C. EXTREME OPLEGREACTIES

5.1.2.e	B.C.	Xmax	Z	My B.C.	X	Zmax	My B.C.	X	Z		
Mymax											
O1	K1	Fu.C.4	10.66	-51.52	0.00						
O1	K1	Fu.C.3	-1.34	-35.80	0.00	Fu.C.2	7.71	-66.85	0.00		
O2	K2	Fu.C.4	1.33	-36.18	0.00						
O2	K2	Fu.C.3	-10.66	-51.90	0.00	Fu.C.2	-7.72	-67.22	0.00		
O3	K3	Fu.C.4	10.53	-27.13	0.00						
O3	K3	Fu.C.3	-1.78	-16.14	0.00	Fu.C.2	6.88	-33.23	0.00		
O4	K4	Fu.C.4	1.79	-15.76	0.00						
O4	K4	Fu.C.3	-10.52	-26.76	0.00	Fu.C.2	-6.87	-32.86	0.00		
Globale extreme waarden											
O1	K1	Fu.C.4	10.66	-51.52	0.00						
O2	K2	Fu.C.3	-10.66	-51.90	0.00						
O2	K2				Fu.C.2	-7.72	-67.22	0.00			
-	-	-	kN	kN	kNm	-	kN	kN	kNm	kN	kN

AFB. KA.C. VERPLAATSINGEN OMHULLENDE

Karakteristiek Belastingscombinaties

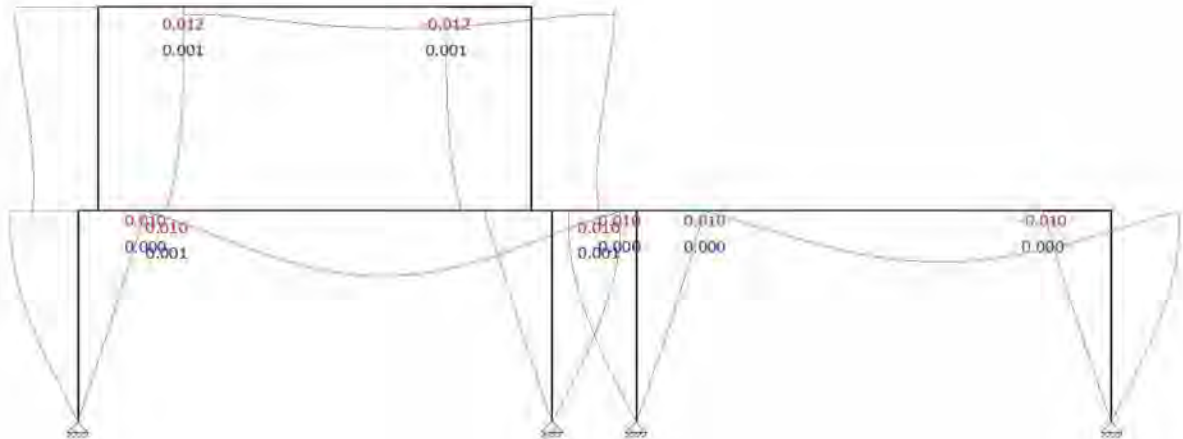

KA.C. EXTREME DOORBUIGINGEN

Staal	B.C.	Knoop Begin		Staal		Knoop Eind	
				Z'afst	Z'		
S1	Ka.C.4	0,010	0,000	0,140	0.0000	0,010	0,001
S1	Ka.C.5	-0,010	0,000	0,118	0.0000	-0,010	0,000
S2	Ka.C.3	0,000	0,001	2,550	0.0084	0,000	0,001
S3	Ka.C.4	0,010	0,000	0,132	0.0000	0,010	0,000
S3	Ka.C.5	-0,010	0,001	0,110	0.0000	-0,010	0,000
S4	Ka.C.2	0,000	0,000	0,500	0.0000	0,000	0,000
S5	Ka.C.3	0,000	0,000	2,800	0.0074	0,000	0,000
S6	Ka.C.2	0,000	0,001	2,550	0.0024	0,000	0,001
S6	Ka.C.3	0,000	0,001	3,874	-0.0004	0,000	0,001
S7	Ka.C.4	0,000	0,000	1,443	0.0001	0,010	0,000
S7	Ka.C.5	0,000	0,000	1,443	-0.0024	-0,010	0,000
S8	Ka.C.3	0,000	0,001	0,886	0.0015	0,000	0,001
S9	Ka.C.3	0,000	0,001	0,886	-0.0015	0,000	0,001
S10	Ka.C.4	0,000	0,000	1,443	0.0024	0,010	0,000
S10	Ka.C.5	0,000	0,000	1,443	-0.0001	-0,010	0,000
S11	Ka.C.4	0,000	0,000	1,443	0.0002	0,010	0,000
S11	Ka.C.5	0,000	0,000	1,443	-0.0024	-0,010	0,000
S12	Ka.C.4	0,000	0,000	1,443	0.0024	0,010	0,000
S12	Ka.C.5	0,000	0,000	1,443	-0.0002	-0,010	0,000
-	-	m	m	m	m	m	m

AFB. STAALCONTROLE

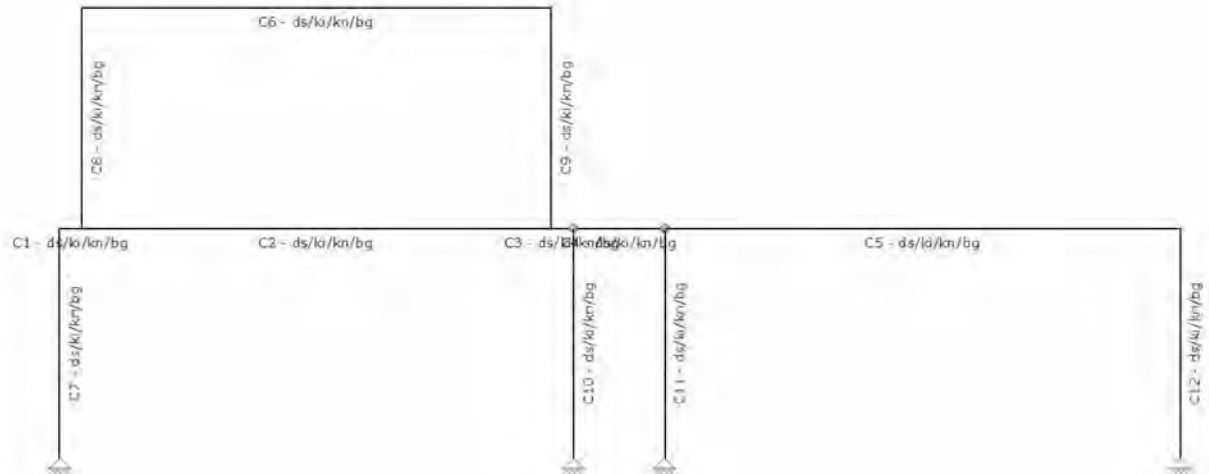

SAMENSTELLING CONSTRUCTIEDELEN

Constructiedeel	Staal/staven
C1	S1
C2	S2
C3	S3
C4	S4
C5	S5
C6	S6
C7	S7
C8	S8
C9	S9
C10	S10
C11	S11
C12	S12

KNIKLENGTEGEGEVENS

Staal	Profiel	Lokale Y-as				Lokale Z-as			
		Lsys Lbuc/Lsys	methode	Lbuc	Lbuc/Lsys	methode	Lbuc		
C1 - V1 (0.000-0.250)	P1	0.250	Ongeschoord	1.262	5.05	Cons. gesch.	0.250	1.00	
C2 - V1 (0.000-5.100)	P1	5.100	Ongeschoord	9.621	1.89	Cons. gesch.	5.100	1.00	
C3 - V1 (0.000-0.250)	P1	0.250	Ongeschoord	1.262	5.05	Cons. gesch.	0.250	1.00	
C4 - V1 (0.000-1.000)	P5	1.000	Ongeschoord	5.050	5.05	Cons. gesch.	1.000	1.00	
C5 - V1 (0.000-5.600)	P1	5.600	Cons. gesch.	5.600	1.00	Cons. gesch.	5.600	1.00	
C6 - V1 (0.000-5.100)	P2	5.100	Ongeschoord	7.439	1.46	Cons. gesch.	5.100	1.00	
C7 - V1 (0.000-2.500)	P3	2.500	Ongeschoord	12.625	5.05	Cons. gesch.	2.500	1.00	
C8 - V1 (0.000-2.400)	P4	2.400	Ongeschoord	3.671	1.53	Cons. gesch.	2.400	1.00	
C9 - V1 (0.000-2.400)	P4	2.400	Ongeschoord	3.501	1.46	Cons. gesch.	2.400	1.00	
C10 - V1 (0.000-2.500)	P3	2.500	Ongeschoord	5.684	2.27	Cons. gesch.	2.500	1.00	
C11 - V1 (0.000-2.500)	P3	2.500	Cons. gesch.	2.500	1.00	Cons. gesch.	2.500	1.00	
C12 - V1 (0.000-2.500)	P3	2.500	Cons. gesch.	2.500	1.00	Cons. gesch.	2.500	1.00	
-	-	m	-	m	-	-	m	-	-

KIPSTEUNENGEGEVENS

Staf	Profiel	Begin:	Eind:	Kipsteunen boven	Kipsteunen onder
Aangrijphoogte					
C1 - V1 (0.000-0.250)	P1	Gesteund	Gesteund		Centrum
C2 - V1 (0.000-5.100)	P1	Gesteund	Gesteund		Centrum
C3 - V1 (0.000-0.250)	P1	Gesteund	Gesteund		Centrum
C4 - V1 (0.000-1.000)	P5	Gesteund	Gesteund		Centrum
C5 - V1 (0.000-5.600)	P1	Gesteund	Gesteund		Centrum
C6 - V1 (0.000-5.100)	P2	Gesteund	Gesteund		Centrum
C7 - V1 (0.000-2.500)	P3	Gesteund	Gesteund		Centrum
C8 - V1 (0.000-2.400)	P4	Gesteund	Gesteund		Centrum
C9 - V1 (0.000-2.400)	P4	Gesteund	Gesteund		Centrum
C10 - V1 (0.000-2.500)	P3	Gesteund	Gesteund		Centrum
C11 - V1 (0.000-2.500)	P3	Gesteund	Gesteund		Centrum
C12 - V1 (0.000-2.500)	P3	Gesteund	Gesteund		Centrum
-	-	-	-	m	m

DOORBUIGINGGEGEVENS

Staf	Constructietype	Toetsing	Zeeg Y'	Zeeg Z'	Zeegvorm	w;max
w;2+w;3						
C1 - V1 (0.000-0.250)	Dak	Algemeen	0	0	3-punt	L/250
C2 - V1 (0.000-5.100)	Vloer	Algemeen	0	0	3-punt	L/250
C3 - V1 (0.000-0.250)	Dak	Algemeen	0	0	3-punt	L/250
C5 - V1 (0.000-5.600)	Dak	Algemeen	0	0	3-punt	L/250
C6 - V1 (0.000-5.100)	Dak	Algemeen	0	0	3-punt	L/250
C7 - V1 (0.000-2.500)	Kolom	1 bouwlaag			3-punt	H/300
C8 - V1 (0.000-2.400)	Kolom	1 bouwlaag			3-punt	H/300
C9 - V1 (0.000-2.400)	Kolom	1 bouwlaag			3-punt	H/300
C10 - V1 (0.000-2.500)	Kolom	1 bouwlaag			3-punt	H/300
C11 - V1 (0.000-2.500)	Kolom	1 bouwlaag			Parabolisch	H/300
C12 - V1 (0.000-2.500)	Kolom	1 bouwlaag			Parabolisch	H/300
-	-	-	mm	mm	-	-

AFB. STAAL UC DIAGRAM

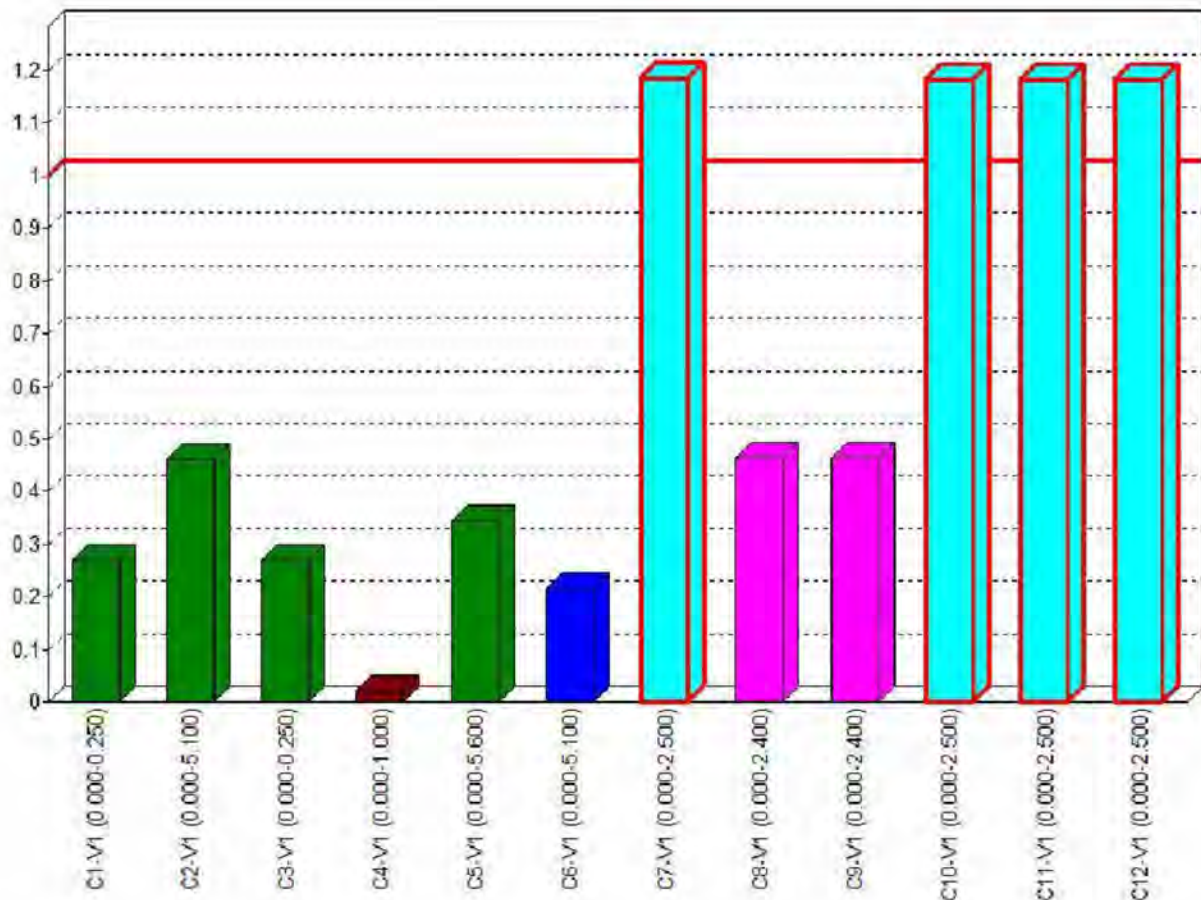

UNITY CHECK NEN-EN1993-1-1:2016/NB:2016

Veld	Toetsing	Combinatie	Artikel	UC max
C1-V1 (0.000-0.250)	Doorsnede	Fu.C.2	NEN-EN1993-1-1(6.17)	0,27
C1-V1 (0.000-0.250)	Stabiliteit	Fu.C.4	NEN-EN1993-1-1(6.46)	0,01
C1-V1 (0.000-0.250)	Stabiliteit	Fu.C.4	NEN-EN1993-1-1(6.46)	0,01
C1-V1 (0.000-0.250)	Stabiliteit	Fu.C.4	NEN-EN1993-1-1(6.61&6.62)	0,22
C1-V1 (0.000-0.250)	Kiptoetsing	Fu.C.5	NEN-EN1993-1-1(6.54)	0,00
C1-V1 (0.000-0.250)	Doorbuigingstoetsing	Ka.C.5	NEN-EN NEN-EN1990/NB A1.4.2	0,01
C2-V1 (0.000-5.100)	Doorsnede	Fu.C.2	NEN-EN1993-1-1(6.12)	0,39
C2-V1 (0.000-5.100)	Stabiliteit	Fu.C.3	NEN-EN1993-1-1(6.46)	0,01
C2-V1 (0.000-5.100)	Stabiliteit	Fu.C.3	NEN-EN1993-1-1(6.46)	0,01
C2-V1 (0.000-5.100)	Stabiliteit	Fu.C.3	NEN-EN1993-1-1(6.61&6.62)	0,37
C2-V1 (0.000-5.100)	Kiptoetsing	Fu.C.2	NEN-EN1993-1-1(6.54)	0,46
C2-V1 (0.000-5.100)	Doorbuigingstoetsing	Qu.C.1	NEN-EN NEN-EN1990/NB A1.4.2	0,24
C3-V1 (0.000-0.250)	Doorsnede	Fu.C.2	NEN-EN1993-1-1(6.17)	0,27
C3-V1 (0.000-0.250)	Stabiliteit	Fu.C.3	NEN-EN1993-1-1(6.46)	0,01
C3-V1 (0.000-0.250)	Stabiliteit	Fu.C.3	NEN-EN1993-1-1(6.46)	0,01
C3-V1 (0.000-0.250)	Stabiliteit	Fu.C.3	NEN-EN1993-1-1(6.61&6.62)	0,23
C3-V1 (0.000-0.250)	Kiptoetsing	Fu.C.5	NEN-EN1993-1-1(6.54)	0,00
C3-V1 (0.000-0.250)	Doorbuigingstoetsing	Ka.C.4	NEN-EN NEN-EN1990/NB A1.4.2	0,01
C4-V1 (0.000-1.000)	Doorsnede	Fu.C.4	NEN-EN1993-1-1(6.5)	0,00

Veld	Toetsing	Combinatie	Artikel	UC max
C4-V1 (0.000-1.000)	Stabiliteit	Fu.C.3	NEN-EN1993-1-1(6.46)	0,02
C4-V1 (0.000-1.000)	Stabiliteit	Fu.C.3	NEN-EN1993-1-1(6.46)	0,00
C4-V1 (0.000-1.000)	Stabiliteit	Fu.C.3	NEN-EN1993-1-1(6.61&6.62)	0,02
C4-V1 (0.000-1.000)	Kiptoetsing	Fu.C.5	NEN-EN1993-1-1(6.54)	0,00
C5-V1 (0.000-5.600)	Doorsnede	Fu.C.2	NEN-EN1993-1-1(6.12)	0,27
C5-V1 (0.000-5.600)	Stabiliteit	Fu.C.2	NEN-EN1993-1-1(6.46)	0,01
C5-V1 (0.000-5.600)	Stabiliteit	Fu.C.2	NEN-EN1993-1-1(6.46)	0,01
C5-V1 (0.000-5.600)	Stabiliteit	Fu.C.2	NEN-EN1993-1-1(6.61&6.62)	0,34
C5-V1 (0.000-5.600)	Kiptoetsing	Fu.C.2	NEN-EN1993-1-1(6.54)	0,33
C5-V1 (0.000-5.600)	Doorbuigingstoetsing	Ka.C.3	NEN-EN NEN-EN1990/NB A1.4.2	0,33
C6-V1 (0.000-5.100)	Doorsnede	Fu.C.1	NEN-EN1993-1-1(6.12)	0,17
C6-V1 (0.000-5.100)	Stabiliteit	Fu.C.1	NEN-EN1993-1-1(6.46)	0,02
C6-V1 (0.000-5.100)	Stabiliteit	Fu.C.1	NEN-EN1993-1-1(6.46)	0,03
C6-V1 (0.000-5.100)	Stabiliteit	Fu.C.1	NEN-EN1993-1-1(6.61&6.62)	0,22
C6-V1 (0.000-5.100)	Kiptoetsing	Fu.C.1	NEN-EN1993-1-1(6.54)	0,19
C6-V1 (0.000-5.100)	Doorbuigingstoetsing	Ka.C.2	NEN-EN NEN-EN1990/NB A1.4.2	0,12
C7-V1 (0.000-2.500)	Doorsnede	Fu.C.4	NEN-EN1993-1-1(6.12)	0,46
C7-V1 (0.000-2.500)	Stabiliteit	Fu.C.2	NEN-EN1993-1-1(6.46)	0,40
C7-V1 (0.000-2.500)	Stabiliteit	Fu.C.2	NEN-EN1993-1-1(6.46)	0,09
C7-V1 (0.000-2.500)	Stabiliteit	Fu.C.2	NEN-EN1993-1-1(6.61&6.62)	0,67
C7-V1 (0.000-2.500)	Kiptoetsing	Fu.C.5	NEN-EN1993-1-1(6.54)	0,00
C7-V1 (0.000-2.500)	Doorbuigingstoetsing	Ka.C.4	NEN-EN NEN-EN1990/NB A1.4.2	1,18
C8-V1 (0.000-2.400)	Doorsnede	Fu.C.2	NEN-EN1993-1-1(6.12)	0,44
C8-V1 (0.000-2.400)	Stabiliteit	Fu.C.2	NEN-EN1993-1-1(6.46)	0,01
C8-V1 (0.000-2.400)	Stabiliteit	Fu.C.2	NEN-EN1993-1-1(6.46)	0,01
C8-V1 (0.000-2.400)	Stabiliteit	Fu.C.2	NEN-EN1993-1-1(6.61&6.62)	0,47
C8-V1 (0.000-2.400)	Kiptoetsing	Fu.C.5	NEN-EN1993-1-1(6.54)	0,00
C8-V1 (0.000-2.400)	Doorbuigingstoetsing	Ka.C.4	NEN-EN NEN-EN1990/NB A1.4.2	0,30
C9-V1 (0.000-2.400)	Doorsnede	Fu.C.2	NEN-EN1993-1-1(6.12)	0,44
C9-V1 (0.000-2.400)	Stabiliteit	Fu.C.2	NEN-EN1993-1-1(6.46)	0,01
C9-V1 (0.000-2.400)	Stabiliteit	Fu.C.2	NEN-EN1993-1-1(6.46)	0,01
C9-V1 (0.000-2.400)	Stabiliteit	Fu.C.2	NEN-EN1993-1-1(6.61&6.62)	0,47
C9-V1 (0.000-2.400)	Kiptoetsing	Fu.C.5	NEN-EN1993-1-1(6.54)	0,00
C9-V1 (0.000-2.400)	Doorbuigingstoetsing	Ka.C.5	NEN-EN NEN-EN1990/NB A1.4.2	0,30
C10-V1 (0.000-2.500)	Doorsnede	Fu.C.3	NEN-EN1993-1-1(6.12)	0,46
C10-V1 (0.000-2.500)	Stabiliteit	Fu.C.3	NEN-EN1993-1-1(6.46)	0,09
C10-V1 (0.000-2.500)	Stabiliteit	Fu.C.3	NEN-EN1993-1-1(6.46)	0,07
C10-V1 (0.000-2.500)	Stabiliteit	Fu.C.3	NEN-EN1993-1-1(6.61&6.62)	0,55
C10-V1 (0.000-2.500)	Kiptoetsing	Fu.C.5	NEN-EN1993-1-1(6.54)	0,00
C10-V1 (0.000-2.500)	Doorbuigingstoetsing	Ka.C.4	NEN-EN NEN-EN1990/NB A1.4.2	1,18
C11-V1 (0.000-2.500)	Doorsnede	Fu.C.4	NEN-EN1993-1-1(6.12)	0,46
C11-V1 (0.000-2.500)	Stabiliteit	Fu.C.4	NEN-EN1993-1-1(6.46)	0,03
C11-V1 (0.000-2.500)	Stabiliteit	Fu.C.4	NEN-EN1993-1-1(6.46)	0,04
C11-V1 (0.000-2.500)	Stabiliteit	Fu.C.4	NEN-EN1993-1-1(6.61&6.62)	0,51
C11-V1 (0.000-2.500)	Kiptoetsing	Fu.C.5	NEN-EN1993-1-1(6.54)	0,00
C11-V1 (0.000-2.500)	Doorbuigingstoetsing	Ka.C.4	NEN-EN NEN-EN1990/NB A1.4.2	1,18
C12-V1 (0.000-2.500)	Doorsnede	Fu.C.3	NEN-EN1993-1-1(6.12)	0,46
C12-V1 (0.000-2.500)	Stabiliteit	Fu.C.3	NEN-EN1993-1-1(6.46)	0,03
C12-V1 (0.000-2.500)	Stabiliteit	Fu.C.3	NEN-EN1993-1-1(6.46)	0,04
C12-V1 (0.000-2.500)	Stabiliteit	Fu.C.3	NEN-EN1993-1-1(6.61&6.62)	0,51
C12-V1 (0.000-2.500)	Kiptoetsing	Fu.C.5	NEN-EN1993-1-1(6.54)	0,00
C12-V1 (0.000-2.500)	Doorbuigingstoetsing	Ka.C.5	NEN-EN NEN-EN1990/NB A1.4.2	1,18

GEWICHT STAALCONSTRUCTIE

StAAF	Profiel	Lsys	Massa
C4-V1 (0.000-1.000)	C100	1,000	61,654
Subtotaal:	C100	1,000	61,654
C10-V1 (0.000-2.500)	HE140B	2,500	84,301
C11-V1 (0.000-2.500)	HE140B	2,500	84,301
C12-V1 (0.000-2.500)	HE140B	2,500	84,301
C7-V1 (0.000-2.500)	HE140B	2,500	84,301
C8-V1 (0.000-2.400)	HE140B	2,400	80,929
C9-V1 (0.000-2.400)	HE140B	2,400	80,929
Subtotaal:	HE140B	14,800	499,064
C6-V1 (0.000-5.100)	HE180A	5,100	181,164
Subtotaal:	HE180A	5,100	181,164
C1-V1 (0.000-0.250)	HE200A	0,250	10,564
C2-V1 (0.000-5.100)	HE200A	5,100	215,513
C3-V1 (0.000-0.250)	HE200A	0,250	10,564
C5-V1 (0.000-5.600)	HE200A	5,600	236,642
Subtotaal:	HE200A	11,200	473,284
Totaal:		32,100	1.215,166
		m	kg

8.16 Bijlage uitraai MatrixFrame berekening Pos 16

AFB. GEOMETRIE 1 STAVEN EN KNOPEN

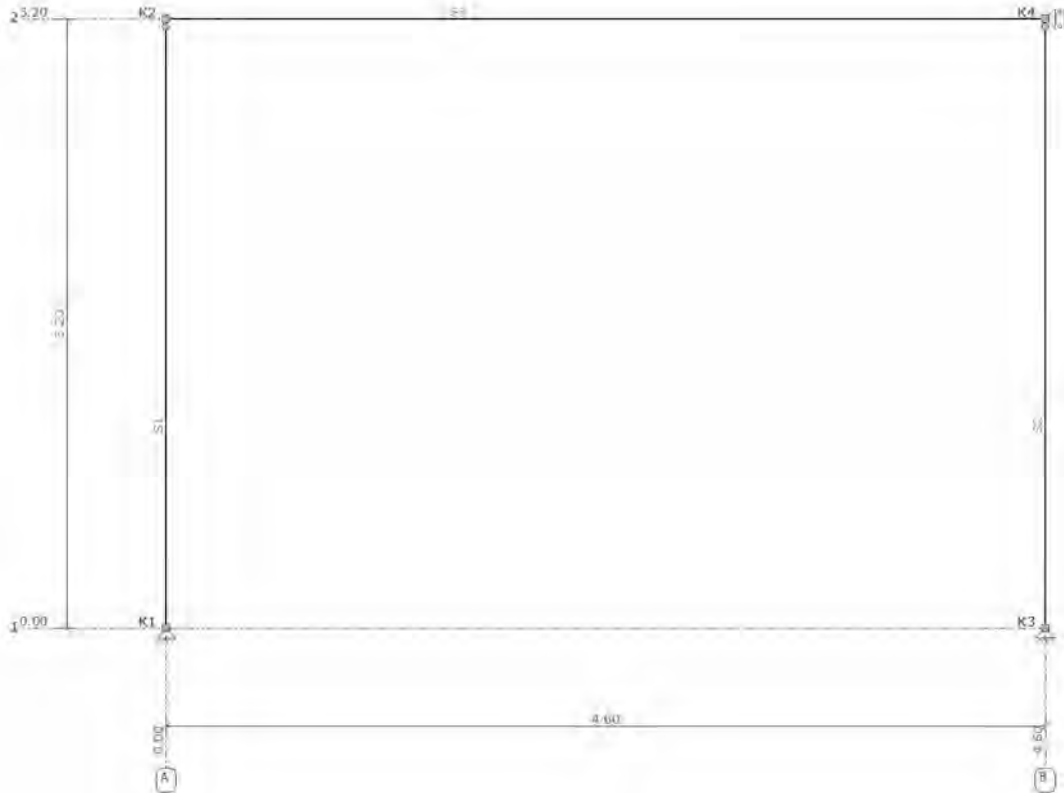

STAVEN

Staf	Knoop B	Knoop E	X-B	Z-B	X-E	Z-E	Lengte	Profiel
S1	K1	K2	0.000	0.000	0.000	-3.200	3.200	P1
S2	K3	K4	4.600	0.000	4.600	-3.200	3.200	P1
S3	K2	K4	0.000	-3.200	4.600	-3.200	4.600	P2
-	-	-	m	m	m	m	m	-

SCHARNIEREN

Staf	Positie	Oplegg.	Scharnier	Yr
S1	0.000	A1	vast	vast
	L(3.200)	A2	vast	vrij
S2	0.000	A1	vast	vast
	L(3.200)	A2	vast	vrij
S3	0.000	A1	vast	vast
	L(4.600)	A1	vast	vast
-	m	-	kN/m	kN/m
				kNm/rad

AFB. GEOMETRIE 2 STAVEN EN KNOPEN

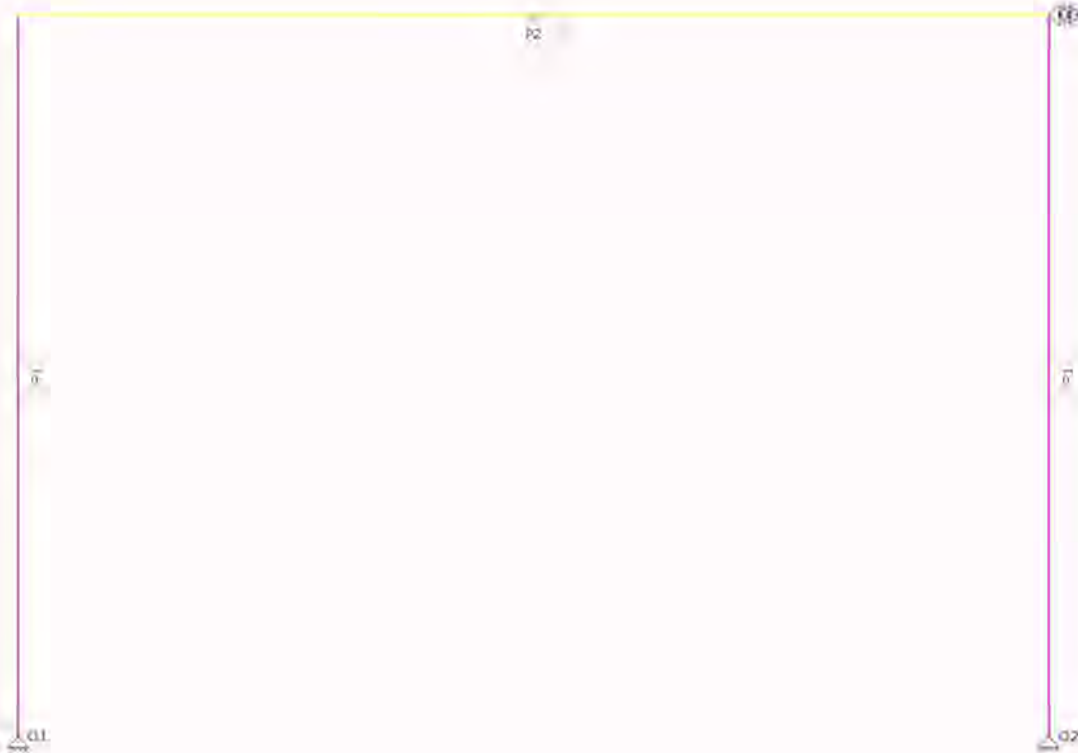

PROFIELEN

Profiel	Profielnaam	Oppervlakte	Iy	Materiaal	5.1.2.e
P1	HE100A	2.1236e-03	3.4923e-06	S235	0.0
P2	HE180A	4.5251e-03	2.5103e-05	S235	0.0
-	-	m ²	m ⁴	-	°

MATERIALEN

Materiaal	Dichtheid	E-Modulus	Uitzettingcoeff
S235	78.50	2.1000e+08	12.0000e-06
-	kN/m ³	kN/m ²	C°m

OPLEGGINGEN

Oplegging	Object	Positie	Z	Yr	HoekYr	
O1	K1	0.000	vast	vast	vrij	0
O2	K3	0.000	vast	vast	vrij	0
O3	K4	0.000	vast	0.00:0.00	vrij	0
-	-	m	kN/m	kN/m	kNm/rad	°

BELASTINGSGEVALLEN TYPEN

Oplegg.	Staven	5.1.2.e	Gunstig/Ong. Element	5.1.2.e	Psi0	Psi1	Cprob
Psi2	UGT/GGT						
B.G.1	Permanent	Permanent	-	N.v.t.	N.v.t.		
B.G.2	Verdeelde veranderlijke	Verdeelde	-	Cat. A) Vloeren	1	1	0.40 0.50
0.30	1.00/1.00 belasting	veranderlijke belasting					

Oplegg.	Staven	5.1.2.e	Gunstig/Ong. Element	5.1.2.e	Psi0	Psi1	Cprob
Psi2	UGT/GGT						
B.G.3	Kniklengte (Assymetrisch)	Kniklengte			N.v.t.	N.v.t.	
B.G.4	Kniklengte (Symmetrisch)	Kniklengte			N.v.t.	N.v.t.	

AFB. LASTEN B.G.1 PERMANENT

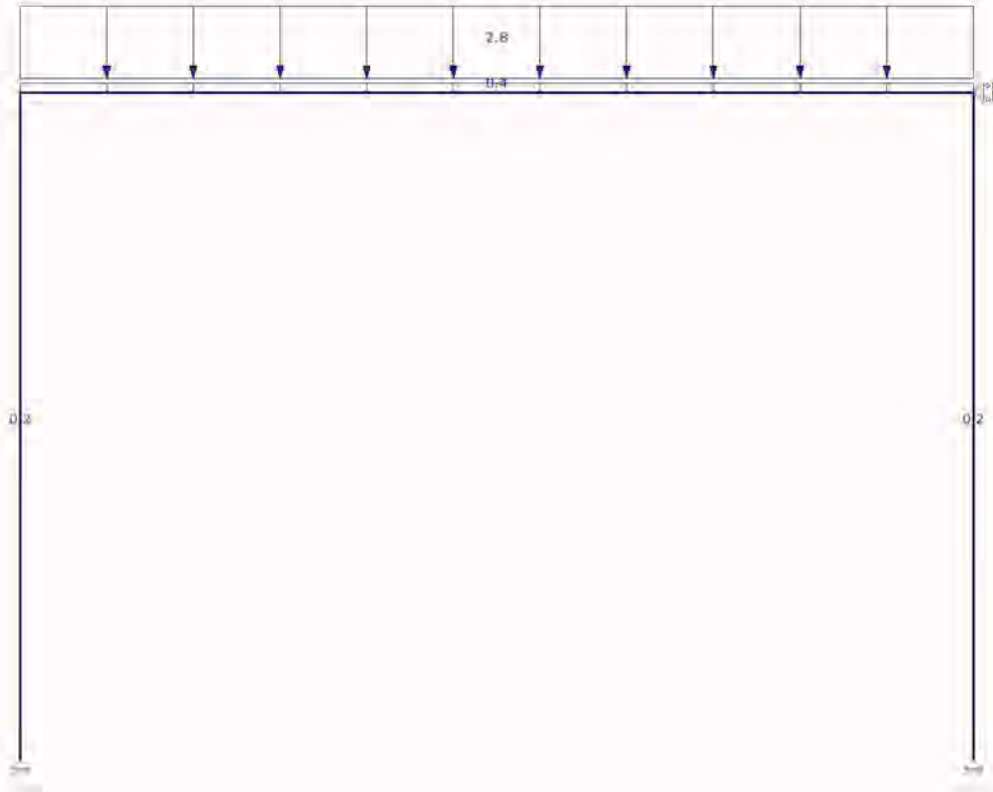

AFB. LASTEN B.G.2 VERDEELDE VERANDERLIJKE BELASTING



AFB. LASTEN B.G.3 KNIKLENGTE (ASSYMETRISCH)

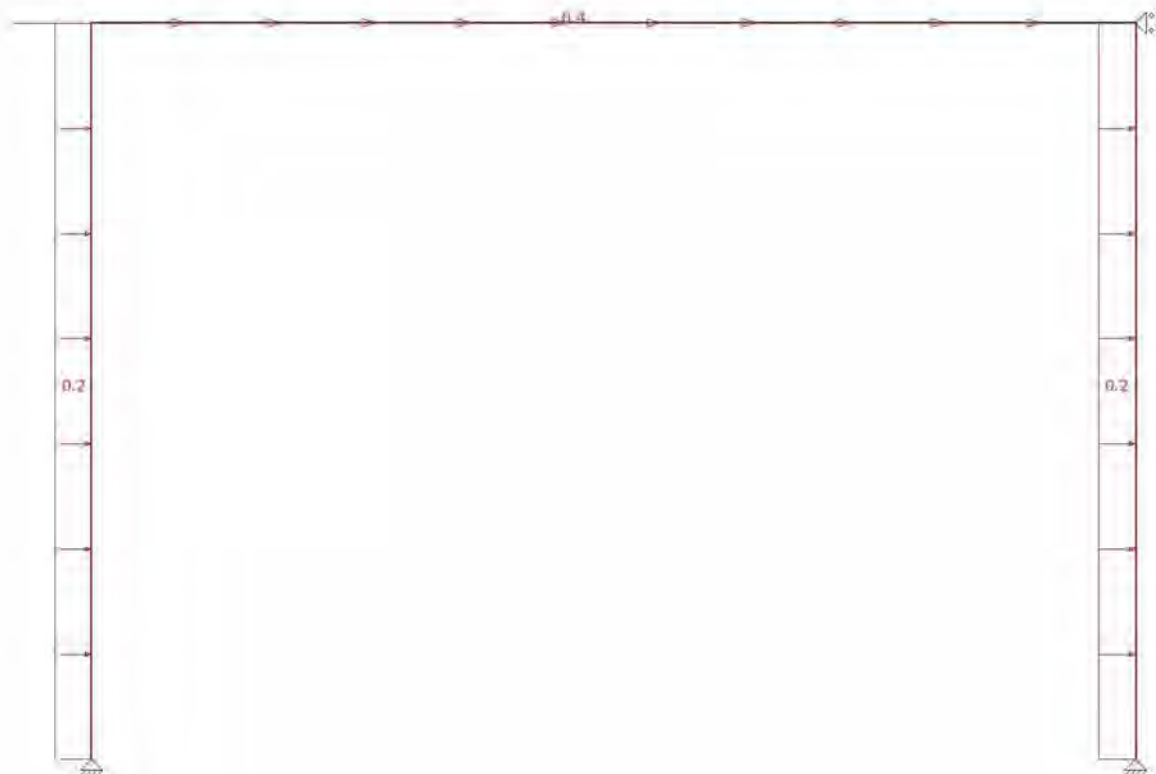

AFB. LASTEN B.G.4 KNIKLENGTE (SYMMETRISCH)

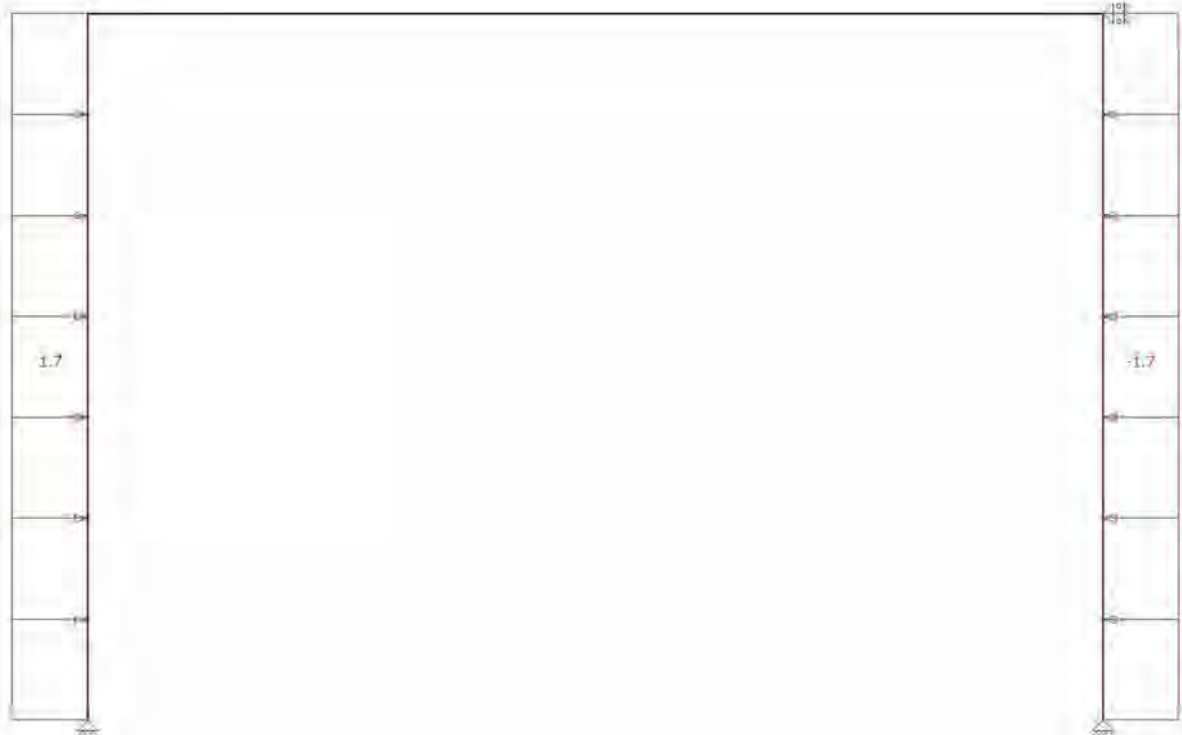

FUNDAMENTEEL BELASTINGSCOMBINATIES (TABEL)

B.G.	Omschrijving	Fu.C.1	Fu.C.2
B.G.1	Permanent	1.20	1.35
B.G.2	Verdeelde veranderlijke belasting	1.50	0.60
B.G.3	Kniklengte (Assymetrisch)	-	-
B.G.4	Kniklengte (Symmetrisch)	-	-

KARAKTERISTIEK BELASTINGSCOMBINATIES (TABEL)

B.G.	Omschrijving	Ka.C.(w1)		Ka.C.1	Ka.C.2
B.G.1	Permanent	1.00	1.00	1.00	1.00
B.G.2	Verdeelde veranderlijke belasting	-	0.40	1.00	1.00
B.G.3	Kniklengte (Assymetrisch)	-	-	-	-
B.G.4	Kniklengte (Symmetrisch)	-	-	-	-

FREQUENT BELASTINGSCOMBINATIES (TABEL)

B.G.	Omschrijving	Fr.C.(w1)	Fr.C.1
B.G.1	Permanent	1.00	1.00
B.G.2	Verdeelde veranderlijke belasting	-	0.50
B.G.3	Kniklengte (Assymetrisch)	-	-
B.G.4	Kniklengte (Symmetrisch)	-	-

QUASI-PERMANENT BELASTINGSCOMBINATIES (TABEL)

B.G.	Omschrijving	Qu.C.1
B.G.1	Permanent	1.00
B.G.2	Verdeelde veranderlijke belasting	0.30
B.G.3	Kniklengte (Assymetrisch)	-

B.G.4 Kniklengte (Symmetrisch) -

UITGANGSPUNTEN VAN DE ANALYSE

Lineaire Elastische Analyse uitgevoerd

AFB. FU.C. MOMENT (MY) OMHULLENDE

Fundamenteel Belastingscombinaties

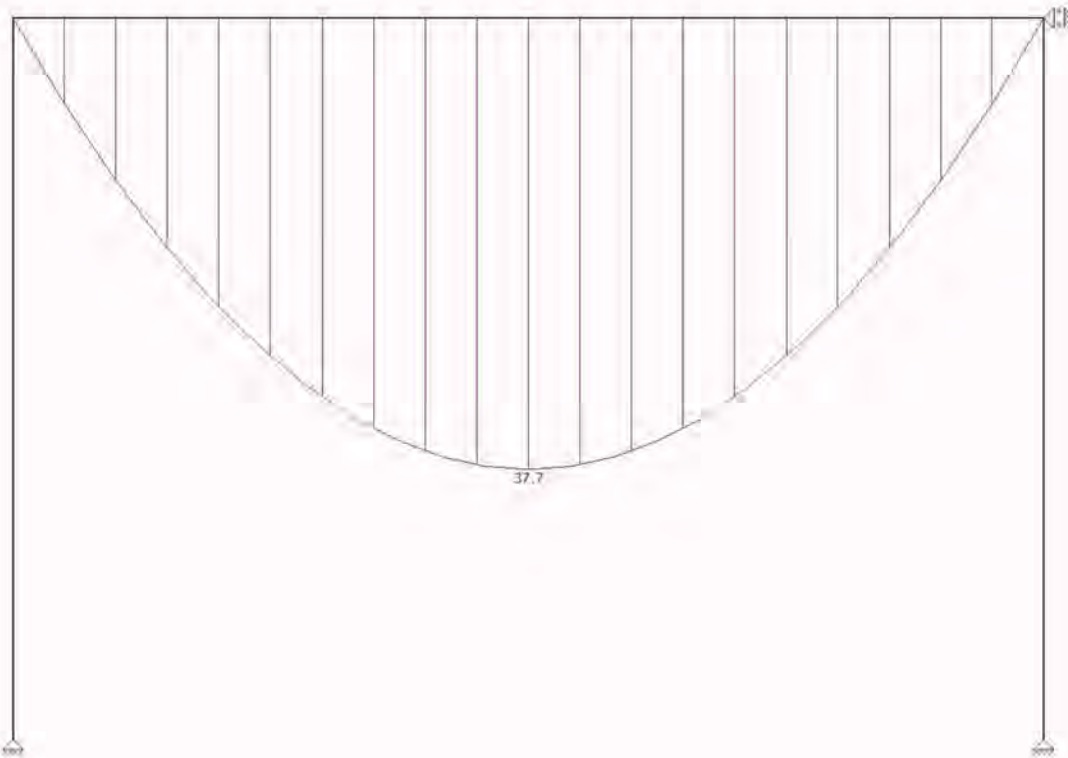

AFB. FU.C. DWARSKRACHT (VZ) OMHULLENDE

Fundamenteel Belastingscombinaties

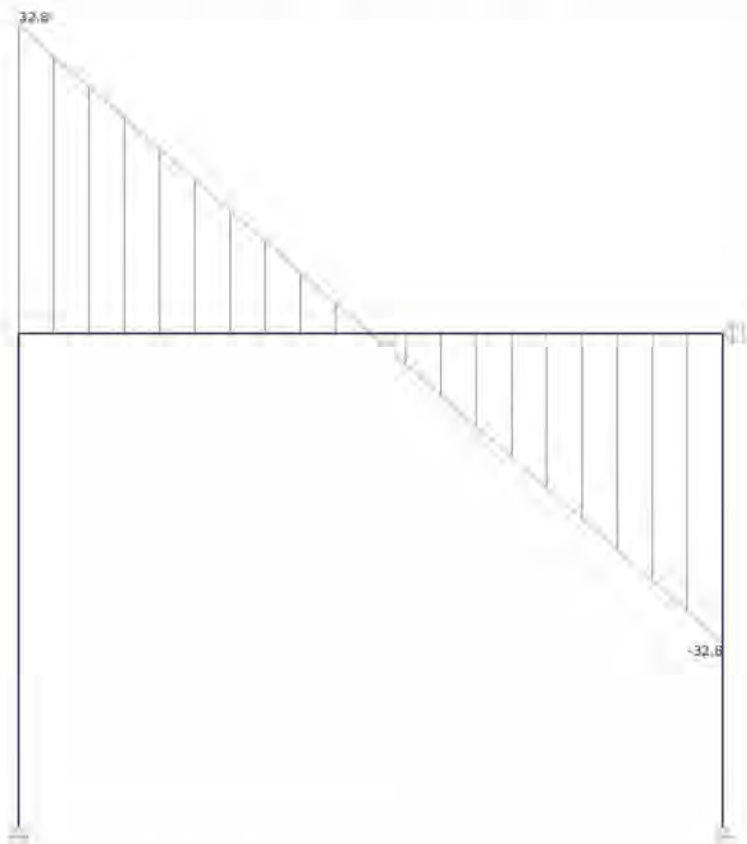

AFB. FU.C. NORMAALKRACHT (NX) OMHULLENDE

Fundamenteel Belastingscombinaties

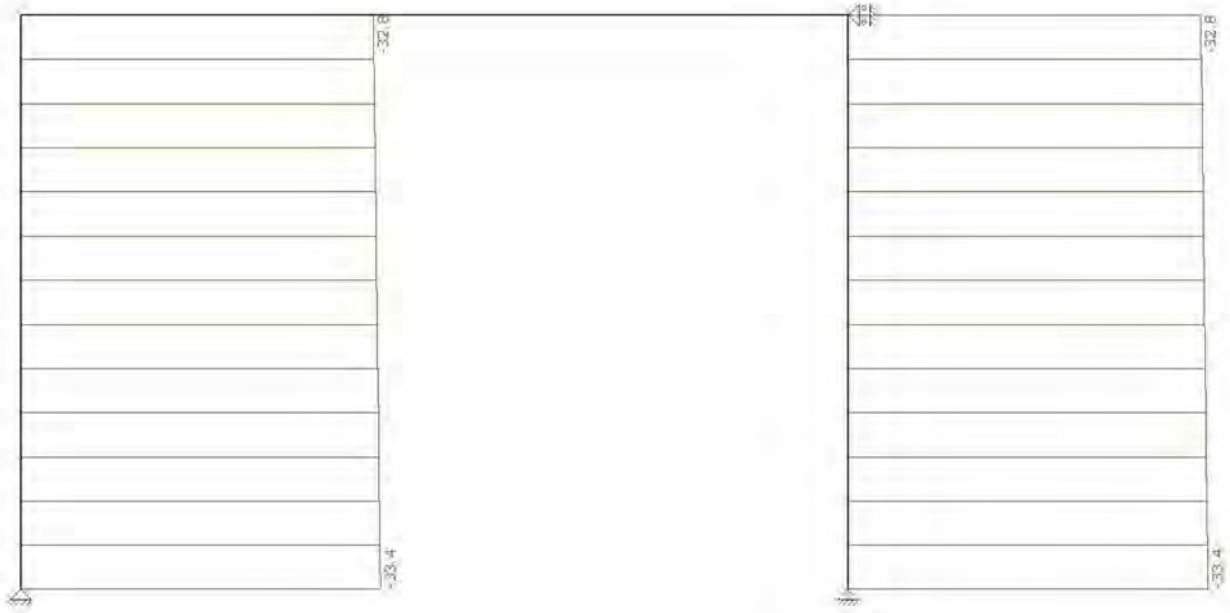

AFB. FU.C. OPLEGREACTIES OMHULLENDE

Fundamenteel Belastingscombinaties

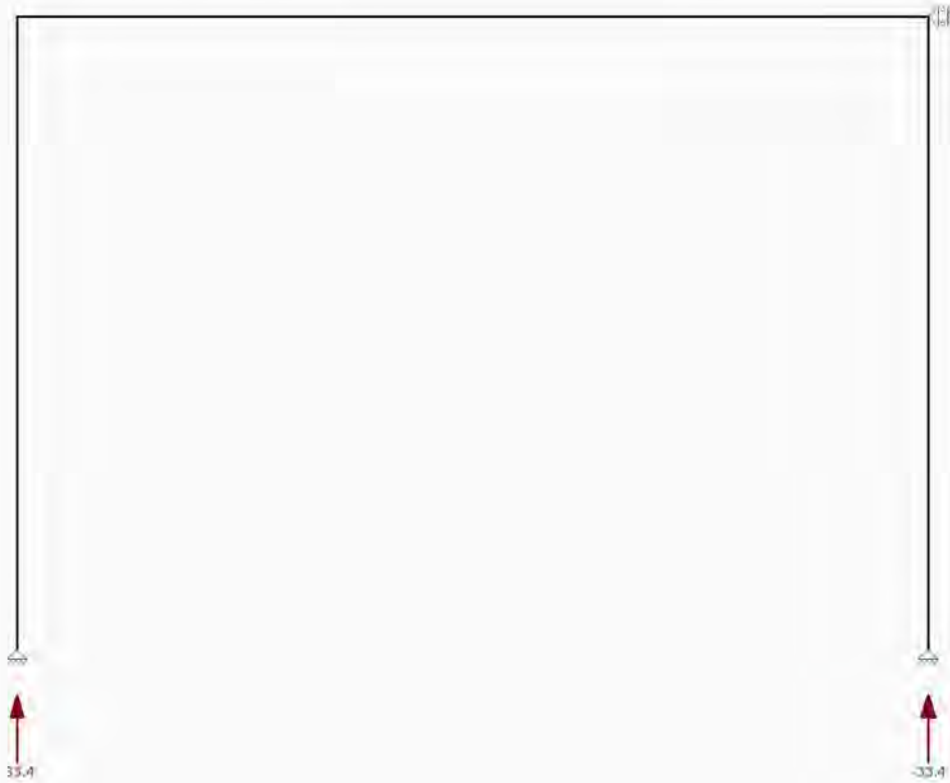

FU.C. EXTREME OPLEGREACTIES

5.1.2.e	B.C.	Xmax	My B.C.	Zmax	My B.C.
Mymax					
O1	K1		Fu.C.1	0.00 -33.41	0.00
O2	K3		Fu.C.1	0.00 -33.41	0.00
Globale extreme waarden					
O2	K3		Fu.C.1	0.00 -33.41	0.00
-	-	-	kN	kN	kNm
kN	kNm				kN

AFB, KA.C. VERPLAATSINGEN OMHULLENDE

Karakteristiek Belastingscombinaties



KA.C. EXTREME DOORBUIGINGEN

Staaf	B.C.	Knoop Begin		Staaf	Z'	Knoop Eind	
				Z'afst			
S3	Ka.C.2	0.000	0.000	2.300	0.0112	0.000	0.000
-	-	m	m	m	m	m	m

AFB. STAALCONTROLE



SAMENSTELLING CONSTRUCTIEDELEN

Constructiedeel	Staal / staven
C1	S1
C2	S2
C3	S3

KNIKLENGTEGEGEVENS

Staal	Profiel	Lokale Y-as				Lokale Z-as		
		Lsys Lbuc/Lsys	methode	Lbuc	Lbuc/Lsys	methode	Lbuc	
C1 - V1 (0.000-3.200)	P1	3.200	Geschoord	3.080	0.96	Cons. gesch.	3.200	1.00
C2 - V1 (0.000-3.200)	P1	3.200	Geschoord	3.080	0.96	Cons. gesch.	3.200	1.00
-	-	m	-	m	-	-	m	-

KIPSTEUNENEGEGEVENS

Staal	Profiel	Begin:	Eind:	Kipsteunen boven	Kipsteunen onder
Aangrijphoogte					
C1 - V1 (0.000-3.200)	P1	Gesteund	Gesteund		Centrum
C2 - V1 (0.000-3.200)	P1	Gesteund	Gesteund		Centrum
C3 - V1 (0.000-4.600)	P2	Gesteund	Gesteund		Centrum
-	-	-	-	m	m

DOORBUIGINGGEGEVENS

Staal	Constructietype	Toetsing	Zeeg Y'	Zeeg Z'	Zeegvorm	w;max
w;2+w;3						

C1 - V1 (0.000-3.200) Kolom N/B	1 bouwlaag		3-punt	H/300
C2 - V1 (0.000-3.200) Kolom N/B	1 bouwlaag		3-punt	H/300
C3 - V1 (0.000-4.600) Vloer L/333	Algemeen	0	0 3-punt	L/250
-	-	-	mm	mm -

AFB. STAAL UC DIAGRAM

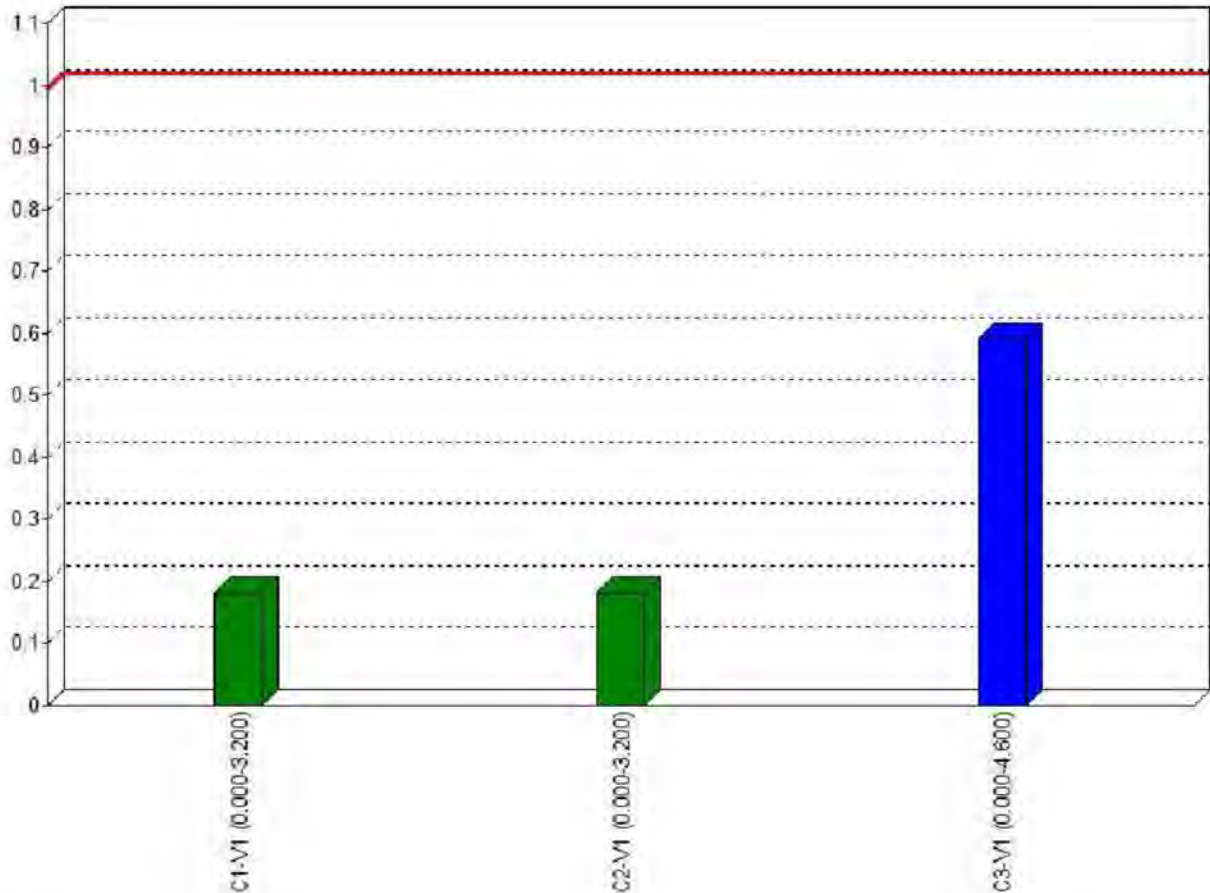

UNITY CHECK NEN-EN1993-1-1:2016/NB:2016

Veld	Toetsing	Combinatie	Artikel	UC max
C1-V1 (0.000-3.200)	Doorsnede	Fu.C.1	NEN-EN1993-1-1(6.9)	0.07
C1-V1 (0.000-3.200)	Stabiliteit	Fu.C.1	NEN-EN1993-1-1(6.46)	0.09
C1-V1 (0.000-3.200)	Stabiliteit	Fu.C.1	NEN-EN1993-1-1(6.46)	0.18
C1-V1 (0.000-3.200)	Stabiliteit	Fu.C.1	NEN-EN1993-1-1(6.61&6.62)	0.18
C1-V1 (0.000-3.200)	Kiptoetsing	Fu.C.2	NEN-EN1993-1-1(6.54)	0.00
C1-V1 (0.000-3.200)	Doorbuigingstoetsing	Ka.C.1	NEN-EN NEN-EN1990/NB A1.4.2	0.00
C2-V1 (0.000-3.200)	Doorsnede	Fu.C.1	NEN-EN1993-1-1(6.9)	0.07
C2-V1 (0.000-3.200)	Stabiliteit	Fu.C.1	NEN-EN1993-1-1(6.46)	0.09
C2-V1 (0.000-3.200)	Stabiliteit	Fu.C.1	NEN-EN1993-1-1(6.46)	0.18
C2-V1 (0.000-3.200)	Stabiliteit	Fu.C.1	NEN-EN1993-1-1(6.61&6.62)	0.18
C2-V1 (0.000-3.200)	Kiptoetsing	Fu.C.2	NEN-EN1993-1-1(6.54)	0.00
C2-V1 (0.000-3.200)	Doorbuigingstoetsing	Ka.C.1	NEN-EN NEN-EN1990/NB A1.4.2	0.00

Veld	Toetsing	Combinatie	Artikel	UC max
C3-V1 (0.000-4.600)	Doorsnede	Fu.C.1	NEN-EN1993-1-1(6.12)	0.49
C3-V1 (0.000-4.600)	Kiptoetsing	Fu.C.1	NEN-EN1993-1-1(6.54)	0.59
C3-V1 (0.000-4.600)	Doorbuigingstoetsing	Qu.C.1	NEN-EN1990/NB A1.4.2	0.31

GEWICHT STAALCONSTRUCTIE

Staafl	Profiel	Lsys	Massa
C1-V1 (0.000-3.200)	HE100A	3.200	53.345
C2-V1 (0.000-3.200)	HE100A	3.200	53.345
Subtotaal:	HE100A	6.400	106.690
C3-V1 (0.000-4.600)	HE180A	4.600	163.403
Subtotaal:	HE180A	4.600	163.403
Totaal:		11.000	270.093
		m	kg

8.17 Bijlage uitraai MatrixFrame berekening Pos 17

AFB. GEOMETRIE LIGGER

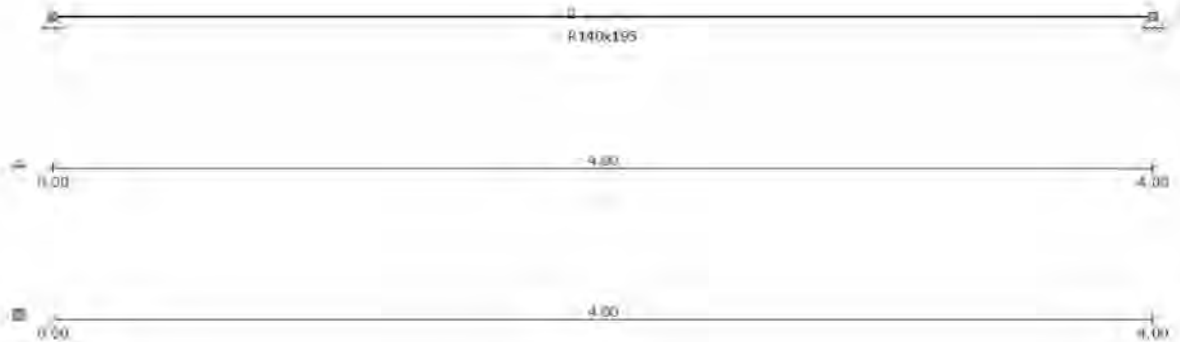

BALKGEOMETRIE

Positie	Profielnaam	5.1.2.e	Traagheidsmoment	Materiaal	E-Modulus	Uitzettingcoeff
0,000 - L(4,000)	R140x195	0	8.6507e-05	C24	1.1000e+07	50.0000e-07
0.11	m -	⊕	m ⁴ -		kN/m ²	C⊕m
	kN/m					

PROFIELVORMEN

Profiel	Verl. h.	hB	hE	tf	tw	tf2	B	bL	bR	Raatl.
P1	Nee	0,195	0,195	0,0000	0,0000	0,0000	0,140	0,000	0,000	Nee 0,000
-	-	m	m	m	m	m	m	m	m	m - m

MATERIALEN

Materiaalnaam	Poison	Dichtheid	E-Modulus	Uitzettingcoeff
C24	0.40	4.20	1.1000e+07	50.0000e-07
-	-	kN/m ³	kN/m ²	C⊕m

OPLEGGINGEN

Oplegging	Positie	Z	Yr
O1	0,000	Vast	Vrij
O2	L(4,000)	Vast	Vrij
-	m	kN/m	kNm/rad

BELASTINGSGEVALLEN TYPEN

Oplegg.	Staven	5.1.2.e	Gunstig/Ong. Element	5.1.2.e	Psi0	Psi1	Cprob
Psi2	UGT/GGT						
B.G.1	Permanent	Permanent	-	N.v.t.	N.v.t.		
B.G.2	Verdeelde veranderlijke	Verdeelde	-	Cat. A) Vloeren	1	1	0.40 0.50
0.30	1,00/1,00 belasting	veranderlijke belasting					
B.G.3	Geconcentreerde	Geconcentreerde	-	Cat. A) Vloeren	N.v.t.	N.v.t.	0.40 0.50
0.30	veranderlijke belasting	veranderlijke belasting					
B.G.2.1	Verdeelde veranderlijke	Verdeelde	-	Cat. A) Vloeren	1	1	0.40 0.50
0.30	1,00/1,00 belasting (1)	veranderlijke belasting					

AFB. LASTEN B.G.1 PERMANENT

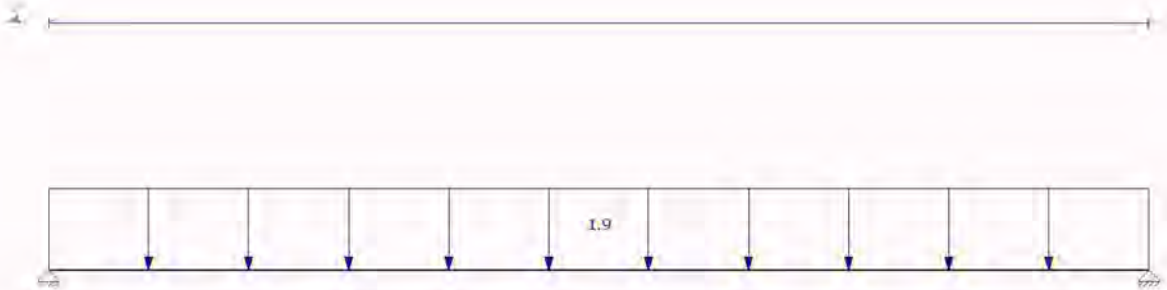

AFB. LASTEN B.G.2 VERDEELDE VERANDERLIJKE BELASTING

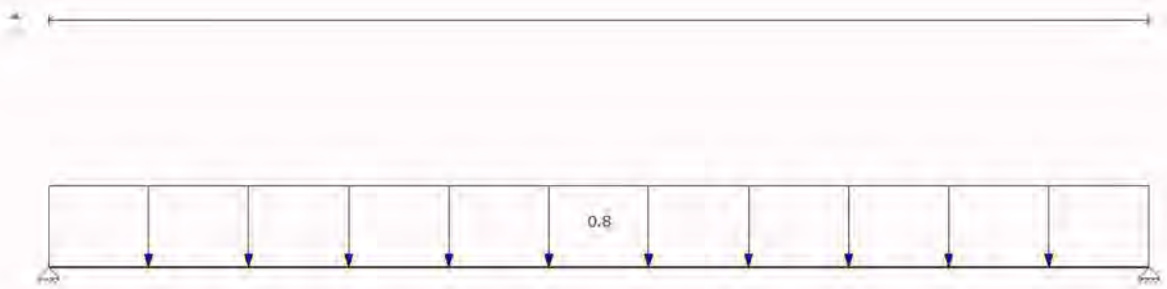

AFB. LASTEN B.G.3 GECONCENTREERDE VERANDERLIJKE BELASTING

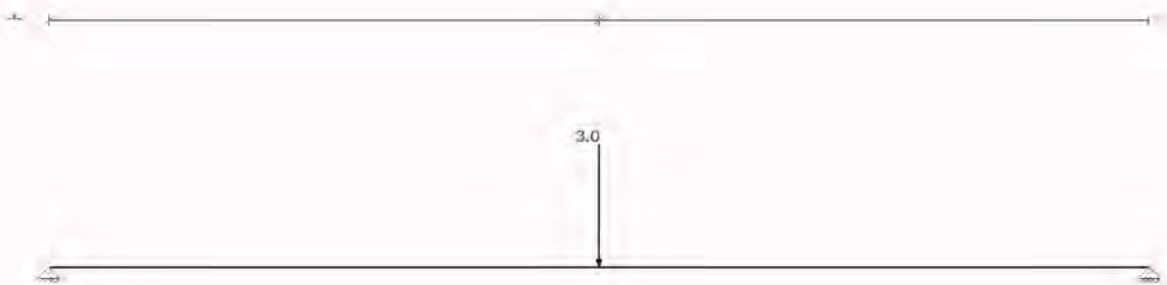

AFB. LASTEN B.G. 2.1 VERDEELDE VERANDERLIJKE BELASTING (1)

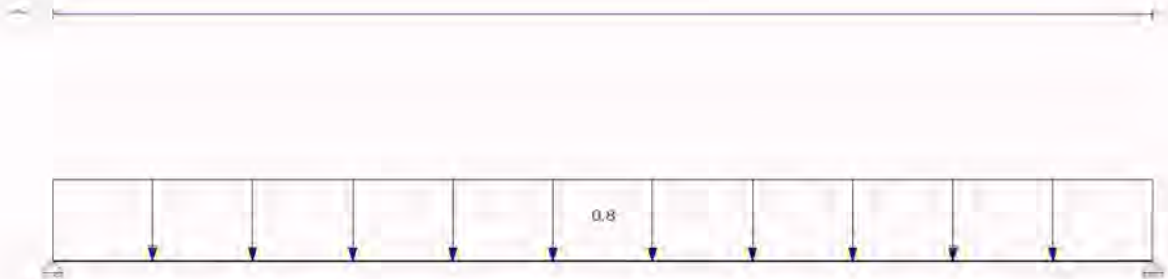

FUNDAMENTEEL BELASTINGSCOMBINATIES (TABEL)

B.G.	Omschrijving	Fu.C.1	Fu.C.2	Fu.C.3	Fu.C.4
B.G.1	Permanent	1.20	1.20	1.35	1.35
B.G.2	Verdeelde veranderlijke belasting	-	-	-	-
B.G.3	Geconcentreerde veranderlijke belasting	-	1.50	-	0.60
B.G.2.1	Verdeelde veranderlijke belasting (1)	1.50	-	0.60	-

KARAKTERISTIEK BELASTINGSCOMBINATIES (TABEL)

B.G.	Omschrijving	Ka.C.(w1)	Ka.C.1	Ka.C.2
B.G.1	Permanent	1.00	1.00	1.00
B.G.2	Verdeelde veranderlijke belasting	-	-	-
B.G.3	Geconcentreerde veranderlijke belasting	-	-	-
B.G.2.1	Verdeelde veranderlijke belasting (1)	-	0.40	1.00

FREQUENT BELASTINGSCOMBINATIES (TABEL)

B.G.	Omschrijving	Fr.C.(w1)	Fr.C.1
B.G.1	Permanent	1.00	1.00
B.G.2	Verdeelde veranderlijke belasting	-	-
B.G.3	Geconcentreerde veranderlijke belasting	-	-
B.G.2.1	Verdeelde veranderlijke belasting (1)	-	0.50

QUASI-PERMANENT BELASTINGSCOMBINATIES (TABEL)

B.G.	Omschrijving	Qu.C.1
B.G.1	Permanent	1.00
B.G.2	Verdeelde veranderlijke belasting	-
B.G.3	Geconcentreerde veranderlijke belasting	-
B.G.2.1	Verdeelde veranderlijke belasting (1)	0.30

UITGANGSPUNTEN VAN DE ANALYSE

Lineaire Elastische Analyse uitgevoerd

AFB. FU.C. MOMENT (MY) OMHULLENDE

Fundamenteel Belastingscombinaties

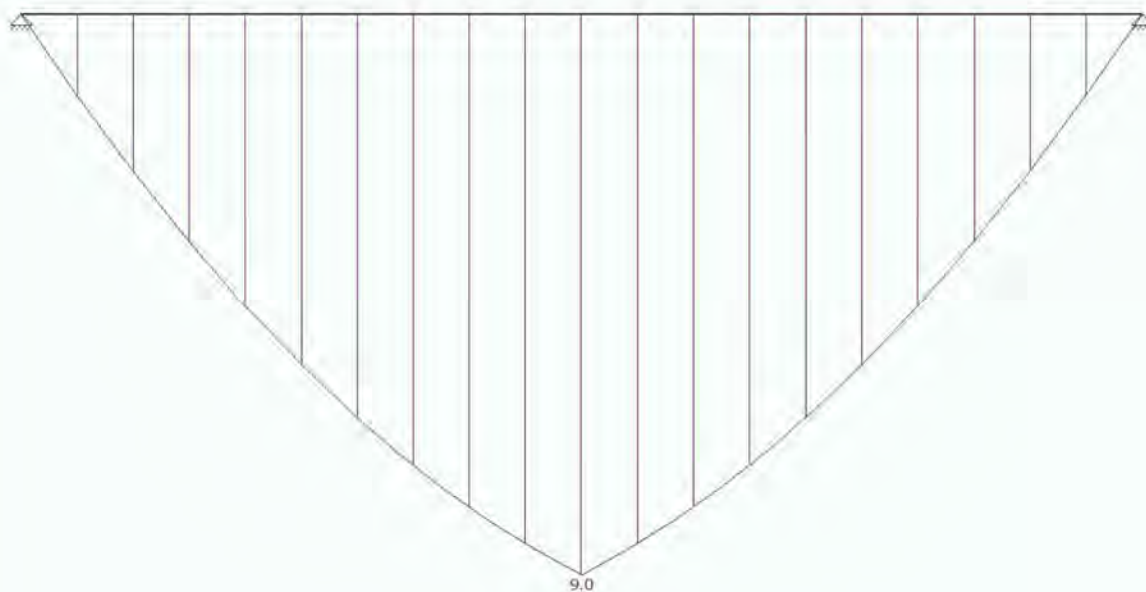

AFB. FU.C. DWARSKRACHT (VZ) OMHULLENDE

Fundamenteel Belastingscombinaties

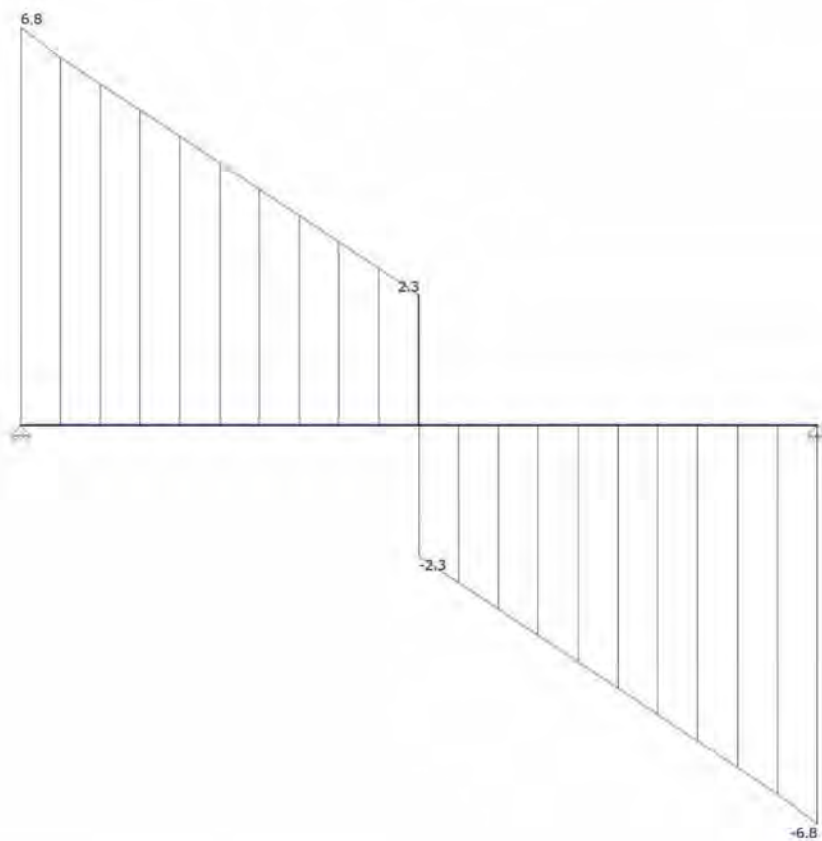

AFB. FU.C. OPLEGREACTIES OMHULLENDE

Fundamenteel Belastingscombinaties



AFB. KA.C. VERPLAATSINGEN OMHULLENDE

Karakteristiek Belastingscombinaties



AFB. HOUTCONTROLE

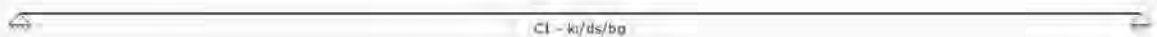

SAMENSTELLING CONSTRUCTIEDELEN

Constructiedeel	Staal/staven
C1	S1

STABILITEITSGEGEVENS

Staal	Profiel	Y-As (assenstelsel)			Z-As(assenstelsel)		
		Lsys Kkip/Lsys	Methode	Lkip	Kkip/Lsys	Methode	Lkip
C1 - V1 (0.000-4.000)	P1	4,000	Conservatief	4.000	1.00	Conservatief	4.000
1.00							
-	-	geschoord				geschoord	
		m		m		m	

KIPSTEUNENGEGEVENS

Staal last	Profiel	Begin	Eind	Kipsteunen boven	Kipsteunen onder	Aangrijppunt
------------	---------	-------	------	------------------	------------------	--------------

C1 - V1 (0.000-4.000)	P1	inklemming	inklemming				Neutraal
-	-	-	-	m	m	-	-
		Volledig vast	Volledig vast				

DOORBUIGINGGEGEVENS

Staf	Constr.type	Toetsingstype	Zeeg Y'	Zeeg Z'	Zeegvorm	w;max
w;2+w;3						
C1 - V1 (0.000-4.000)	Vloer	Algemeen	0	0	Parabolisch	L/250
L/333						
-	-	-	mm	mm	-	-

UNITY CHECK

Label	Toetsing	Combinatie	Artikel	UC max
C1	Doorsnede	Fu.C.2	NEN-EN1995-1-1#6.1.6 (6.11)	0,69
	Kip	Fu.C.2	NEN-EN1995-1-1#6.3.3 (6.33)	0,69
	Doorbuiging	Ka.C.2	NEN-EN1995#7.2 NEN-EN1990#A1.4.3(4)	0,86

8.18 Bijlage uitraai MatrixFrame berekening Pos 18

AFB. GEOMETRIE LIGGER

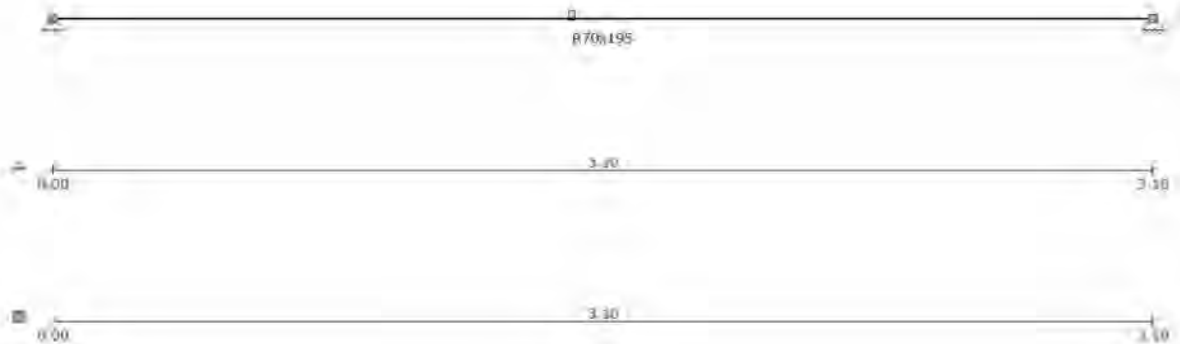

BALKGEOMETRIE

Positie	Profielnaam	5.1.2.e	Traagheidsmoment	Materiaal	E-Modulus	Uitzettingcoeff
0,000	L(3,100) R70x195	0	4.3253e-05	C24	1.1000e+07	50.0000e-07
0.06						
	m -		m ⁴ -		kN/m ²	C _⊕ m
	kN/m					

PROFIELVORMEN

Profiel	Verl. h.	hB	hE	tf	tw	tf2	B	bL	bR	Raatl.
P3	Nee	0,195	0,195	0,0000	0,0000	0,0000	0,070	0,000	0,000	Nee 0,000
-	-	m	m	m	m	m	m	m	m	m - m

MATERIALEN

Materiaalnaam	Poison	Dichtheid	E-Modulus	Uitzettingcoeff
C24	0.40	4.20	1.1000e+07	50.0000e-07
-	-	kN/m ³	kN/m ²	C _⊕ m

OPLEGGINGEN

Oplegging	Positie	Z	Yr
O1	0,000	Vast	Vrij
O2	L(3,100)	Vast	Vrij
-	m	kN/m	kNm/rad

BELASTINGSGEVALLEN TYPEN

Oplegg.	Staven	5.1.2.e	Gunstig/Ong. Element	5.1.2.e	Psi0	Psi1	Cprob
Psi2	UGT/GGT						
B.G.1	Permanent	Permanent	-	N.v.t.	N.v.t.		
B.G.2	Verdeelde veranderlijke	Verdeelde	-	Cat. A) Vloeren	1	1	0.40 0.50
0.30	1,00/1,00						
	belasting	veranderlijke					
		belasting					
B.G.3	Geconcentreerde	Geconcentreerde	-	Cat. A) Vloeren	N.v.t.	N.v.t.	0.40 0.50
0.30							
	veranderlijke belasting	veranderlijke					
		belasting					
B.G.2.1	Verdeelde veranderlijke	Verdeelde	-	Cat. A) Vloeren	1	1	0.40 0.50
0.30	1,00/1,00						
	belasting (1)	veranderlijke					
		belasting					

AFB. LASTEN B.G.1 PERMANENT

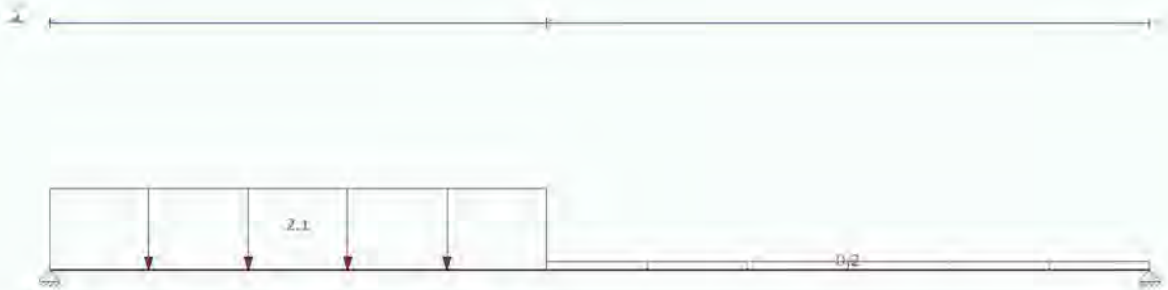

AFB. LASTEN B.G.2 VERDEELDE VERANDERLIJKE BELASTING

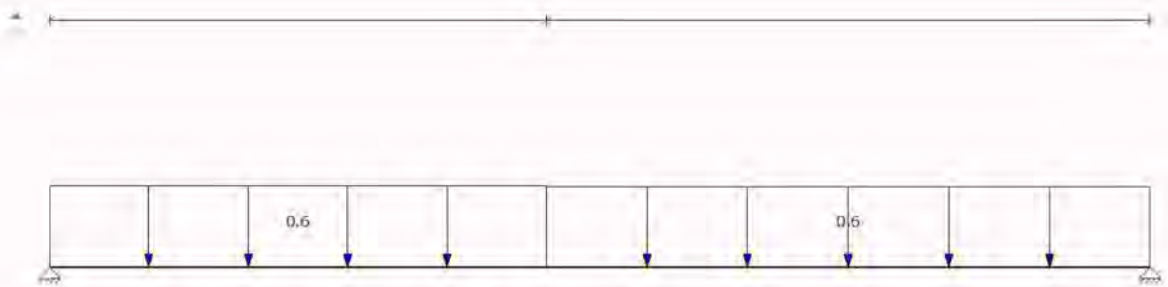

AFB. LASTEN B.G.3 GECONCENTREERDE VERANDERLIJKE BELASTING

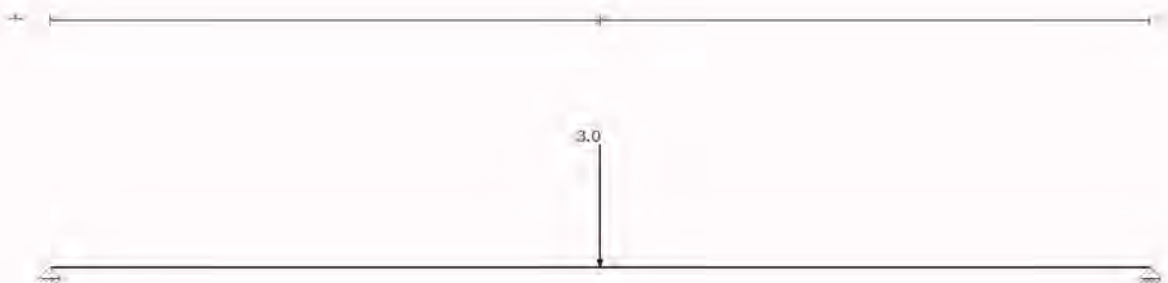

AFB. LASTEN B.G. 2.1 VERDEELDE VERANDERLIJKE BELASTING (1)

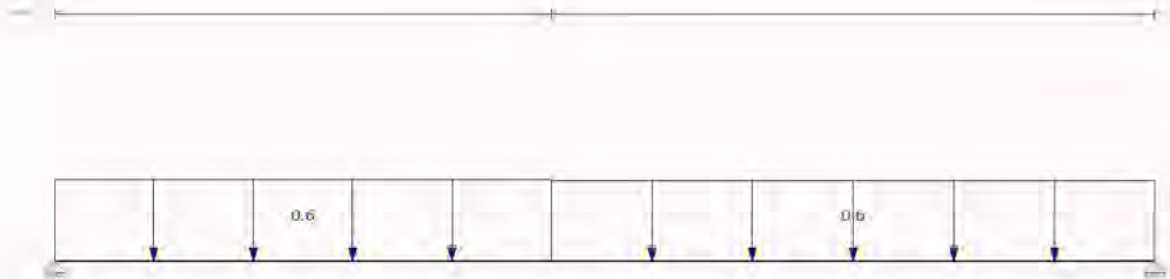

FUNDAMENTEEL BELASTINGSCOMBINATIES (TABEL)

B.G.	Omschrijving	Fu.C.1	Fu.C.2	Fu.C.3	Fu.C.4
B.G.1	Permanent	1.20	1.20	1.35	1.35
B.G.2	Verdeelde veranderlijke belasting	-	-	-	-
B.G.3	Geconcentreerde veranderlijke belasting	-	1.50	-	0.60
B.G.2.1	Verdeelde veranderlijke belasting (1)	1.50	-	0.60	-

KARAKTERISTIEK BELASTINGSCOMBINATIES (TABEL)

B.G.	Omschrijving	Ka.C.(w1)	Ka.C.1	Ka.C.2
B.G.1	Permanent	1.00	1.00	1.00
B.G.2	Verdeelde veranderlijke belasting	-	-	-
B.G.3	Geconcentreerde veranderlijke belasting	-	-	-
B.G.2.1	Verdeelde veranderlijke belasting (1)	-	0.40	1.00

FREQUENT BELASTINGSCOMBINATIES (TABEL)

B.G.	Omschrijving	Fr.C.(w1)	Fr.C.1
B.G.1	Permanent	1.00	1.00
B.G.2	Verdeelde veranderlijke belasting	-	-
B.G.3	Geconcentreerde veranderlijke belasting	-	-
B.G.2.1	Verdeelde veranderlijke belasting (1)	-	0.50

QUASI-PERMANENT BELASTINGSCOMBINATIES (TABEL)

B.G.	Omschrijving	Qu.C.1
B.G.1	Permanent	1.00
B.G.2	Verdeelde veranderlijke belasting	-
B.G.3	Geconcentreerde veranderlijke belasting	-
B.G.2.1	Verdeelde veranderlijke belasting (1)	0.30

UITGANGSPUNTEN VAN DE ANALYSE

Lineaire Elastische Analyse uitgevoerd

AFB. FU.C. MOMENT (MY) OMHULLENDE

Fundamenteel Belastingcombinaties

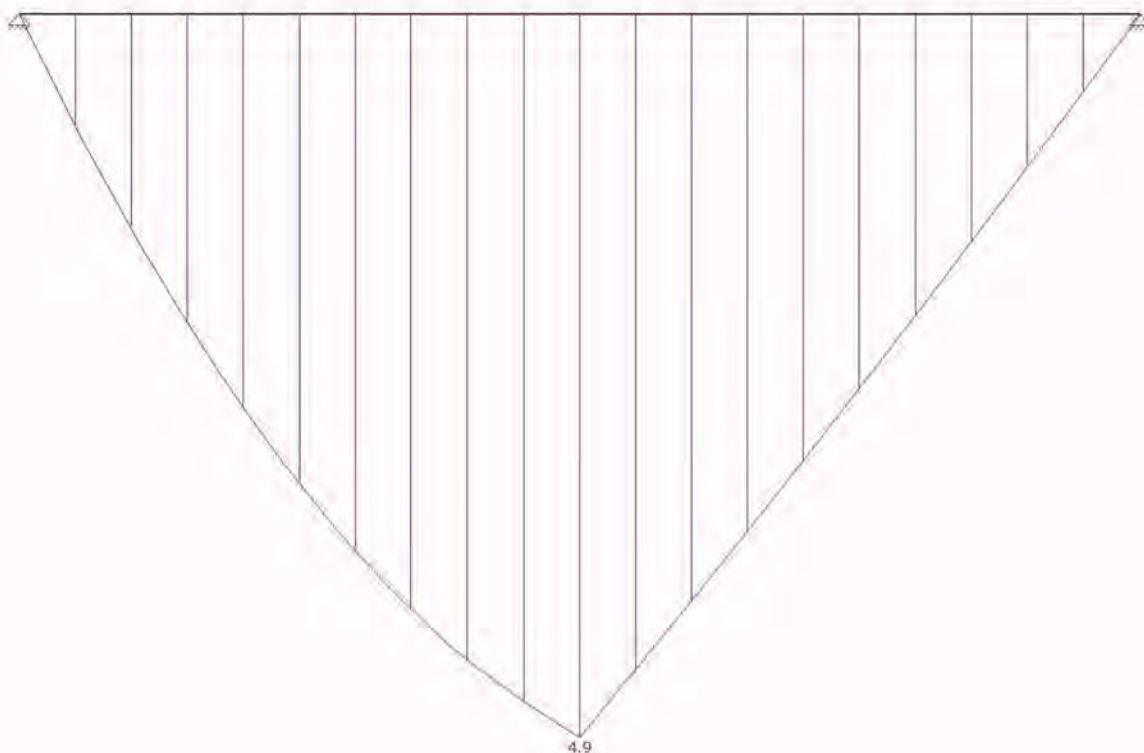

AFB. FU.C. DWARSKRACHT (VZ) OMHULLENDE

Fundamenteel Belastingscombinaties

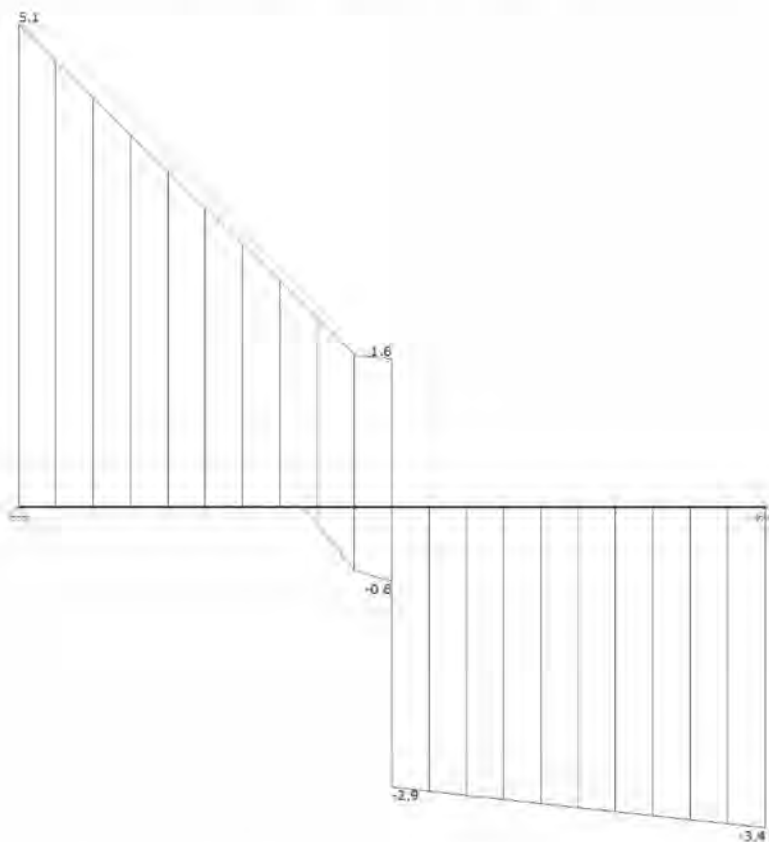

AFB. FU.C. OPLEGREACTIES OMHULLENDE

Fundamenteel Belastingscombinaties



AFB. KA.C. VERPLAATSINGEN OMHULLENDE

Karakteristiek Belastingscombinaties



AFB. HOUTCONTROLE

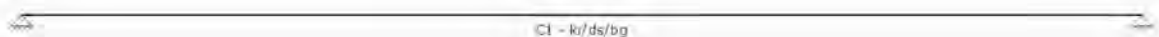

SAMENSTELLING CONSTRUCTIEDELEN

Constructiedeel	Staaft/staven
C1	S1

STABILITEITSGEGEVENS

Staaft	Profiel	Y-As (assenstelsel)			Z-As (assenstelsel)		
		Lsys Lkip/Lsys	Methode	Lkip	Lkip/Lsys	Methode	Lkip
C1 - V1 (0.000-3.100) 1.00	P3	3,100	Conservatief	3,100	1,00	Conservatief	3.100
-	-	geschoord m	-	geschoord m	-	geschoord m	-

KIPSTEUNENGEDEVENS

Staaft last	Profiel	Begin	Eind	Kipsteunen boven	Kipsteunen onder	Aangrijppunt
C1 - V1 (0.000-3.100)	P3	inklemming	inklemming			Neutraal
-	-	Volledig vast	Volledig vast	m	m	-

DOORBUIGINGGEGEVENS

Staaft w;2+w;3	Constr.type	Toetsingstype	Zeeg Y'	Zeeg Z'	Zeegvorm	w;max
C1 - V1 (0.000-3.100) L/500	Vloer	Scheurvorming	0	0	Parabolisch	L/250
-	-	gevoelige wanden	mm	mm	-	-

UNITY CHECK

Label	Toetsing	Combinatie	Artikel	UC max
C1	Doorsnede	Fu.C.2	NEN-EN1995-1-1#6.1.6 (6.11)	0,75
	Kip	Fu.C.2	NEN-EN1995-1-1#6.3.3 (6.33)	0,75
	Doorbuiging	Ka.C.2	NEN-EN1995#7.2 NEN-EN1990#A1.4.3(4)	0,55

8.19 Bijlage uitraai MatrixFrame berekening Pos 19

AFB. GEOMETRIE LIGGER

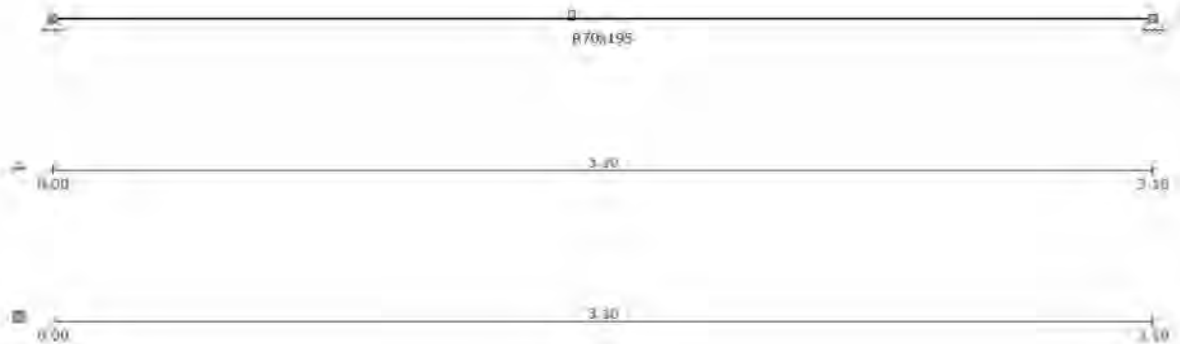

BALKGEOMETRIE

Positie	Profielnaam	5.1.2.e	Traagheidsmoment	Materiaal	E-Modulus	Uitzettingcoeff	
0,000 -	L(3,100)	R70x195	0	4.3253e-05	C24	1.1000e+07	50.0000e-07
0.06							
	m -			m4 -		kN/m2	Cϕm
	kN/m						

PROFIELVORMEN

Profiel	Verf. h.	hB	hE	tf	tw	tf2	B	bL	bR	Raatl.
P3	Nee	0,195	0,195	0,0000	0,0000	0,0000	0,070	0,000	0,000	Nee
-	-	m	m	m	m	m	m	m	m	m

MATERIALEN

Materiaalnaam	Poison	Dichtheid	E-Modulus	Uitzettingcoeff
C24	0.40	4.20	1.1000e+07	50.0000e-07
-	-	kN/m3	kN/m2	Cϕm

OPLEGGINGEN

Oplegging	Positie	Z	Yr
O1	0,000	Vast	Vrij
O2	L(3,100)	Vast	Vrij
-	m	kN/m	kNm/rad

BELASTINGSGEVALLEN TYPEN

Oplegg.	Staven	5.1.2.e	Gunstig/Ong.	Element	5.1.2.e	Psi0	Psi1	Cprob
Psi2	UGT/GGT							
B.G.1	Permanent	Permanent	-		N.v.t.	N.v.t.		
B.G.2	Verdeelde veranderlijke	Verdeelde	-	Cat. A) Vloeren	1	1	0.40	0.50
0.30	1,00/1,00							
	belasting	veranderlijke						
B.G.3	Geconcentreerde	Geconcentreerde	-	Cat. A) Vloeren	N.v.t.	N.v.t.	0.40	0.50
0.30								
	veranderlijke belasting	veranderlijke						
B.G.2.1	Verdeelde veranderlijke	Verdeelde	-	Cat. A) Vloeren	1	1	0.40	0.50
0.30	1,00/1,00							
	belasting (1)	veranderlijke						
		belasting						

AFB. LASTEN B.G.1 PERMANENT

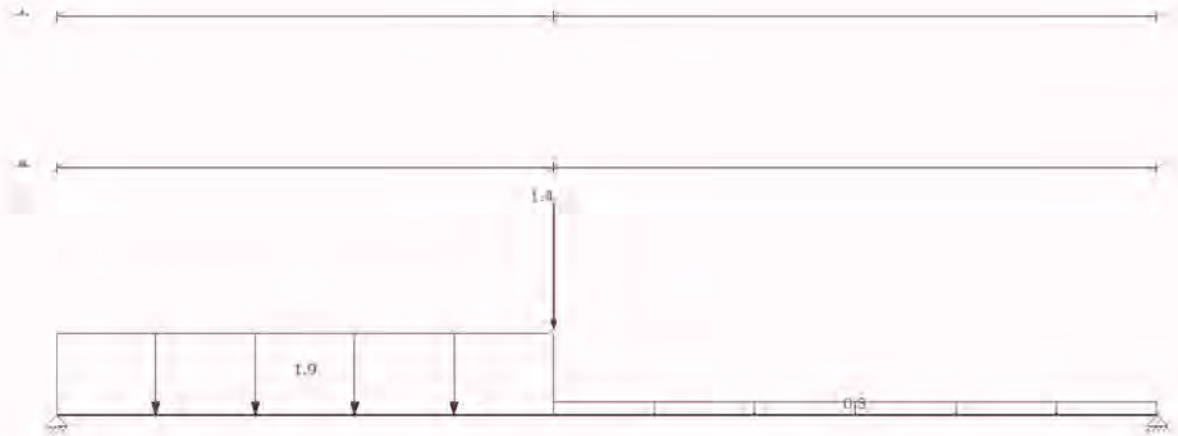

AFB. LASTEN B.G.2 VERDEELDE VERANDERLIJKE BELASTING

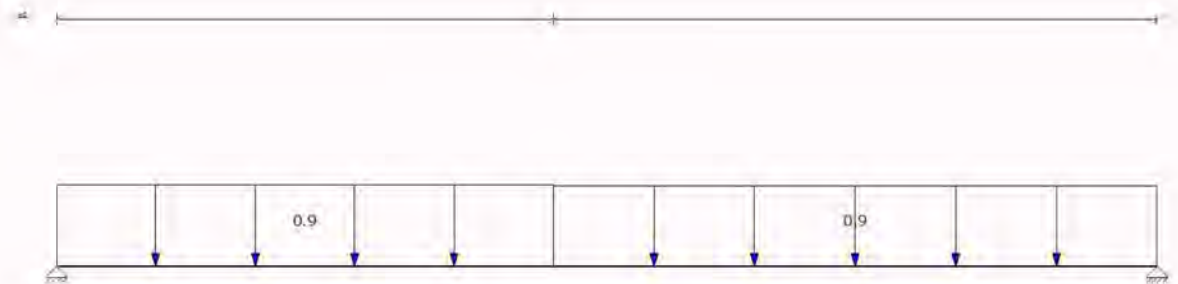

AFB. LASTEN B.G.3 GECONCENTREERDE VERANDERLIJKE BELASTING

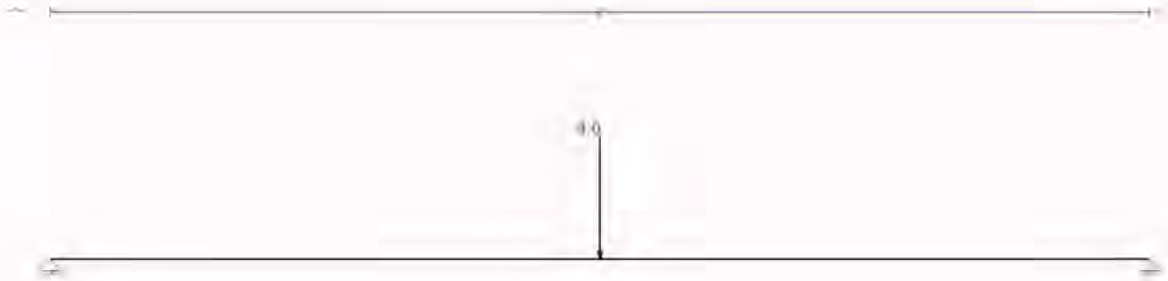

AFB. LASTEN B.G.2.1 VERDEELDE VERANDERLIJKE BELASTING (1)

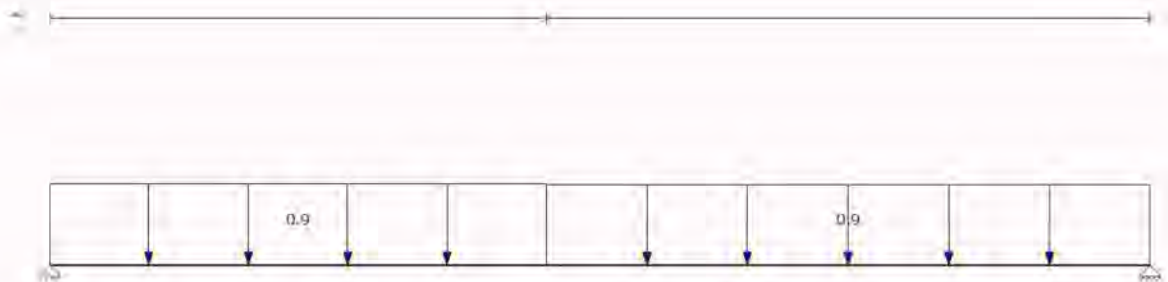

FUNDAMENTEEL BELASTINGSCOMBINATIES (TABEL)

B.G.	Omschrijving	Fu.C.1	Fu.C.2	Fu.C.3	Fu.C.4
B.G.1	Permanent	1.20	1.20	1.35	1.35
B.G.2	Verdeelde veranderlijke belasting	-	-	-	-
B.G.3	Geconcentreerde veranderlijke belasting	-	1.50	-	0.60
B.G.2.1	Verdeelde veranderlijke belasting (1)	1.50	-	0.60	-

KARAKTERISTIEK BELASTINGSCOMBINATIES (TABEL)

B.G.	Omschrijving	Ka.C.(w1)		Ka.C.1	Ka.C.2
B.G.1	Permanent	1.00	1.00	1.00	
B.G.2	Verdeelde veranderlijke belasting	-	-	-	
B.G.3	Geconcentreerde veranderlijke belasting	-	-	-	
B.G.2.1	Verdeelde veranderlijke belasting (1)	-	0.40	1.00	

FREQUENT BELASTINGSCOMBINATIES (TABEL)

B.G.	Omschrijving	Fr.C.(w1)	Fr.C.1
B.G.1	Permanent	1.00	1.00
B.G.2	Verdeelde veranderlijke belasting	-	-
B.G.3	Geconcentreerde veranderlijke belasting	-	-
B.G.2.1	Verdeelde veranderlijke belasting (1)	-	0.50

QUASI-PERMANENT BELASTINGSCOMBINATIES (TABEL)

B.G.	Omschrijving	Qu.C.1
B.G.1	Permanent	1,00
B.G.2	Verdeelde veranderlijke belasting	-
B.G.3	Geconcentreerde veranderlijke belasting	-
B.G.2.1	Verdeelde veranderlijke belasting (1)	0,30

UITGANGSPUNTEN VAN DE ANALYSE

Lineaire Elastische Analyse uitgevoerd

AFB. FU.C. MOMENT (MY) OMHULLENDE

Fundamenteel Belastingscombinaties

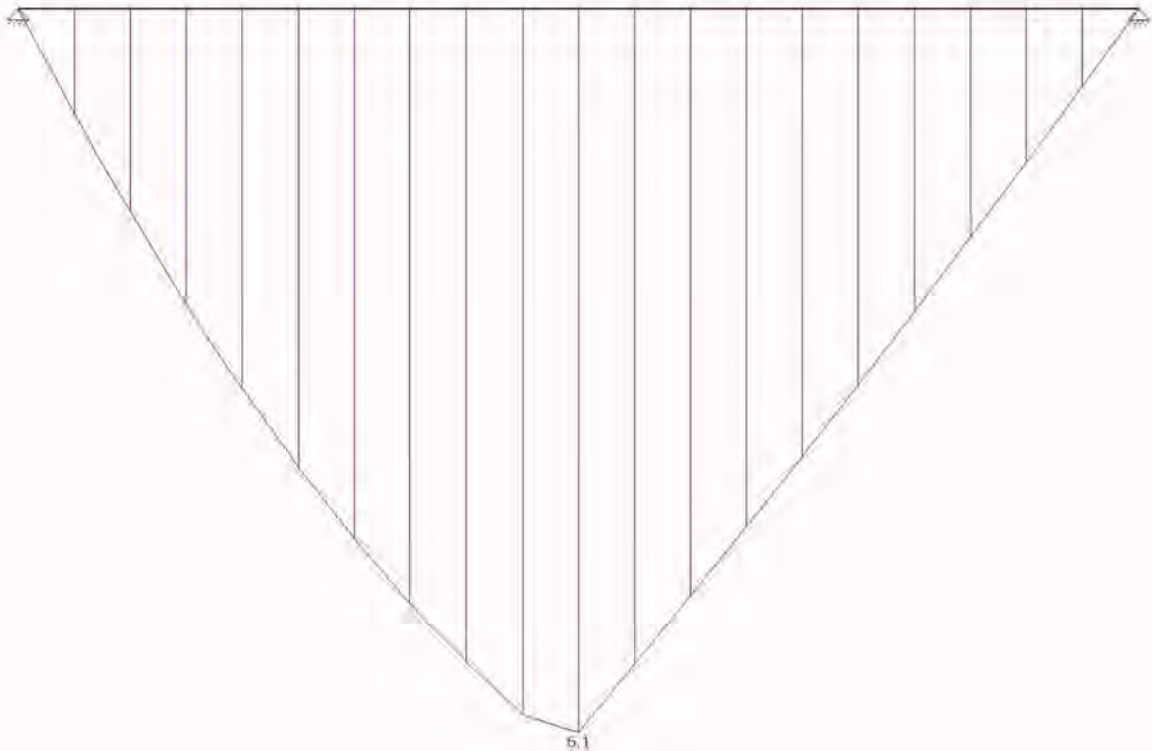

AFB. FU.C. DWARSKRACHT (VZ) OMHULLENDE

Fundamenteel Belastingscombinaties

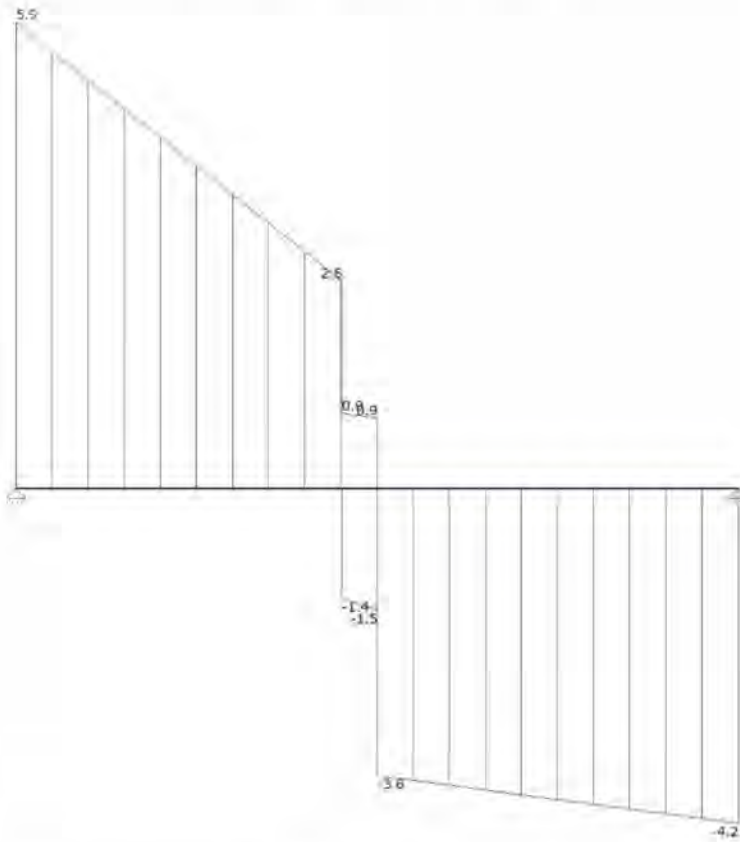

AFB, FU.C. OPLEGREACTIES OMHULLENDE

Fundamenteel Belastingscombinaties



AFB, KA.C. VERPLAATSINGEN OMHULLENDE

Karakteristiek Belastingscombinaties



AFB. HOUTCONTROLE



SAMENSTELLING CONSTRUCTIEDELEN

Constructiedeel	Staal/staven
C1	S1

STABILITEITSGEGEVENS

Staal	Profiel	Y-As (assenstelsel)			Z-As(assenstelsel)		
		Lsys Lkip/Lsys	Methode	Lkip	Lkip/Lsys	Methode	Lkip
C1 - V1 (0.000-3.100) 1.00	P3	3,100	Conservatief	3,100	1,00	Conservatief	3.100
-	-	geschoord m	-	geschoord m	-	geschoord m	-

KIPSTEUNENGEDEVENS

Staal last	Profiel	Begin	Eind	Kipsteunen boven	Kipsteunen onder	Aangrijppunt
C1 - V1 (0.000-3.100)	P3	inklemming	inklemming			Neutraal
-	-	Volledig vast	Volledig vast	m	m	-

DOORBUIGINGSGEGEVENS

Staal w;2+w;3	Constr.type	Toetsingstype	Zeeg Y'	Zeeg Z'	Zeegvorm	w;max
C1 - V1 (0.000-3.100) L/333	Vloer	Algemeen	0	0	Parabolisch	L/250
-	-	-	mm	mm	-	-

UNITY CHECK

Label	Toetsing	Combinatie	Artikel	UC max
C1	Doorsnede	Fu.C.2	NEN-EN1995-1-1#6.1.6 (6.11)	0,92
	Kip	Fu.C.2	NEN-EN1995-1-1#6.3.3 (6.33)	0,92
	Doorbuiging	Ka.C.2	NEN-EN1995#7.2 NEN-EN1990#A1.4.3(4)	0,77