

Voorgevel

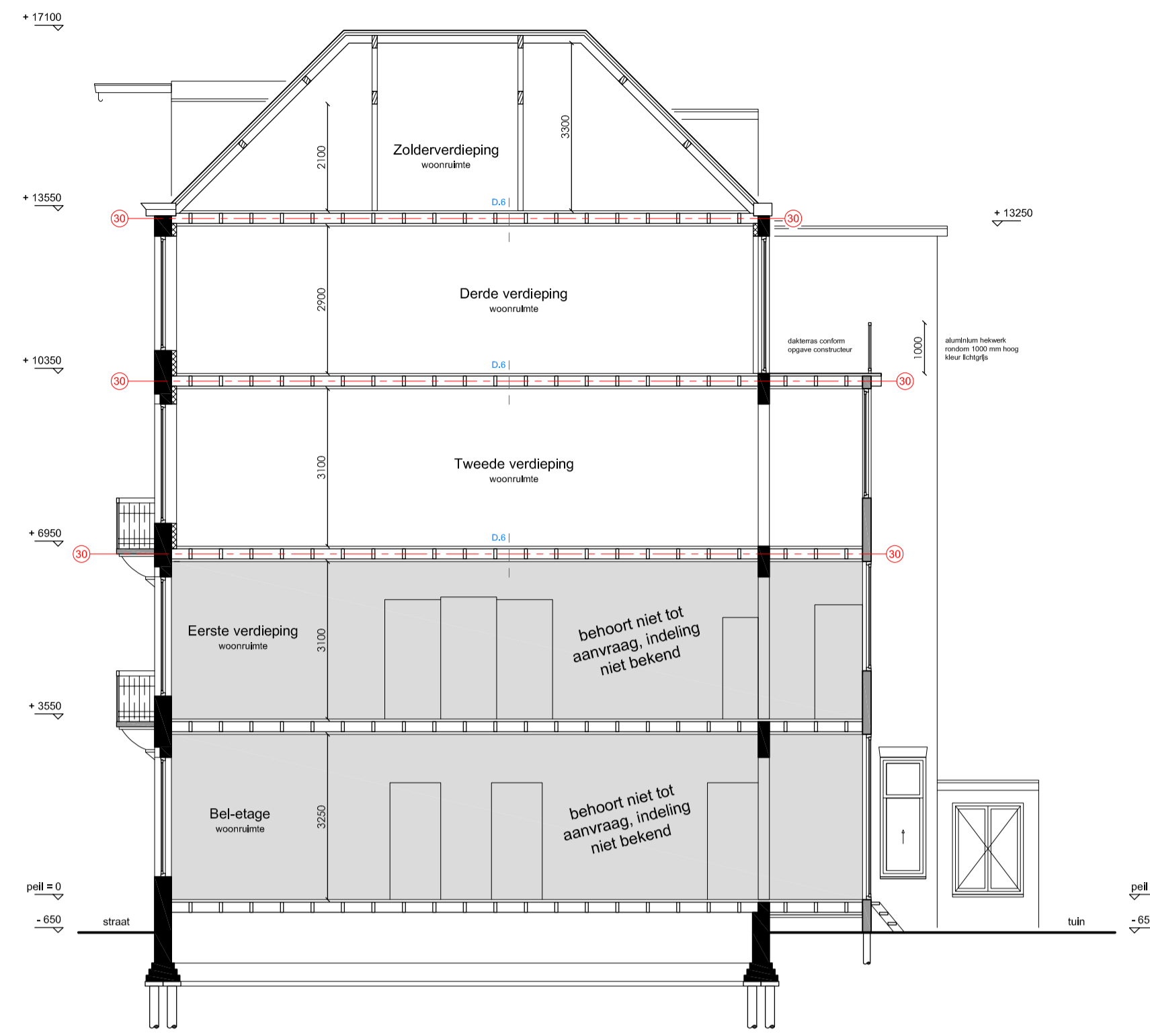

Doorsnede A-A

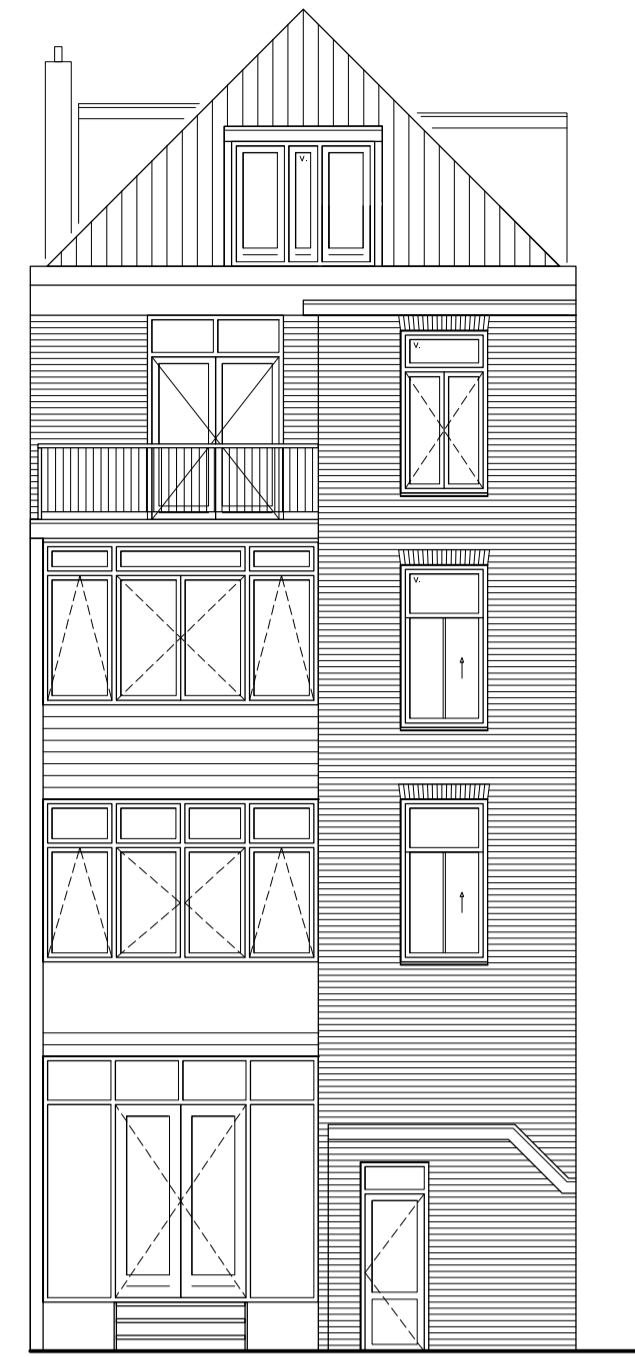

Achtergevel

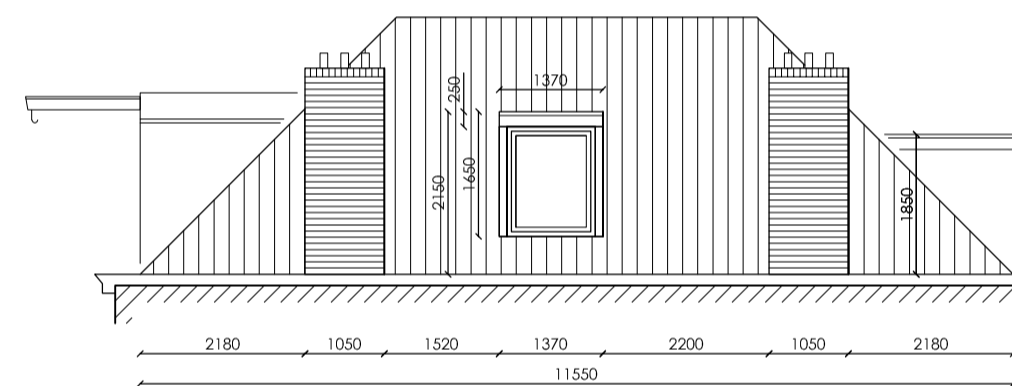

Rechter zijgevel

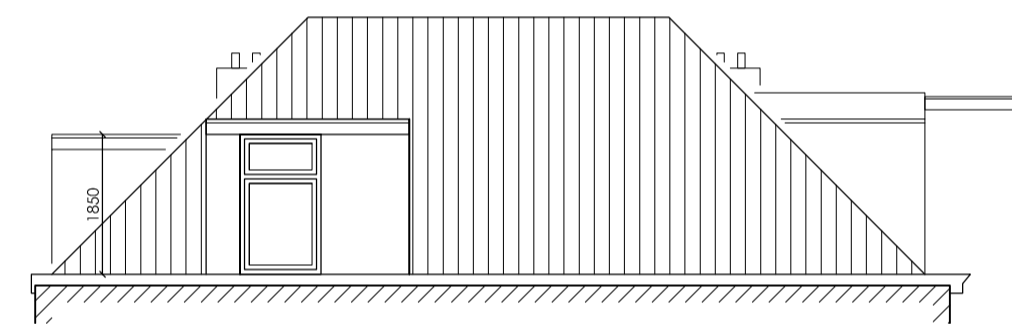

Linker zijgevel

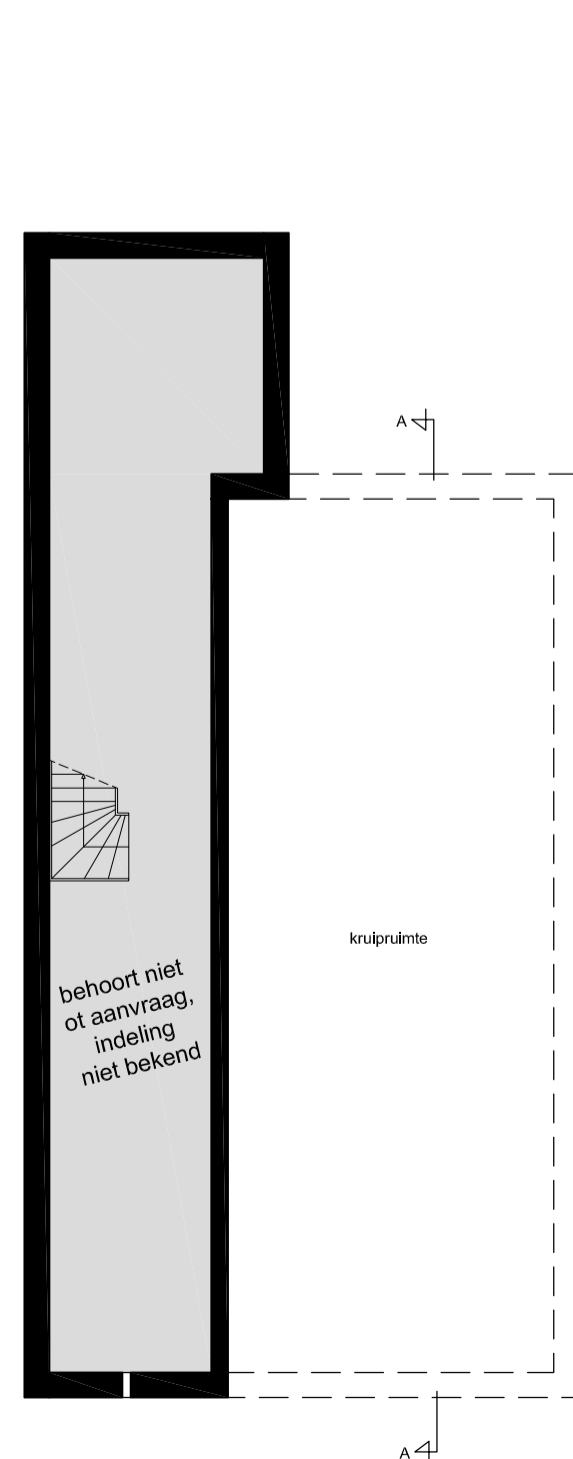

Souterrain

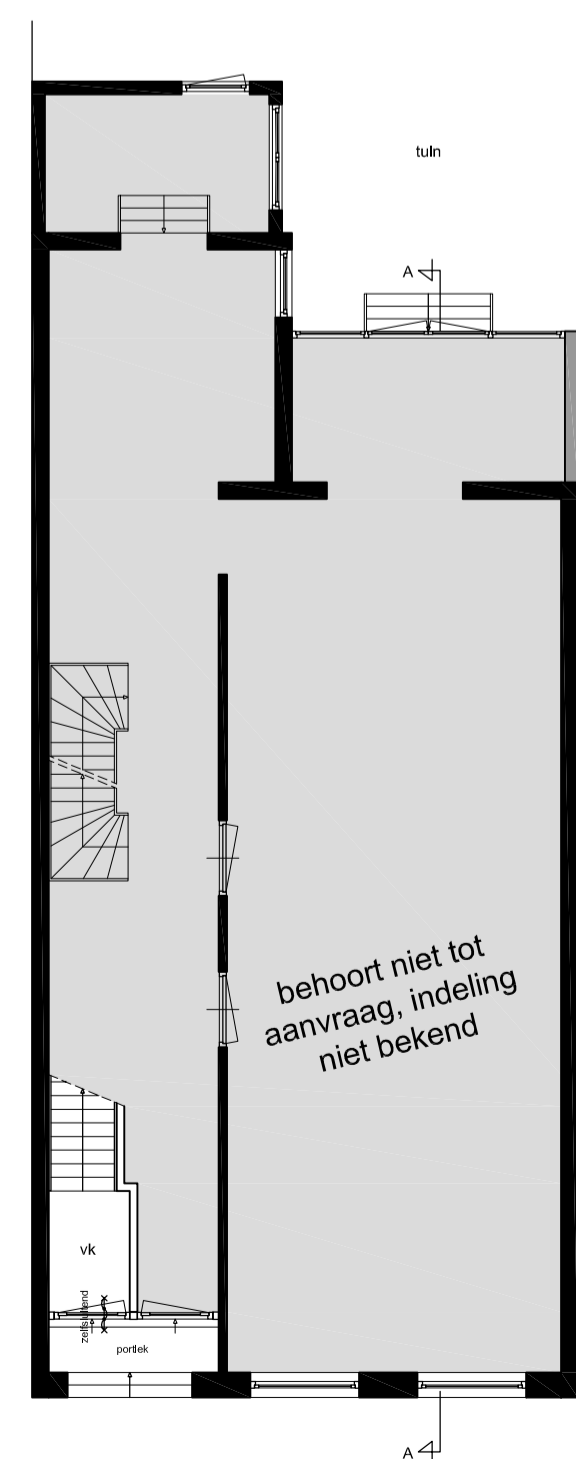

Bel-etage

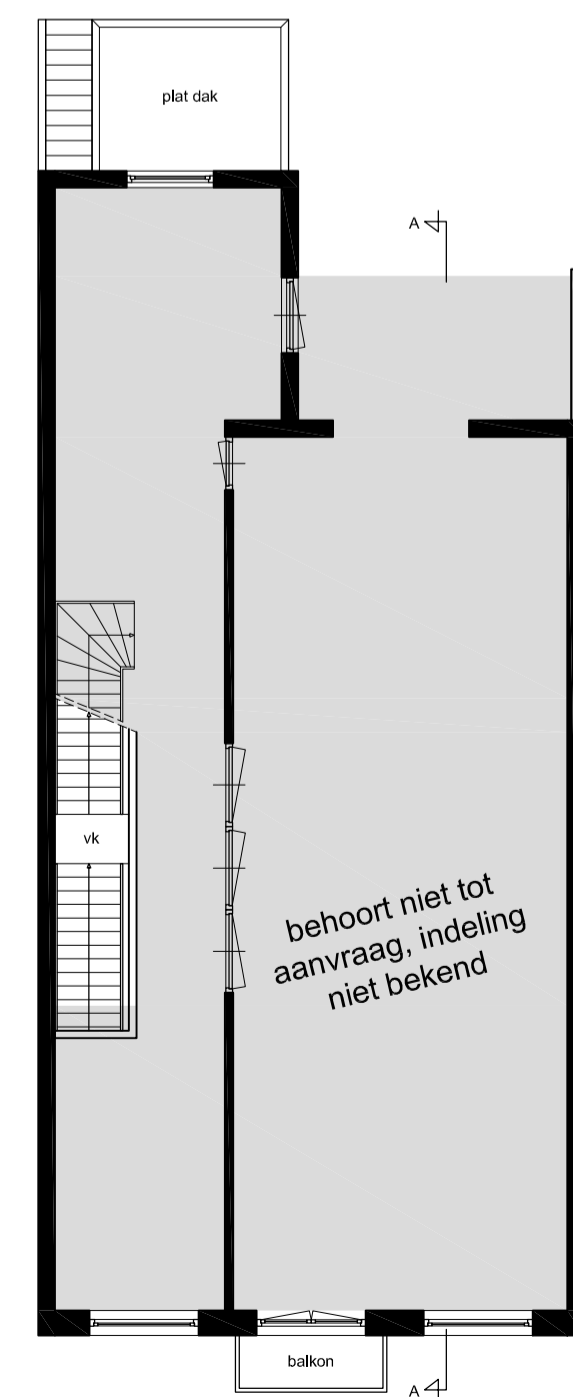

Eerste verdieping

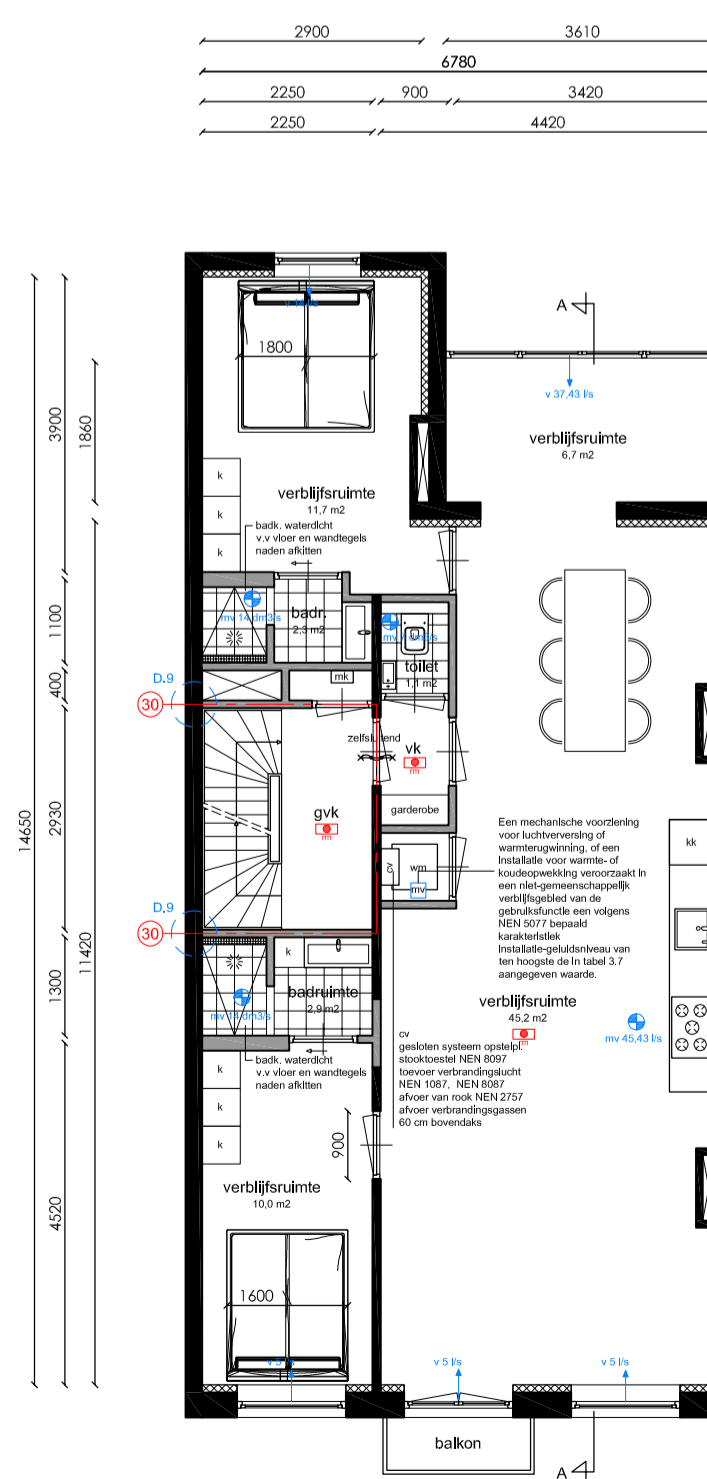

Tweede verdieping

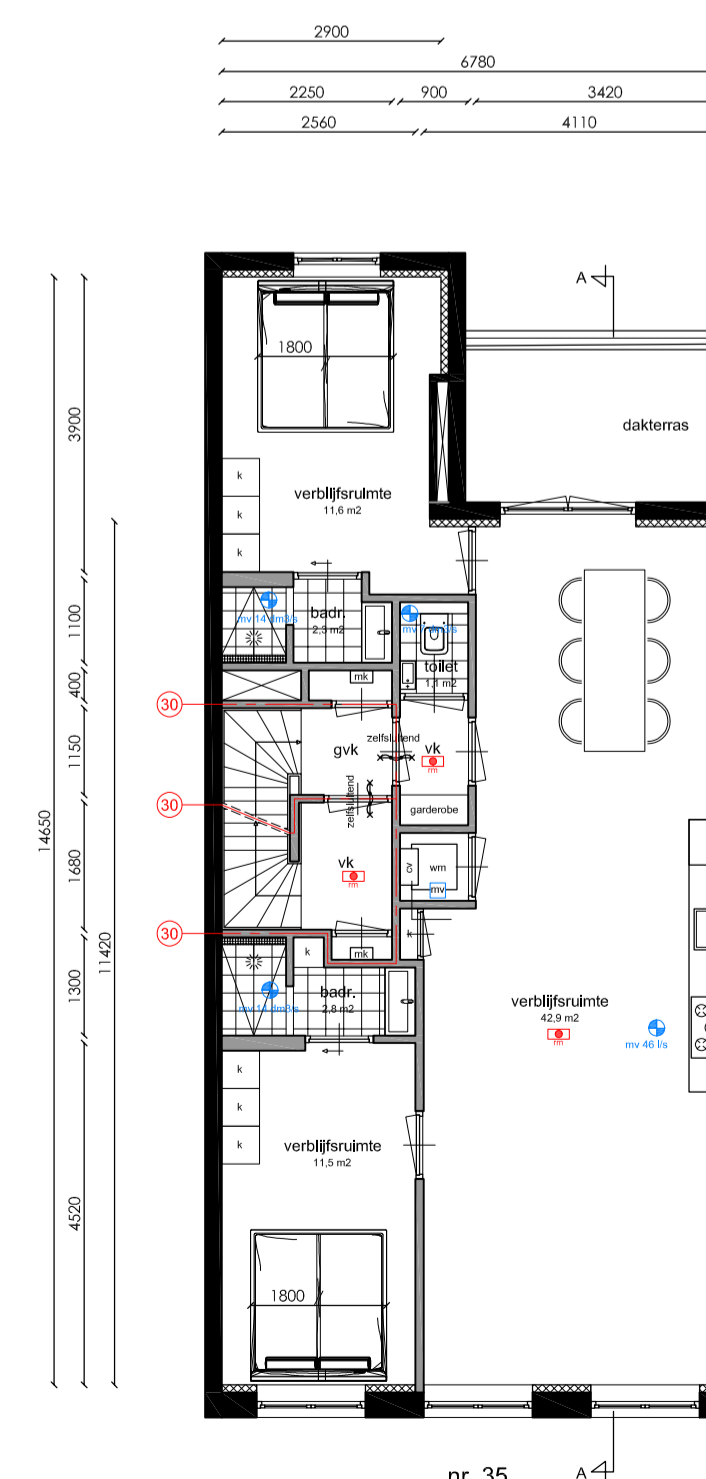

Derde verdieping

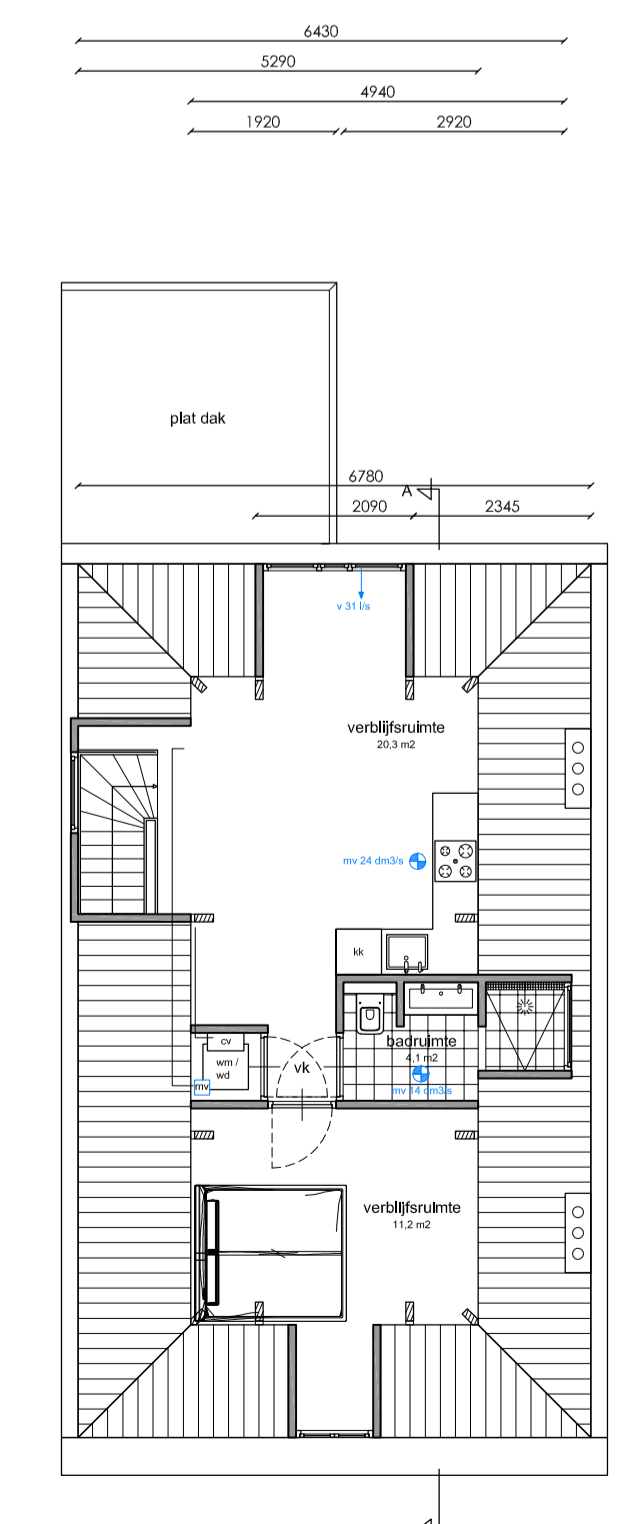

Zolderverdieping

RENOVOI		
afkorting	symbool	omschrijving
-	■	constructieve muren
sl	⊗	lichte scheidingswand
rg	⊗	standleiding
mv	⊗	rookgasafvoer & luchttoevoer
cv	⊗	mechanische ventilatie
gz	⊗	cv-ketel
mk	⊗	geizer
gas	⊗	meterkast
hwa	⊗	gasmeter
wm	⊗	hemelwaterafvoer
wd	⊗	wasmachine
kk	⊗	wasdroger
kt	⊗	koelkast
vk	⊗	kooktoestel
gwk	⊗	verkeersruimte
vr	⊗	gemeenschappelijke verkeersr. verbindingsruimte
rm	⊗	rookmelder op lichtnet volgens NEN 2555
WBDBO	⊗	weerstand branddoorslag en brandoverslag in minuten

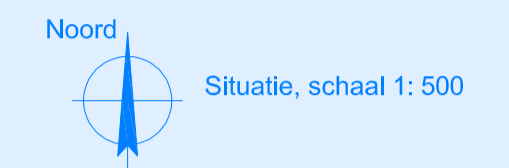
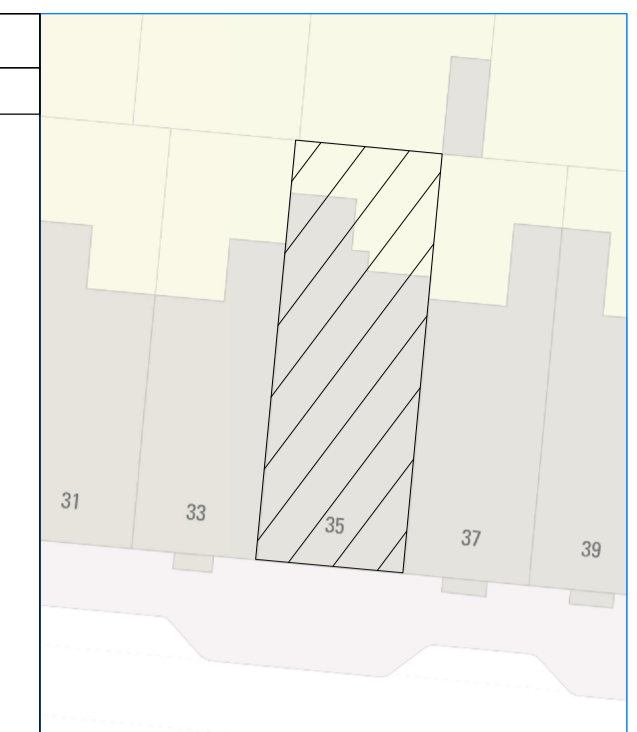

Project gegevens:
 Adres: 5.1, 2, e e
 Postcode: 1017 XX
 Gemeente: Amsterdam
 Gebied: Singelgrachtzone
 Monument: Nee
 Orde Pand: Orde 2

5.1, 2, e
 5.1, 2, e
 Amsterdam

Onderwerp: Bestaande toestand
 Fase: Splittingsaanvraag
 Datum: 16-02-2022
 Gewijzigd:
 Schaal: 1: 100
 Werknummer: 21081

Tek. nr: SB.1

