

Project **verbouwing bovenhuizen**

^{5.1, 2, e}
 5.1, 2, e Amsterdam

Opdrachtgever JEE Vastgoed BV
 Architect LINQ vastgoed adviseurs
 Onderdeel Statische berekening

Projectnummer **210936**

Datum 4 november 2021

Aantal pagina's 54

Opgesteld door ir. L. ^{5.1, 2, e} ^{5.1, 2, e}

Gecontroleerd door ir. ^{5.1, 2, e} ^{5.1, 2, e}

revisie	datum	omschrijving	door
A	12-01-2022	Wijziging staalconstructie tov 1 ^e verdieping	LR
B	15-02-2022	Aanpassing plan	KvA
C	18-02-2022	Wijziging plan	KvA
D	30-03-2022	Geen staal meer alleen hout constructies	KvA

INHOUDSOPGAVE

1	Algemene gegevens	3
1.1	Projectbeschrijving	3
1.2	Geldende voorschriften	5
1.2.1	Brandwerendheid	6
1.3	Gevolgklasse, betrouwbaarheidsklasse en belastingfactoren.....	7
1.3.1	Rekenwaarden van belastingen (STR/GEO) (Groep B)	7
1.3.2	Rekenwaarden van belastingen bruikbaarheidsgrenstoestand.....	8
1.4	Materialen.....	9
1.4.1	Staal	9
1.4.2	Hout	9
1.4.3	Metselwerk	9
1.5	Bijbehorende documenten	10
1.5.1	Tekeningen constructief.....	10
1.5.2	Tekeningen bouwkundig	10
2	Overzicht belastingen	11
2.1	Algemeen.....	11
2.2	Windbelasting.....	13
3	Houtconstructie	14
3.1	Dakbalklaag dakkapel	14
3.2	Balklaag dakterras zolderverdieping	16
3.3	Balklaag dakterras 3 ^e verdieping.....	18
3.4	Verankering baluster.....	20
3.5	Controle balklaag 4 ^e verd.....	22
3.6	Dragend hsb wand	30
3.7	Controle spant.....	33
3.8	Houten latei	46

Project 55.1, 2, e

Projectnummer 210936

Revisie D

IRg

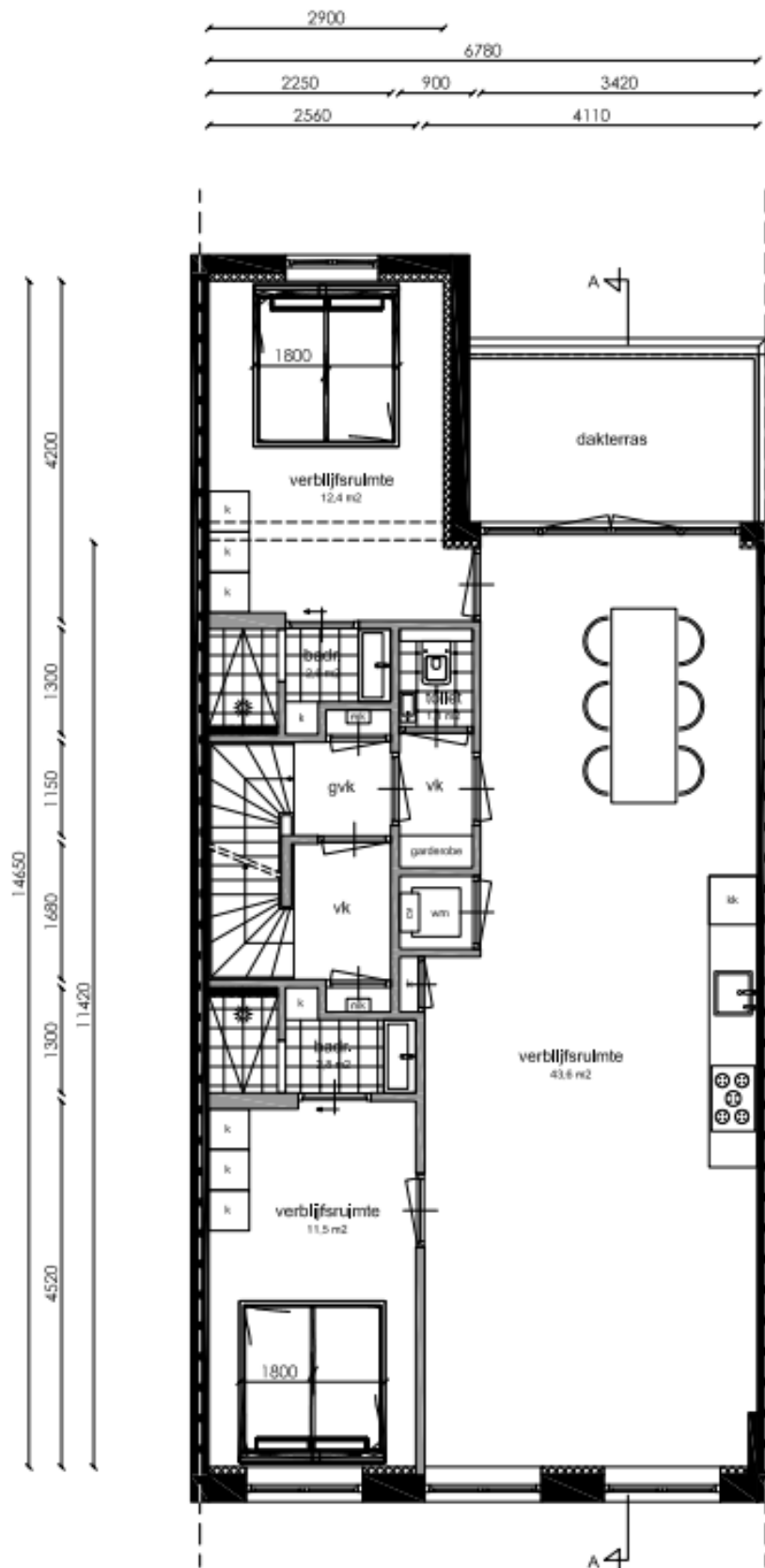

3^e verdieping nieuwe situatie

Project 5.1, 2, e
Projectnummer 210936
Revisie D



1.2 Geldende voorschriften

Eurocode 0: Grondslagen

NEN-EN 1990 Grondslagen van het constructief ontwerp

Eurocode 1: Belastingen op constructies

NEN-EN 1991-1-1 Volumieke gewichten, eigen gewicht, opgelegde belastingen

NEN-EN 1991-1-2 Belastingen bij brand

NEN-EN 1991-1-3 Sneeuwbelastingen

NEN-EN 1991-1-4 Windbelastingen

NEN-EN 1991-1-5 Thermische belastingen

NEN-EN 1991-1-7 Buitengewone belastingen

Eurocode 2: Betonconstructies

NEN-EN 1992-1-1 Algemene regels en regels voor gebouwen

NEN-EN 1992-1-2 Ontwerp en berekening van betonconstructies bij brand

Eurocode 3: Staalconstructies

NEN-EN 1993-1-1 Algemene regels en regels voor gebouwen

NEN-EN 1993-1-2 Staalconstructies bij brand

Eurocode 4: Staal- betonconstructies

NEN-EN 1994-1-1 Algemene regels en regels voor gebouwen

NEN-EN 1994-1-2 Staal- betonconstructies bij brand

Eurocode 5: Houtconstructies

NEN-EN 1995-1-1 Algemene regels en regels voor gebouwen

NEN-EN 1995-1-2 Houtconstructies bij brand

Eurocode 6: Constructies van metselwerk

NEN-EN 1996-1-1 Algemene regels voor constructies van gewapend en ongewapend metselwerk

NEN-EN 1996-1-2 Ontwerp en berekening van metselwerkconstructies bij brand

Eurocode 7: Geotechnisch ontwerp

NEN-EN 1997-1 Algemene regels

Bestaande bouw

NEN 8700 Grondslagen voor de beoordeling van de constructieve veiligheid van een bestaand bouwwerk

Bij alle voorschriften worden de laatste versies van de Nationale Bijlage (NB) gehanteerd.

Project 15.1, 2, e

Projectnummer 210936

Revisie D



1.2.1 Brandwerendheid

Voor het in stand houden van de rookvrije vluchtroutes geldt een minimale eis aan de constructie van 30 min.

De door het bouwbesluit gestelde minimale eisen aan de hoofddraagconstructie zijn:

hoogste vloer met een verblijfsgebied	: 13.5 m
functie	: Wonen
reductie toegestaan?	: Nee

Brandwerendheid (hoofddraagconstructie) : 60 min (bestaande bouw)

Deze brandwerendheid wordt bereikt door de constructie brandwerend te omkleden / schilderen / betongevulde profielen (met wapening) toe te passen.

In brandwerende scheidingen toegepaste constructie onderdelen dienen minimaal een brandwerendheid te hebben die overeenkomt met de eisen gesteld aan deze brandwerende scheiding.

Project 15.1, 2, e
 Projectnummer 210936
 Revisie D



1.3 Gevolgklasse, betrouwbaarheidsklasse en belastingfactoren

Ontwerplevensduur 50 jaar
 Ontwerplevensduurklasse 3
 Gevolgklasse CC2
 Betrouwbaarheidsklasse RC2

Belastingcategoriegrenzen en Ψ -factoren

Belasting	Ψ_0	Ψ_1	Ψ_2
Voorgescreven belastingen in gebouwen, categorie			
Categorie A: woon- en verblijfsruimtes	0,4	0,5	0,3
Categorie B: kantoorruimtes	0,5	0,5	0,3
Categorie C: bijeenkomstruimtes	0,6/0,4	0,7	0,6
Categorie D: winkelfuncties	0,4	0,7	0,6
Categorie E: opslagruimtes	1,0	0,9	0,8
Categorie F: verkeersruimte, voertuiggewicht ≤ 30 kN	0,7	0,7	0,6
Categorie G: verkeersruimte, 30 kN < voertuiggewicht ≤ 160 kN	0,7	0,5	0,3
Categorie H: Daken	0	0	0
Sneeuwbelasting	0	0,2	0
Windbelasting	0	0,2	0
Temperatuur (geen brand)	0	0,5	0

1.3.1 Rekenwaarden van belastingen (STR/GEO) (Groep B)

Blijvende en tijdelijke ontwerpsituaties	Blijvende belastingen		Overheersend veranderlijke belasting	Veranderlijke belastingen gelijktijdig	
	Ongunstig	Gunstig		Belangrijkste	Andere
(verg. 6.10a)	$1,35 G_{kj,sup}$	$0,9 G_{kj,inf}$			$1,5 \Psi_{0,i} Q_{k,i}$
(verg. 6.10.b)	$1,2 G_{kj,sup}$	$0,9 G_{kj,inf}$	$1,5 Q_{k,1}$		$1,5 \Psi_{0,i} Q_{k,i}$

Project

5.1.2 a
5.1, 2, e

Projectnummer

Revisie

D



1.3.2 Rekenwaarden van belastingen bruikbaarheidsgrenstoestand

Combinatie	<i>Blijvende belastingen</i>		<i>Veranderlijke belastingen</i>	
	Ongunstig	Gunstig	<i>Overheersende</i>	Andere
karacteristiek	$1,0 G_{kj,sup}$	$1,0 G_{kj,inf}$	$1,0 Q_{k,1}$	$1,0 \Psi_{0,i} Q_{k,i}$

Project 5.1, 2, e

Projectnummer 210936

Revisie D



1.4 Materialen

1.4.1 Staal

Staal kwaliteit IPE, HE-profielen	:	S235JRG2
Staal kwaliteit buizen	:	S355JRH
gelast	:	S355J2H
warmgewalst	:	S355J2H
Staal kwaliteit kokers	:	S275J0H
koudgevormd	:	S275J2H
warmgewalst	:	S275J2H
Staal kwaliteit geïntegreerde liggers	:	S355J2G3
Boutkwaliteit	:	8.8 Thermisch verzinkt
Ankerkwaliteit	:	4.6 Gerolde draad, met haak, tenzij anders vermeld

1.4.2 Hout

Houtkwaliteit	:	C 18/24 (bestaand/nieuw)
---------------	---	--------------------------

1.4.3 Metselwerk

Steenkwaliteit	:	Rode baksteen
Druksterkte (rekenwaarde)	:	2,0 N/mm ²

Project 15.1, 2, e

Projectnummer 210936

Revisie D



1.5 Bijbehorende documenten

1.5.1 Tekeningen constructief

210936-01D	verbouwing verdiepingen	30-03-2022
------------	-------------------------	------------

1.5.2 Tekeningen bouwkundig

	Tekeningen LINQ vastgoed adviseurs	01-09-2021
--	------------------------------------	------------

Project 55.1, 2, e

Projectnummer 210936

Revisie D



2 OVERZICHT BELASTINGEN

2.1 Algemeen

				kN/m ²
plat dak	g_k	dakhout en dakbalken		0,35
		plafond		0,15
		dakbedekking		0,10
		isolatie		0,05
				<hr/> 0,65
	q_k	$\psi_0 = 0,00$	extreem	1,00
schuin dak	g_k	dakhout en gordingen		0,65
		plafond		0,15
				<hr/> 0,80
		q_k	$\psi_0 = 0,00$	extreem
zolder	g_k	vloerhout en vloerbalken		0,25
		plafond		0,15
		afwerking		0,20
				<hr/> 0,60
		q_k	$\psi_0 = 0,40$	extreem scheidingswanden
3e verdieping	g_k	vloerhout en vloerbalken		0,25
		plafond		0,15
		afwerking		0,20
				<hr/> 0,60
		q_k	$\psi_0 = 0,40$	extreem scheidingswanden
2e verdieping	g_k	vloerhout en vloerbalken		0,25
		plafond		0,15
		afwerking		0,20
				<hr/> 0,60
		q_k	$\psi_0 = 0,40$	extreem scheidingswanden

Project 5.5.1, 2, e

Projectnummer 210936

Revisie D



1e verdieping	g_k	vloerhout en vloerbalken	0,25
		plafond	0,15
		afwerking	0,20
			<u>0,60</u>
	q_k	$\Psi_0 = 0,40$	extreem 1,75
			scheidingswanden 0,50
begane grond	g_k	vloerhout en vloerbalken	0,35
		afwerking	0,20
			<u>0,55</u>
	q_k	$\Psi_0 = 0,40$	extreem 1,75
			scheidingswanden 0,50
balkon	g_k	vloerhout en dakbalken	0,50
			<u>0,50</u>
	q_k	$\Psi_0 = 0,40$	extreem 2,50
dakterras	g_k	vloerhout en vloerbalken	0,25
		plafond	0,15
		afwerking	0,40
			<u>0,80</u>
	q_k	$\Psi_0 = 0,40$	extreem 2,50
d=110 baksteen	g_k		2,00
d=220 baksteen	g_k		4,00
d=330 baksteen	g_k		6,00
hsb wand	g_k		0,50
kozijnen	g_k		0,50

Project 5.5.1, 2, e
 Projectnummer 210936
 Revisie D



2.2 Windbelasting

Winddrukken en windkrachten

versie 2021-01

invoergegevens

gebouwhoogte	h	15 m
loodrecht op windrichting	b	14 m
parallel aan windrichting	d	6,5 m
	h/d	2,31
windgebied (I, II, III):		2
Bebouwd, Onbebouwd, Kust:		B
ontwerplevensduur	t	50 jaar
waarschijnlijkheidsfactor	C_{prob}	1,00 -
fundamentele		
basiswindsnelheid	$V_{b,o}$	27,0 m/s
basiswindsnelheid	V_b	27,0 m/s
ruwheidsfactor	C_{rz}	0,76 -
	Z_o	0,5 m
	Z_{min}	7 m
factor ruwheidslengte	k_r	0,22 -
gemiddelde windsnelheid	$V_{m(z)}$	20,5 m/s
turbulentie		
intensiteit	L_v	0,29

resultaten

extreme stuwdruk	$q_p(z_e)$	0,80 kN/m ²
Zone D		0,80
Zone E		-0,57
drukcoefficient (zone D+E)	C_{pe}	1,37
winddruk op buitenzijde	w_e	1,10 kN/m ²
bouwwerkfactor	$C_s C_d$	1
reductiefactor (EN1991-1-4)		0,85
windbelasting	$q_{p,k}$	0,93 kN/m ²

Project 5.1, 2, e
Projectnummer 210936
Revisie D



3 HOUTCONSTRUCTIE

3.1 Dakbalklaag dakkapel

Dak draagt af op dragende kozijn,

Technosoft Construct release 6.70a

4 nov 2021

Datum : 04/11/2021
Eenheden : kN/m/rad
Bestand : G:\Mijn
Drive\Projecten\2021\210936\Houtconstructie\
balklaag.cnw

Toegepaste normen volgens Eurocode met Nederlandse NB

Belastingen	NEN-EN 1990:2002	C2:2010	NB:2011 (nl)
	NEN-EN 1991-1-1:2002	C1:2009	NB:2011 (nl)
Hout	NEN-EN 1995-1-1:2005	A1:2011, C1:2006	NB:2013 (nl)
	NEN-EN 14080:2013		

Gording berekening. (H)

plattendak

Algemene gegevens

B x H	[mm] :	46 x 146	Sterkteklasse	:	C24
Overspanning	[mm] :	2300	Klimaatklasse	:	I
Aantal zijdl. steunen	:	-	Referentie periode [j]	:	50
Opleglengte	[mm] :	100			
Hoh in het dakvlak	[mm] :	600			
Helling	:	0.00			
Beschot sterkteklasse	:	C24			
Dikte beschot	[mm] :	12	$E_{0,mean} \times I$	[Nm ² /m] :	1584.0

Permanente belastingen G_{rep}

EG balklaag	:	0.35
Isolatie	:	0.05
Extra gewicht	:	0.25
Totaal [kN/m ²]	:	0.65

Veranderlijke belastingen

Q_k	[kN/m ²]	:	1.00
Q_k	[kN/m]	:	2.00
Q_k	[kN]	:	1.50
Q_k oppervlak	[m ²]	:	0.05 x 0.05
Reductiefactor	:		0.82

Project

5.5.1, 2, e

Projectnummer

210936

Revisie

D

IRg

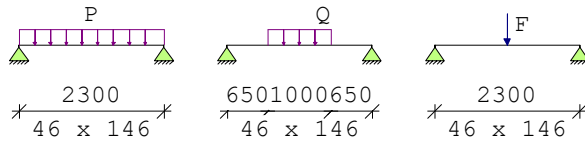

Belastingfactoren (NEN-EN 1990 - Bijlage A1.3)

Formule 6.10a: $\gamma_G : 1.35$ $\gamma_Q : 1.50$ Formule 6.10b: $\xi\gamma_G : 1.20$ $\gamma_Q : 1.50$

Partiële factor (Tabel 2.3 NEN-EN 1995-1-1)

 $\gamma_M [-] : 1.30$ **Stabiliteit**

1.Toetsing kipstabiliteit m.b.t. montagefase volgens par.6.3.3. is n.v.t.:
- u hebt het belastingsgeval 'Uitvoering' niet toegepast.

Resultaten (maatgevende combinaties)		eis	u.c.
Geconc. belasting	frm(6.13) $\tau_{v,d} = 0.53 < 2.46$ [N/mm ²]		0.21
Geconc. belasting	frm(6.3) $\sigma_{c,90,q,d} / (k_{c,90,q} * f_{c,90,d}) + \sigma_{c,90,F,d} / (k_{c,90,F} * f_{c,90,d}) < 1.00$ $= 0.12 / 1.54 + 0.49 / 2.31 = 0.29$		0.29
Lijnlast	frm(6.11) $\sigma_{m,y,d} = 10.15 < 14.85$ [N/mm ²]		0.68
Lijnlast	$u_{bij} = 4.19 < 9.20$ [mm]		0.46
Lijnlast	$u_{net,fin} = 5.27 < 9.20$ [mm]		0.57

Project **5.1, 2, e**
 Projectnummer 210936
 Revisie D

3.2 Balklaag dakterras zolderverdieping

Balklaag wordt aangenomen als 80*180/600mm (in het werk te controleren)

Balklaag voldoet.

Technosoft Construct release 6.70a

4 nov 2021

Datum : 04/11/2021
 Eenheden : kN/m/rad
 Bestand : G:\Mijn
 Drive\Projecten\2021\210936\Houtconstructie\
 balklaag.cnw

Toegepaste normen volgens Eurocode met Nederlandse NB

Belastingen	NEN-EN 1990:2002	C2:2010	NB:2011 (nl)
	NEN-EN 1991-1-1:2002	C1:2009	NB:2011 (nl)
Hout	NEN-EN 1995-1-1:2005	A1:2011, C1:2006	NB:2013 (nl)
	NEN-EN 14080:2013		

Balklaag berekening. (H)

Algemene gegevens

B x H [mm]	: 80 x 180	Sterkteklasse	: C18
Overspanning [mm]	: 3000	Klimaatklasse	: I
Opleglengte [mm]	: 100	Referentie periode [j]	: 50
H.o.h. afstand [mm]	: 600	Min. eigenfreq. [Hz]	: 3
Beschot sterkteklasse:	C24		
Dikte beschot [mm]	: 12	$E_{0,mean} \times I$ [Nm ² /m]	: 1584

Permanente belastingen

G_{rep}

EG balklaag	: 0.25
Extra belasting	: 0.55
Totaal [kN/m ²]	: 0.80

Veranderlijke belastingen

$Q_k + P_{wanden}$ [kN/m ²]	: 2.50 = 2.50 + 0.00
Ψ_0 [-]	: 0.40
Ψ_2 [-]	: 0.30
Q_k [kN]	: 3.00
Q_k oppervlak [m ²]	: 0.05 x 0.05
Reductiefactor	: 0.82

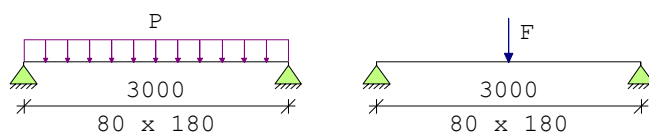

Belastingfactoren (NEN-EN 1990)

Formule 6.10a: γ_G : 1.35 γ_Q : 1.50

Project 55.1, 2, e

Projectnummer 210936

Revisie D



Formule 6.10b: $\xi\gamma_G : 1.20$ $\gamma_Q : 1.50$

Partiële factor (Tabel 2.3 NEN-EN 1995-1-1)

$\gamma_M [-]: 1.30$

Meegenomen combinaties in de berekening :	$k_{mod} [-]$	$b_{ef} [mm]$	$k_{c,90,q}$
$k_{c,90,F}$			
* Perm. + q-last (6.10a) ($G_{rep} + Q_k$)	0.80	80	1.00
* Perm. + q-last (6.10b) ($G_{rep} + Q_k$)	0.80	80	1.00
* Perm. + puntlast (6.10a) ($G_{rep} + Q_k$)	0.80	80	1.00
1.00			
* Perm. + puntlast (6.10b) ($G_{rep} + Q_k$)	0.80	80	1.00
1.00			

Resultaten (maatgevende combinaties)

eis

u.c.

Perm + plast(6.10b) frm(6.11) $\sigma_{m,y,d} = 7.84 < 11.08 [N/mm^2]$ 0.71
Perm + plast(6.10b) frm(6.13) $\tau_{v,d} = 0.52 < 2.09 [N/mm^2]$ 0.25
Perm + plast(6.10b) frm(6.3) $\sigma_{c,90,q,d} / (k_{c,90,q} * f_{c,90,d}) +$
 $\sigma_{c,90,F,d} / (k_{c,90,F} * f_{c,90,d}) < 1.00$
 $= 0.11 / 1.35 + 0.55 / 1.35 = 0.49$

Verdeelde belasting $u_{bij} = 6.20 < 9.00 [mm]$ 0.69
Verdeelde belasting $u_{net,fin} = 7.65 < 12.00 [mm]$ 0.64

Resonantie : eerste eigen frequentie = $9.84 > 3.00 [Hz]$ 0.30

Opmerking : Eigen frequentie is groter dan 8 Hz. Toetsing volgens EN 1995-1-1

art. 7.3.3(2) is noodzakelijk.

3.3 Balklaag dakterras 3^e verdieping

Balklaag wordt aangenomen als 75*175 / 600mm. In het werk te controleren.

Balklaag voldoet

Technosoft Construct release 6.70a

4 nov 2021

Datum : 04/11/2021
 Eenheden : kN/m/rad
 Bestand : G:\Mijn
 Drive\Projecten\2021\210936\Houtconstructie\
 balklaag.cnw

Toegepaste normen volgens Eurocode met Nederlandse NB

Belastingen	NEN-EN 1990:2002	C2:2010	NB:2011 (nl)
	NEN-EN 1991-1-1:2002	C1:2009	NB:2011 (nl)
Hout	NEN-EN 1995-1-1:2005	A1:2011, C1:2006	NB:2013 (nl)
	NEN-EN 14080:2013		

Balklaag berekening. (H)**Algemene gegevens**

B x H	[mm] : 75 x 175	Sterkteklasse	:	C18
Overspanning	[mm] : 3500	Klimaatklasse	:	I
Opleglengte	[mm] : 100	Referentie periode [j]	:	50
H.o.h. afstand	[mm] : 600	Min. eigenfreq. [Hz]	:	3
Beschot sterkteklasse:	C24			
Dikte beschot	[mm] : 12	$E_{0,mean} \times I$	[Nm ² /m] :	1584

Permanente belastingen

G_{rep}

EG balklaag	:	0.08
Extra belasting	:	0.55
Totaal [kN/m ²]	:	0.63

Veranderlijke belastingen

$Q_k + P_{wanden}$	[kN/m ²] :	2.50 = 2.50 + 0.00
Ψ_0	[-] :	0.40
Ψ_2	[-] :	0.30
Q_k	[kN] :	3.00
Q_k oppervlak	[m ²] :	0.05 x 0.05
Reductiefactor	:	0.82

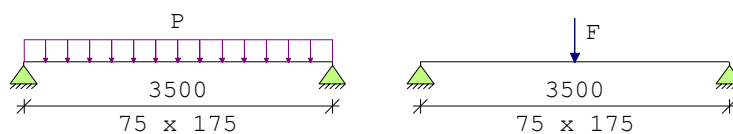

Belastingfactoren (NEN-EN 1990)

Formule 6.10a: γ_G : 1.35 γ_Q : 1.50

Project

5.1, 2, e

Projectnummer

210936

Revisie

D



Formule 6.10b: $\xi_{\gamma_e} : 1.20 \quad \gamma_Q : 1.50$

Partiële factor (Tabel 2.3 NEN-EN 1995-1-1)

$\gamma_M [-]: 1.30$

Meegenomen combinaties in de berekening :	$k_{mod} [-]$	$b_{ef} [mm]$	$k_{c, 90, q}$
$k_{c, 90, F}$			
* Perm. + q-last (6.10a) ($G_{rep} + Q_k$)	0.80	75	1.00
* Perm. + q-last (6.10b) ($G_{rep} + Q_k$)	0.80	75	1.00
* Perm. + puntlast (6.10a) ($G_{rep} + Q_k$)	0.80	75	1.00
1.00			
* Perm. + puntlast (6.10b) ($G_{rep} + Q_k$)	0.80	75	1.00
1.00			

Resultaten (maatgevende combinaties)

eis

u.c.

Perm + qlast(6.10b) frm(6.11)	$\sigma_{m, y, d} = 10.83 < 11.08 [N/mm^2]$	0.98
Perm + plast(6.10b) frm(6.13)	$\tau_{v, d} = 0.57 < 2.09 [N/mm^2]$	0.27
Perm + plast(6.10b) frm(6.3)	$\sigma_{c, 90, q, d} / (k_{c, 90, q} * f_{c, 90, d}) +$ $\sigma_{c, 90, F, d} / (k_{c, 90, F} * f_{c, 90, d}) < 1.00$ $= 0.11 / 1.35 + 0.59 / 1.35 = 0.51$	
Verdeelde belasting	$u_{bij} = 12.95 < 10.50 [mm]$	<u>1.23</u>
Verdeelde belasting	$u_{net, fin} = 15.41 < 14.00 [mm]$	<u>1.10</u>
Resonantie : eerste eigen frequentie	$= 7.04 > 3.00 [Hz]$	0.43

3.4 Verankering baluster

In onderstaande een berekening van de verankering van de baluster aan de houten balklaag. De baluster zelf is volgens opgave leverancier.

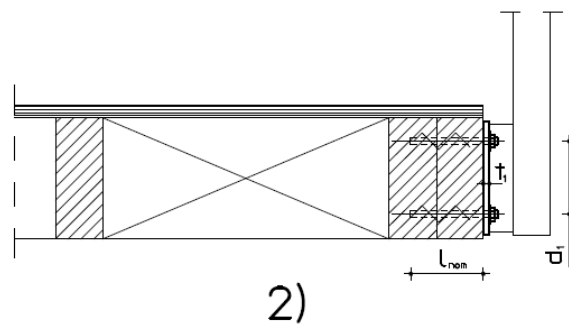
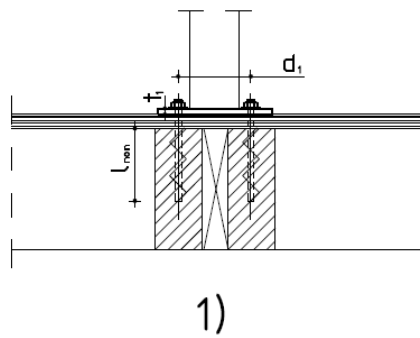

Twee varianten voor verankering van het hekwerk.

Project 55.1, 2, e
 Projectnummer 210936
 Revisie D



Staal- op houtverbinding met houtdraadbouten

versie 2019-01

invoergegevens

rekenwaarde stootbelasting	F_d	1,5 kN
hoogte aanstootpunt	h_1	1 m
buigend moment	M_d	1,5 kNm
afstand	d_1	120 mm
axiale belasting	$F_{ax;Ed}$	12,5 kN
belastingduurklasse		2
modificatiefactor	k_{mod}	0,8
volumieke massa	ρ	350 kg/m ³
materiaalfactor	γ_m	1,3
grensspanning houtdraadbout	f_u	400 N/mm ²
boutdiameter	d_{nom}	10 mm
aantal	n	2
verankeringslengte	l_{nom}	60 mm
materiaalfactor	γ_m	1,3
hoek met vezelrichting	α	90 gr
minimale balkbreedte [$\geq 8d$]	b_1	80
effectief aantal	n_{ef}	1,9
effectieve verankeringslengte	l_{ef}	48 mm

resultaten

$$f_{ax,\alpha,k} = \frac{f_{ax,k}}{\sin^2 \alpha + 1,5 \cos^2 \alpha}$$

$$f_{ax;\alpha;k} \quad 21,4 \text{ N/mm}$$

$$F_{ax,\alpha,Rk} = n_{ef} (\pi d l_{ef})^{0,8} f_{ax,\alpha,k}$$

rekenwaarde uittreksterkte	$F_{ax;Rd}$	13,9 kN
----------------------------	-------------	----------------

toetsing van de verbinding

gecombineerde toetsing voor belasting in dwarsrichting en axiale belasting	$\frac{F_{ax,Ed}}{F_{ax,Rd}} \leq 1$
--	--------------------------------------

$$\frac{UC}{0,90}$$

Project

5.1, 2, e
5.1, 2, e

Projectnummer

210936

Revisie

D



3.5 Controle balklaag 4^e verd.

Opdrachtgever heeft aangegeven dat de vloer veert en deze wil verstijven. De huidige afmeting van de balklaag is 70x220 hoh.900mm. Deze balklaag voldoet niet en dient enkel verstijft te worden met 1x50*220 of 2x35*220 in de brede beuk.

q3

	ψ_0	breedte	lengte	kN/m ²	kN/m ¹		kN/m ²	kN/m ¹
3e verdieping	1	0.90	1.00	0.60	<u>0.54</u>	extr.	2.25	<u>2.03</u>
				$G_k =$	0.5		$q_k =$	2.0

q4

	ψ_0	breedte	lengte	kN/m ²	kN/m ¹		kN/m ²	kN/m ¹
badkamer	1	0.90	1.00	1.50	<u>1.35</u>	extr.	2.25	<u>2.03</u>
				$G_k =$	1.4		$q_k =$	2.0

Project 5.1, 2, e

Projectnummer 210936

Revisie D



Technosoft Raamwerken release 6.73b

15 feb 2022

Project.....: 210936
Onderdeel.....: Controle bestaande balklaag
Constructeur.: Kaj
Dimensies.....: kN;m;rad (tenzij anders aangegeven)
Datum.....: 15/02/2022
Bestand.....: G:\Mijn
Drive\Projecten\2021\210936\Houtconstructie\210936 -
controle balklaag 4e verd..rww

Belastingbreedte.: 0.900
Rekenmodel.....: 2e-orde-elastisch.
Theorieën voor de bepaling van de krachtsverdeling:
1) Uiterste grenstoestand:
Geometrisch niet lineair alle staven.
Fysisch lineair alle staven.
2) Gebruiksgrenstoestand:
Lineaire-elasticiteitstheorie

Maximum aantal iteraties.....: 50
Max.deellengte kolommen/wanden: 0.500 Max.deellengte balken/vloeren: 0.500
Max. X-verplaatsing in UGT.....: 0.500 Max. Z-verplaatsing in UGT...: 0.250

Gunstige werking van de permanente belasting wordt automatisch verwerkt.

Belastingfactoren zijn bepaald conform NEN8700:2011
Tabel A1.2(B) en (C): Factoren bij verbouw.
Factoren ten behoeve van Bouwbesluit 2003 of daarvoor.

Toegepaste normen volgens Eurocode met Nederlandse NB

Belastingen	NEN-EN 1990:2002	C2:2010,A1:2019	NB:2019(nl)
	NEN-EN 1991-1-1:2002	C1/C11:2019	NB:2019(nl)
	NEN 8700:2011		
Hout	NEN-EN 1995-1-1:2005	A1:2011,C1:2006	NB:2013(nl)

GEOMETRIE

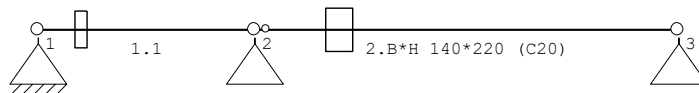

MATERIALEN

Mt	Kwaliteit	E-modulus[N/mm ²]	S.G.	S.G.verhoogd	Pois.	Uitz. coëff
1	C18	9000	3.2	3.8	1.00	5.0000e-06
2	C20	9500	3.3	4.0	1.00	5.0000e-06
3	C22	10000	3.4	4.1	1.00	5.0000e-06

Bij de bepaling v.h. e.g. van houten staven is de S.G.verhoogd toegepast.

PROFIELEN [mm]

Prof.	Omschrijving	Materiaal	Oppervlak	Traagheid	Vormf.
1	B*H 70*220	1:C18	1.5400e+04	6.2113e+07	0.00
2	B*H 140*220	2:C20	3.0800e+04	1.2423e+08	0.00
3	B*H 210*220	3:C22	4.6200e+04	1.8634e+08	0.00

PROFIELEN vervolg [mm]

Prof.	Staaftype	Breedte	Hoogte	e	Type	b1	h1	b2	h2
1	0:Normaal	70	220	110.0	0:RH				
2	0:Normaal	140	220	110.0	0:RH				
3	0:Normaal	210	220	110.0	0:RH				

Project

5.1, 2, e

Projectnummer

210936

Revisie

D

IRg

Project.....: 210936

Onderdeel.....: Controle bestaande balklaag

PROFIELVORMEN [mm]

1 B*H 70*220



2 B*H 140*220



3 B*H 210*220

**KNOPEN**

Knoop	X	Z
1	0.000	0.000
2	2.300	0.000
3	6.800	0.000

STAVEN

St.	ki	kj	Profiel	Aansl.i	Aansl.j	Lengte Opm.
1	1	2	1:B*H 70*220	NDM	NDM	2.300
2	2	3	2:B*H 140*220	ND-	NDM	4.500

VASTE STEUNPUNTEN

Nr.	knoop	Kode	XZR	l=vast	0=vrij	Hoek
1	1	110				0.00
2	2	010				0.00
3	3	010				0.00

BELASTINGGENERATIE ALGEMEEN.

Betrouwbaarheidsklasse.....: 2 Referentieperiode.....: 50
 Gebouwdiepte.....: 0.00 Gebouwhoogte.....: 0.00
 Niveau aansl.terrein.....: 0.00 E.g. scheid.w. [kN/m2]: 0.00

STAAFTYPEN

Type	staven
1:Vloer.	: 1,2

LASTVELDEN

Veranderlijke belastingen door personen

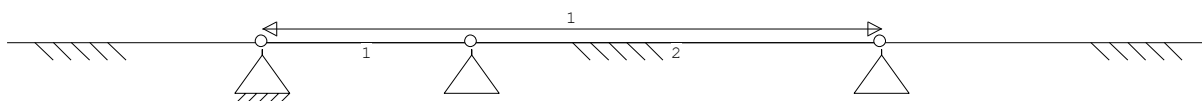
**LASTVELDEN**

Nr	Staaft	Tabel	Klasse-Gebruiksfunctie	Verd.	q _k	Q _k	F _t /F _{t0}
1	1-2	6.2	A-Vloeren	0	-2.25*	-3.00	1.00

Opmerkingen

[*] Deze belasting is door de gebruiker gewijzigd

BELASTINGGEVALLEN

B.G.	Omschrijving	Type
1	Permanente belasting EGZ=-1.00	1
g	2 Ver. bel. pers. ed. (q _k)	2
g	3 Ver. bel. pers. ed. (Q _k)	3

g = gegenereerd belastinggeval

Project

5.1, 2, e

Projectnummer

210936

Revisie

D



Project.....: 210936

Onderdeel.....: Controle bestaande balklaag

BELASTINGGEVALLEN vervolg

B.G.	Omschrijving	Belastingduurklasse
1	Permanente belasting	Blijvend
2	Ver. bel. pers. ed. (q_k)	Middellang
3	Ver. bel. pers. ed. (Q_k)	Middellang

BELASTINGEN

B.G:1

Permanente belasting

Eigen gewicht van alle staven is meegenomen in berekening. Richting:↓

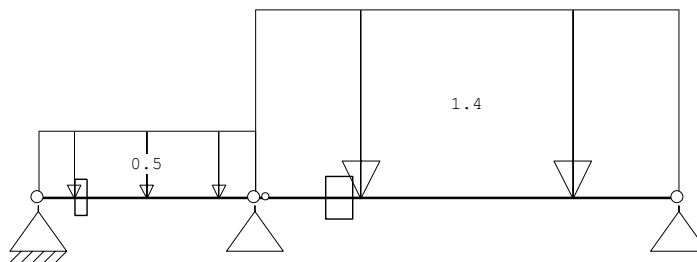

STAAFBELASTINGEN

B.G:1

Permanente belasting

StAAF Type	$q1/p/m$	$q2$	A	B	Ψ_0	Ψ_1	Ψ_2
1 5:QZGloaal	-0.50	-0.50	0.000	0.000			
2 5:QZGloaal	-1.40	-1.40	0.000	0.000			

BELASTINGEN

B.G:2 Ver. bel.

pers. ed. (q_k)

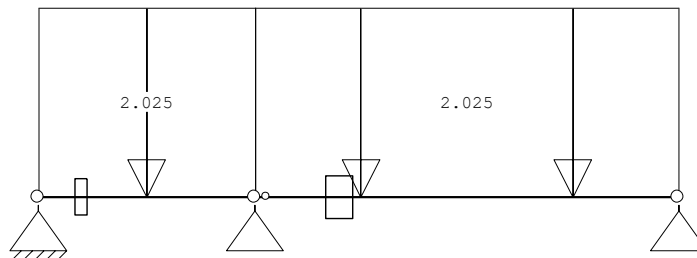

STAAFBELASTINGEN

B.G:2 Ver. bel.

pers. ed. (q_k)

StAAF Type	$q1/p/m$	$q2$	A	B	Ψ_0	Ψ_1	Ψ_2
1 3:QZgeProj.	-2.02	-2.02	0.000	0.000	0.40	0.50	0.30
2 3:QZgeProj.	-2.02	-2.02	0.000	0.000	0.40	0.50	0.30

SITUATIES BELAST/ONBELAST

B.G:2 Ver. bel. pers.

ed. (q_k)

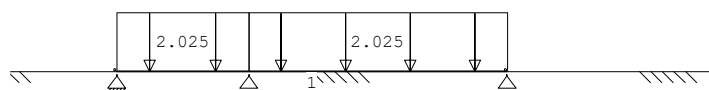

SITUATIES BELAST/ONBELAST

Belastingtype: q_k

Nr Lastvelden belast	Lastvelden onbelast
1	1

Project

55.1, 2, e

Projectnummer

210936

Revisie

D

IRg

Project.....: 210936

Onderdeel.....: Controle bestaande balklaag

BELASTINGEN

B.G:3 Ver. bel.

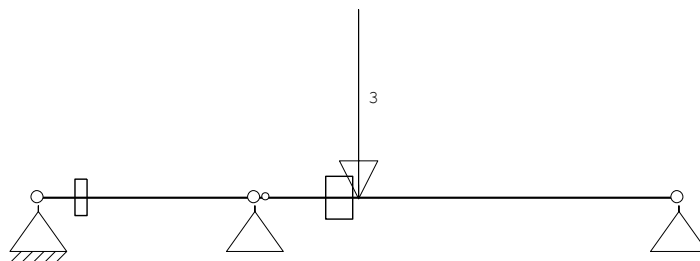
pers. ed. (Q_k)**STAAFBELASTINGEN**

B.G:3 Ver. bel.

pers. ed. (Q_k)

Staaftype	q1/p/m	q2	A	B	ψ ₀	ψ ₁	ψ ₂
2 10:PZGeprojl.	-3.00		1.100		0.40	0.50	0.30

SITUATIES BELAST/ONBELAST

B.G:3 Ver. bel. pers.

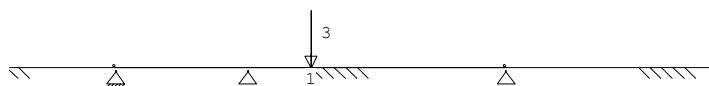
ed. (Q_k)**SITUATIES BELAST/ONBELAST**Belastingtype: Q_k

Nr Lastvelden belast	Lastvelden onbelast
1 1	

BEREKENINGSTATUS

B.C.	Iteratie	Status
1	3	Nauwkeurigheid bereikt
2	3	Nauwkeurigheid bereikt
3	3	Nauwkeurigheid bereikt
4	3	Nauwkeurigheid bereikt
5	3	Nauwkeurigheid bereikt
6	3	Nauwkeurigheid bereikt
7	3	Nauwkeurigheid bereikt
8	3	Nauwkeurigheid bereikt
9	3	Nauwkeurigheid bereikt
10	3	Nauwkeurigheid bereikt
11	1	Lineaire berekening
12	1	Lineaire berekening
13	1	Lineaire berekening
14	1	Lineaire berekening
15	1	Lineaire berekening
16	1	Lineaire berekening
17	1	Lineaire berekening
18	1	Lineaire berekening
19	1	Lineaire berekening

BELASTINGCOMBINATIES

BC	Type	
1	Fund.	1.20 G _{k,1}
2	Fund.	0.90 G _{k,1}
3	Fund.	1.20 G _{k,1} + 1.30 ψ ₀ Q _{k,2}
4	Fund.	1.20 G _{k,1} + 1.30 ψ ₀ Q _{k,3}
5	Fund.	1.15 G _{k,1} + 1.30 Q _{k,2}
6	Fund.	1.15 G _{k,1} + 1.30 Q _{k,3}
7	Fund.	0.90 G _{k,1} + 1.30 Q _{k,2}
8	Fund.	0.90 G _{k,1} + 1.30 ψ ₀ Q _{k,2}
9	Fund.	0.90 G _{k,1} + 1.30 ψ ₀ Q _{k,3}
10	Fund.	0.90 G _{k,1} + 1.30 Q _{k,3}
11	Kar.	1.00 G _{k,1} + 1.00 Q _{k,2}

Project 55.1, 2, e

Projectnummer 210936

Revisie D

IRg

Project.....: 210936
Onderdeel.....: Controle bestaande balklaag

BELASTINGCOMBINATIES

BC Type					
12 Kar.	1.00	$G_{k,1}$	+	1.00	$Q_{k,3}$
13 Quas.	1.00	$G_{k,1}$			
14 Quas.	1.00	$G_{k,1}$	+	1.00	$\Psi_2 Q_{k,2}$
15 Quas.	1.00	$G_{k,1}$	+	1.00	$\Psi_2 Q_{k,3}$
16 Freq.	1.00	$G_{k,1}$			
17 Freq.	1.00	$G_{k,1}$	+	1.00	$\Psi_1 Q_{k,2}$
18 Freq.	1.00	$G_{k,1}$	+	1.00	$\Psi_1 Q_{k,3}$
19 Blij.	1.00	$G_{k,1}$			

GUNSTIGE WERKING PERMANENTE BELASTINGEN

BC Staven met gunstige werking
1 Geen
2 Alle staven de factor:0.90
3 Geen
4 Geen
5 Geen
6 Geen
7 Alle staven de factor:0.90
8 Alle staven de factor:0.90
9 Alle staven de factor:0.90
10 Alle staven de factor:0.90

OMHULLENDE VAN DE FUNDAMENTELE COMBINATIES

MOMENTEN 2e orde
Fundamentele combinatie

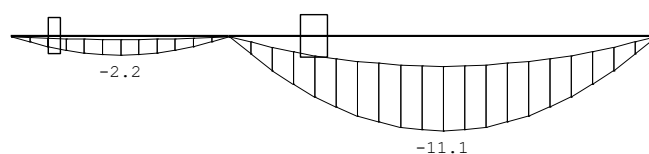

DWARSKRACHTEN 2e orde
Fundamentele combinatie

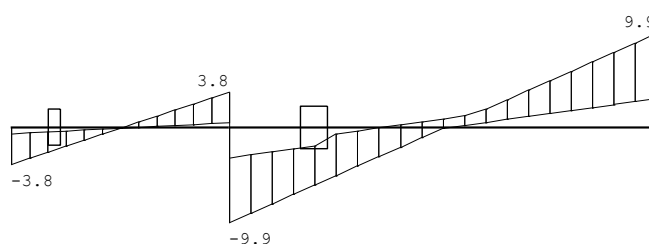

Project

5.1, 2, e

Projectnummer

210936

Revisie

D

IRg

Project.....: 210936

Onderdeel.....: Controle bestaande balklaag

NORMAALKRACHTEN

2e orde

Fundamentele combinatie

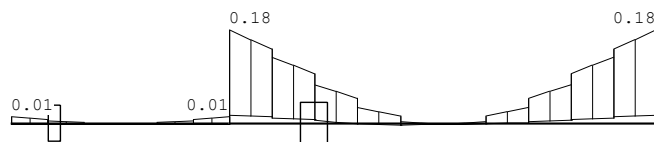
**REACTIES**

2e orde

Fundamentele combinatie

Kn.	X-min	X-max	Z-min	Z-max	M-min	M-max
1	0.00	0.00	0.58	3.77		
2			3.66	13.63		
3			3.08	9.86		

OMHULLENDE VAN DE KARAKTERISTIEKE COMBINATIES**VERPLAATSINGEN**

1e orde [mm]

Karakteristieke combinatie

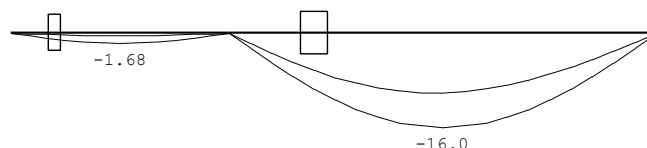
**REACTIES**

1e orde

Karakteristieke combinatie

Kn.	X-min	X-max	Z-min	Z-max	M-min	M-max
1	0.00	0.00	0.64	2.97		
2			6.33	10.95		
3			4.16	7.98		

MATERIAALGEGEVENS

Mt	Kwaliteit	$f_{m,y,k}$ [N/mm ²]	ρ_k [kg/m ³]	ρ_{mean} [kg/m ³]	$f_{t,0,k}$ [N/mm ²]	$f_{t,90,k}$ [N/mm ²]	$f_{c,0,k}$ [N/mm ²]	$f_{c,90,k}$ [N/mm ²]	$f_{v,k}$ [N/mm ²]
1	C18	18	320	380	10.0	0.4	18.0	2.2	3.4
2	C20	20	330	400	11.5	0.4	19.0	2.3	3.6
3	C22	22	340	410	13.0	0.4	20.0	2.4	3.8

MATERIAALGEGEVENS (vervolg)

Mt	Kwaliteit	G_{mean} [N/mm ²]	$E_{0,05}$ [N/mm ²]	$E_{90,mean}$ [N/mm ²]	$E_{0,mean}$ [N/mm ²]	Klimaatklasse	k_{def}	$E_{0,mean,fin}$ [N/mm ²]
1	C18	560	6000	300	9000	I	0.60	5625
2	C20	590	6400	320	9500	I	0.60	5938
3	C22	630	6700	330	10000	I	0.60	6250

KIPSTABILITEIT

Staf	Plts. aanr.	1 sys.	Kipsteunafstanden [m]
1-2	1.0*h	boven: onder:	6.80 0;6.800 6.80 0;6.800

STABILITEIT

Stf	b_{gem} [mm]	h_{gem} [mm]	l_{sys} [mm]	$l_{buc,y/z}$ [mm]	λ_y	λ_z	$\lambda_{rel,y/z}$	β_c	k_y	k_z	$k_{c,y}$	$k_{c,z}$		
1	116	220	2300	nvt	6800	107.1	202.5	1.857	3.512	0.2	2.380	6.989	0.259	0.077
2	116	220	4500	nvt	6800	107.1	202.5	1.857	3.512	0.2	2.380	6.989	0.259	0.077

Project

5.1, 2, e

Projectnummer

210936

Revisie

D

IRg

Project.....: 210936

Onderdeel.....: Controle bestaande balklaag

STABILITEIT (vervolg)

Staf	positie [mm]	$l_{ef,y}$ [mm]	$\sigma_{my,crit}$ [N/mm ²]	$\lambda_{rel,my}$	$k_{crit,y}$
1	1150	7240	42.41	0.69	1.00
2	2250	7240	42.41	0.69	1.00

TOETSING SPANNINGEN

Staf	1	BC / Sit.	5 / 1	UC frm(6.11)	0.35
Staf	2	BC / Sit.	5 / 1	UC frm(6.11)	0.80

TOETSING DOORBUIGING

Stf	Soort	l_{sys} [mm]	Overstek i j	BC Sit	u_{bij} [mm]	Toelaatbaar [mm]	$u_{fin,net}$ [mm]	Toelaatbaar [mm]		
1	Vloer	6800	Nee Nee	14 1	-1.8	-20.4	0.003	-2.1	-27.2	0.004
2	Vloer	6800	Nee Nee	14 1	-14.9	-20.4	0.003	-21.8	-27.2	0.004

TOETSING DOORBUIGING (vervolg)

Stf	Soort	l_{sys} [mm]	Overstek i j	Zeeg [mm]	BC Sit	u_{inst} [mm]	Toelaatbaar [mm]	
1	Vloer	6800	Nee Nee	0.0	11 1	-1.7	-27.2	0.004
2	Vloer	6800	Nee Nee	0.0	11 1	-16.0	-27.2	0.004

VERVORMINGEN Wmax

Karakteristieke combinatie

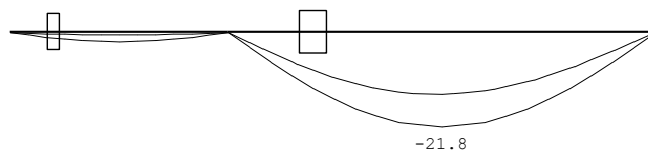
**DOORBUIGINGEN**

Karakteristieke combinatie

Nr.	staven	Zijde	positie [m]	l_{rep} [mm]	w_1 [mm]	w_2 [mm]	w_{bij} [mm]	w_{tot} [mm]	w_c [mm]	w_{max} [mm]	
1	1-2	Neg.	4.550	6800	-6.9	-5.8	-14.9	455	-21.8	-21.8	312

Project

55.1, 2, e

Projectnummer

Revisie

D

IRg

3.6 Dragend hsb wand

p1

	ψ_0	breedte	lengte	kN/m ²	kN/m ¹		kN/m ²	kN/m ¹
3e verdieping	1	0.30	3.40	0.60	<u>0.61</u>	extr.	2.25	<u>2.30</u>
				$G_k =$	0.6		$q_k =$	2.3

Dragend hsb wand uitvoeren met stijlen 50x100 hart op hart 300mm. Bij uiteinden en sparingen dienen dubbele stijlen toegepast te worden tenzij anders aangegeven op tekening.

Project **5.1, 2, e**
 Projectnummer 210936
 Revisie D



Technosoft Construct release 6.70a

15 feb 2022

Project : 210936
 Onderdeel : dragend hsb
 Datum : 04/11/2021
 Eenheden : kN/m/rad
 Bestand : G:\Mijn
 Drive\Projecten\2021\210936\Houtconstructie\
 balklaag.cnw

Toegepaste normen volgens Eurocode met Nederlandse NB

Belastingen	NEN-EN 1990:2002	C2:2010	NB:2011 (nl)
	NEN-EN 1991-1-1:2002	C1:2009	NB:2011 (nl)
Hout	NEN-EN 1995-1-1:2005	A1:2011, C1:2006	NB:2013 (nl)
	NEN-EN 14080:2013		

dragend hsb

Algemene gegevens

B x H	[mm] : 50 x 100	Referentie periode [j]:	50
l_{sys}	[mm] : 3000		
$l_{buc,y}$	[mm] : 3000	Toelaatbare doorbuiging	
$l_{buc,z}$	[mm] : 3000	Bijkomend [* l] :	0.003
Plaats kipsteun	: Bovenkant		
Steunpunt links	: Rol	Eind [* l] :	0.004
Steunpunt rechts	: Scharnier		
Sterkteklasse	: C24	Klimaatklasse :	I

Belastingen **Permanent** **Veranderlijk**

Q_z	[kN/m] :	0.00	0.00
Ψ_0	[-] :		0.40
Ψ_2	[-] :		0.30
F_z	[kN] :	0.00	0.00
Vanaf links	[mm] :	0	
N_x	[kN] :	0.30	2.30
$M_{y,links}$	[kNm] :	0.00	0.00
$M_{y,rechts}$	[kNm] :	0.00	0.00

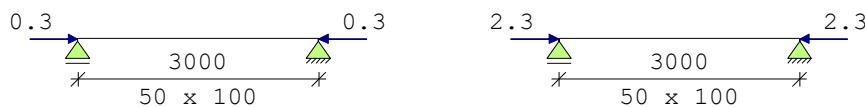

Belastingfactoren (NEN-EN 1990)

Formule 6.10a: γ_G : 1.35 γ_Q : 1.50
 Formule 6.10b: $\xi\gamma_G$: 1.20 γ_Q : 1.50

Partiële factor (Tabel 2.3 NEN-EN 1995-1-1)
 γ_M [-]: 1.30

Project

5.1.2.e
5.1, 2, e

Projectnummer

210936

Revisie

D



Stabiliteit

1. Factoren t.b.v. toetsing knikstabiliteit volgens par. 6.3.2.:

k_y	[-]	: 2.20	frm(6.27)	$k_{c,y}$	[-]	: 0.28
frm(6.25)						
k_z	[-]	: 7.03	frm(6.28)	$k_{c,z}$	[-]	: 0.08
frm(6.26)						

2. Toetsing kipstabiliteit volgens par. 6.3.3. is n.v.t.:

- geen buigend moment op de staaf.

Fundamentele combinatie (6.10a)

frm(6.24)

u.c. 0.36

Normaalkracht [kN]	1.8	$\sigma_{c,0,d}$	[N/mm ²]	0.36		
Dwarskracht [kN]	0.0	$\tau_{v,d}$	[N/mm ²]	0.00		
Moment [kNm]	0.0	$\sigma_{m,y,d}$	[N/mm ²]	0.00		
$f_{m,y,d}$ [N/mm ²]	16.0	$f_{c,0,d}$	[N/mm ²]	12.92	b_{ef}	50 [mm]
frm(6.13a)						
$f_{t,0,d}$ [N/mm ²]	9.7	$f_{v,d}$	[N/mm ²]	2.46	k_{mod}	0.80 [-]
tab(3.1)						

Fundamentele combinatie (6.10b)

frm(6.24)

u.c. 0.77

Normaalkracht [kN]	3.8	$\sigma_{c,0,d}$	[N/mm ²]	0.76		
Dwarskracht [kN]	0.0	$\tau_{v,d}$	[N/mm ²]	0.00		
Moment [kNm]	0.0	$\sigma_{m,y,d}$	[N/mm ²]	0.00		
$f_{m,y,d}$ [N/mm ²]	16.0	$f_{c,0,d}$	[N/mm ²]	12.92	b_{ef}	50 [mm]
frm(6.13a)						
$f_{t,0,d}$ [N/mm ²]	9.7	$f_{v,d}$	[N/mm ²]	2.46	k_{mod}	0.80 [-]
tab(3.1)						

Doorbuiging

u.c.

u_{bij}	=	0.00	<	9.00 [mm]	0.00
$u_{net,fin}$	=	0.00	<	12.00 [mm]	0.00

Project

5.5.1, 2, e

Projectnummer

210936

Revisie

D

The logo for IRg, consisting of the letters 'IRg' in a white, sans-serif font on a dark green rectangular background.

3.7 Controle spant

Op de 4^e verdieping meer hoogte te geven wordt de hanebalk verhoogt. Er is niet bekend wat de afmetingen zijn van de spanten er wordt aangenomen dat deze 70*200mm zijn. De hanebalk wordt ongeveer 400mm verhoogt. Het spant is niet draagkrachtig genoeg en dient verstijft te worden met 2x50*200mm.

Project 55.1, 2, e

Projectnummer 210936

Revisie D



Technosoft Raamwerken release 6.73b

15 feb 2022

Project.....: 210936
Onderdeel.....: Controle spant
Constructeur.: Kaj
Dimensies.....: kN;m;rad (tenzij anders aangegeven)
Datum.....: 15/02/2022
Bestand.....: G:\Mijn
Drive\Projecten\2021\210936\Houtconstructie\210936 -
controle spant.rww

Belastingbreedte.: 3.910
Rekenmodel.....: 2e-orde-elastisch.
Theorieën voor de bepaling van de krachtsverdeling:
1) Uiterste grenstoestand:
Geometrisch niet lineair alle staven.
Fysisch lineair alle staven.
2) Gebruiksgrenstoestand:
Lineaire-elasticiteitstheorie

Maximum aantal iteraties.....: 50
Max.deellengte kolommen/wanden: 0.500 Max.deellengte balken/vloeren: 0.500
Max. X-verplaatsing in UGT.....: 0.500 Max. Z-verplaatsing in UGT...: 0.250

Gunstige werking van de permanente belasting wordt automatisch verwerkt.

Belastingfactoren zijn bepaald conform NEN8700:2011
Tabel A1.2(B) en (C): Factoren bij verbouw.
Factoren ten behoeve van Bouwbesluit 2003 of daarvoor.

Toegepaste normen volgens Eurocode met Nederlandse NB

Belastingen	NEN-EN 1990:2002	C2:2010,A1:2019	NB:2019 (nl)
	NEN-EN 1991-1-1:2002	C1/C11:2019	NB:2019 (nl)
	NEN 8700:2011		
	NEN-EN 1991-1-4:2005	C2:2011	NB:2011 (nl)
Hout	NEN-EN 1995-1-1:2005	A1:2011,C1:2006	NB:2013 (nl)

GEOMETRIE

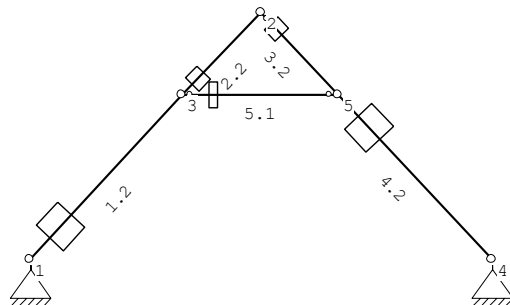

MATERIALEN

Mt	Kwaliteit	E-modulus[N/mm ²]	S.G.	S.G.verhoogd	Pois.	Uitz. coëff
1	C18	9000	3.2	3.8	1.00	5.0000e-06
2	C20	9500	3.3	4.0	1.00	5.0000e-06
3	C22	10000	3.4	4.1	1.00	5.0000e-06

Bij de bepaling v.h. e.g. van houten staven is de S.G.verhoogd toegepast.

PROFIELEN [mm]

Prof.	Omschrijving	Materiaal	Oppervlak	Traagheid	Vormf.
1	B*H 70*200	1:C18	1.4000e+04	4.6667e+07	0.00
2	B*H 170*200	2:C20	3.4000e+04	1.1333e+08	0.00

Project

5.1.2 e
5.1, 2, e

Projectnummer

210936

Revisie

D



Project.....: 210936

Onderdeel.....: Controle spant

PROFIELEN vervolg [mm]

Prof.	Staaftype	Breedte	Hoogte	e	Type	b1	h1	b2	h2
1	0:Normaal	70	200	100.0	0:RH				
2	0:Normaal	170	200	100.0	0:RH				

PROFIELVORMEN [mm]

1 B*H 70*200



2 B*H 170*200



KNOPEN

Knoop	X	Z
1	0.000	13.550
2	3.400	17.150
3	2.237	15.950
4	6.800	13.550
5	4.533	15.950

STAVEN

St.	ki	kj	Profiel	Aansl.i	Aansl.j	Lengte	Opm.
1	1	3	2:B*H 170*200	NDM	NDM	3.281	
2	3	2	2:B*H 170*200	NDM	NDM	1.671	
3	2	5	2:B*H 170*200	ND-	NDM	1.651	
4	5	4	2:B*H 170*200	NDM	NDM	3.301	
5	3	5	1:B*H 70*200	ND-	ND-	2.296	

VASTE STEUNPUNTEN

Nr. knoop	Kode	XZR	l=vast	0=vrij	Hoek
1	1	110			0.00
2	4	110			0.00

BELASTINGGENERATIE ALGEMEEN.

Betrouwbaarheidsklasse.....:	2	Referentieperiode.....:	50
Gebouwdiepte.....:	14.65	Gebouwhoogte.....:	17.15
Niveau aansl.terrein.....:	0.00	E.g. scheid.w. [kN/m2]:	1.20

WIND

Terrein categorie ...[4.3.2]....:	Bebouwd
Windgebied	2 Vb,0 ..[4.2].....: 27.000
Positie spant in het gebouw....:	1.000 Kr ...[4.3.2].....: 0.223
z0	[4.3.2]....: 0.500 zmin ..[4.3.2].....: 7.000
Co wind van links ..[4.3.3]....:	1.000 Co wind van rechts....: 1.000
Co wind loodrecht ..[4.3.3]....:	1.000
Cpi wind van links ..[7.2.9]....:	0.200 -0.300
Cpi windloodrecht ...[7.2.9]....:	0.200 -0.300
Cpi wind van rechts ..[7.2.9]....:	0.200 -0.300
Cfr windwrijving[7.5].....:	0.040

STAAFTYPEN

Type	staven
1:Vloer.	: 5
7:Dak.	: 1-4

Project

5.1, 2, e
5.1, 2, e

Projectnummer

36

Revisie

D

IRg

Project.....: 210936

Onderdeel.....: Controle spant

LASTVELDEN

Wind staven

Sneeuw staven

**WIND DAKTYPES**

Nr.	Staaft Type	reductie bij wind van links	reductie bij wind van rechts	Cpe volgens art:
1	1-2 Zadel dak	1.000	1.000	7.2.5
2	3-4 Zadel dak	1.000	1.000	7.2.5

WIND ZONES

Wind van links

Wind van rechts

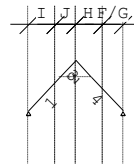
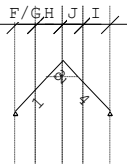
**WIND VAN LINKS ZONES****WIND VAN RECHTS ZONES**

Nr.	Staaft	Positie	Lengte	Zone	Nr.	Staaft	Positie	Lengte	Zone
1	1-2	0.000	1.465	F/G	1	3-4	0.000	1.465	F/G
2	1-2	1.465	1.935	H	2	3-4	1.465	1.935	H
3	3-4	0.000	1.465	J	3	1-2	0.000	1.465	J
4	3-4	1.465	1.935	I	4	1-2	1.465	1.935	I

Wind indexen

Index	CsCd	Cpe/Cpi	qp	breedte	reductie	Qw	Zone	Hoek(en)
Qw1		0.300	0.844	3.910		-0.990	-i	
Qw2	1.00	0.700	0.844	3.662		-2.163	F	46.6 47.0
Qw3	1.00	0.700	0.844	0.248		-0.146	G	46.6 47.0
Qw4	1.00	0.613	0.844	3.910		-2.022	H	47.0
Qw5	1.00	0.605	0.844	3.910		-1.997	H	45.9
Qw6	1.00	-0.300	0.844	3.910		0.990	J	45.9 47.0
Qw7	1.00	-0.200	0.844	3.910		0.660	I	46.6 47.0
Qw8		-0.200	0.844	3.910		0.660	+i	
Qw9	1.00	0.610	0.844	3.910		-2.013	H	46.6

Project

5.1, 2, e

Projectnummer

210936

Revisie

D

IRg

Project.....: 210936

Onderdeel.....: Controle spant

BELASTINGGEVALLEN

B.G.	Omschrijving	EGZ=-1.00	Type
	1	Permanente belasting	1
g	2	Wind van links onderdruk A	7
g	3	Wind van links overdruk A	8
g	4	Wind van rechts onderdruk A	11
g	5	Wind van rechts overdruk A	12

g = gegeneerd belastinggeval

BELASTINGGEVALLEN vervolg

B.G.	Omschrijving	Belastingduurklasse
	1	Permanente belasting
	2	Wind van links onderdruk A
	3	Wind van links overdruk A
	4	Wind van rechts onderdruk A
	5	Wind van rechts overdruk A

BELASTINGEN

B.G:1

Permanente belasting

Eigen gewicht van alle staven is meegenomen in berekening. Richting:↓

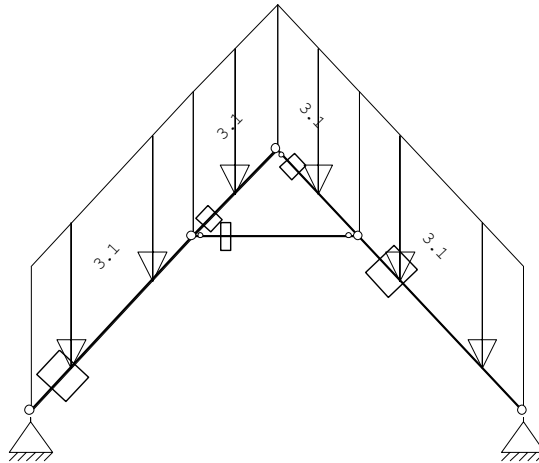
**STAAFBELASTINGEN**

B.G:1

Permanente belasting

StAAF	Type	q1/p/m	q2	A	B	ψ_0	ψ_1	ψ_2
1	5:QZGlobaal	-3.10	-3.10	0.000	0.000			
2	5:QZGlobaal	-3.10	-3.10	0.000	0.000			
3	5:QZGlobaal	-3.10	-3.10	0.000	0.000			
4	5:QZGlobaal	-3.10	-3.10	0.000	0.000			

Project

5.1, 2, a
5.1, 2, e



Projectnummer

210936

Revisie

D

Project.....: 210936

Onderdeel.....: Controle spant

BELASTINGEN

links onderdruk A

B.G:2 Wind van

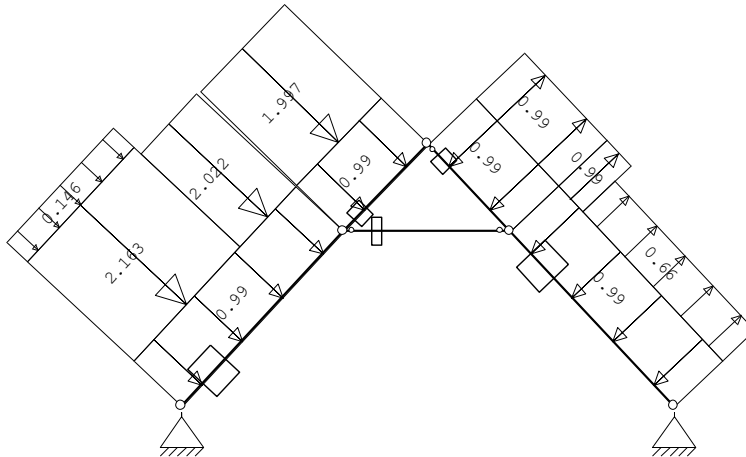

STAAFBELASTINGEN

onderdruk A

B.G:2 Wind van links

Staaftype	Index	q1/p/m	q2	A	B	Ψ_0	Ψ_1	Ψ_2
1 1:QZLokaal	Qw1	-0.99	-0.99	0.000	0.000	0.00	0.20	0.00
2 1:QZLokaal	Qw1	-0.99	-0.99	0.000	0.000	0.00	0.20	0.00
3 1:QZLokaal	Qw1	-0.99	-0.99	0.000	0.000	0.00	0.20	0.00
4 1:QZLokaal	Qw1	-0.99	-0.99	0.000	0.000	0.00	0.20	0.00
1 1:QZLokaal	Qw2	-2.16	-2.16	0.000	1.132	0.00	0.20	0.00
1 1:QZLokaal	Qw3	-0.15	-0.15	0.000	1.132	0.00	0.20	0.00
1 1:QZLokaal	Qw4	-2.02	-2.02	2.149	0.000	0.00	0.20	0.00
2 1:QZLokaal	Qw5	-2.00	-2.00	0.000	0.000	0.00	0.20	0.00
3 1:QZLokaal	Qw6	0.99	0.99	0.000	0.000	0.00	0.20	0.00
4 1:QZLokaal	Qw6	0.99	0.99	0.000	2.818	0.00	0.20	0.00
4 1:QZLokaal	Qw7	0.66	0.66	0.483	0.000	0.00	0.20	0.00

BELASTINGEN

links overdruk A

B.G:3 Wind van

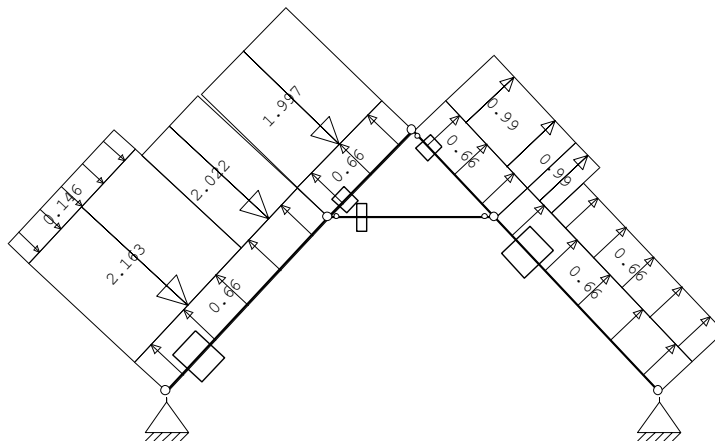

Project

5.1, 2, e

Projectnummer

210936

Revisie

D

IRg

Project.....: 210936

Onderdeel.....: Controle spant

STAAFBELASTINGEN

B.G:3 Wind van links

overdruk A

Staaftype	Type	Index	q1/p/m	q2	A	B	Ψ_0	Ψ_1	Ψ_2
1	1:QZLokaal	Qw8	0.66	0.66	0.000	0.000	0.00	0.20	0.00
2	1:QZLokaal	Qw8	0.66	0.66	0.000	0.000	0.00	0.20	0.00
3	1:QZLokaal	Qw8	0.66	0.66	0.000	0.000	0.00	0.20	0.00
4	1:QZLokaal	Qw8	0.66	0.66	0.000	0.000	0.00	0.20	0.00
1	1:QZLokaal	Qw2	-2.16	-2.16	0.000	1.132	0.00	0.20	0.00
1	1:QZLokaal	Qw3	-0.15	-0.15	0.000	1.132	0.00	0.20	0.00
1	1:QZLokaal	Qw4	-2.02	-2.02	2.149	0.000	0.00	0.20	0.00
2	1:QZLokaal	Qw5	-2.00	-2.00	0.000	0.000	0.00	0.20	0.00
3	1:QZLokaal	Qw6	0.99	0.99	0.000	0.000	0.00	0.20	0.00
4	1:QZLokaal	Qw6	0.99	0.99	0.000	2.818	0.00	0.20	0.00
4	1:QZLokaal	Qw7	0.66	0.66	0.483	0.000	0.00	0.20	0.00

BELASTINGEN

B.G:4 Wind van

rechts overdruk A

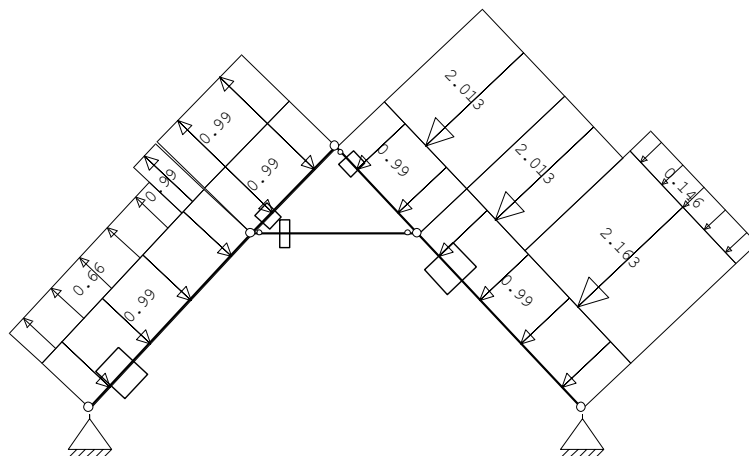
**STAAFBELASTINGEN**

B.G:4 Wind van rechts

onderdruk A

Staaftype	Type	Index	q1/p/m	q2	A	B	Ψ_0	Ψ_1	Ψ_2
1	1:QZLokaal	Qw1	-0.99	-0.99	0.000	0.000	0.00	0.20	0.00
2	1:QZLokaal	Qw1	-0.99	-0.99	0.000	0.000	0.00	0.20	0.00
3	1:QZLokaal	Qw1	-0.99	-0.99	0.000	0.000	0.00	0.20	0.00
4	1:QZLokaal	Qw1	-0.99	-0.99	0.000	0.000	0.00	0.20	0.00
4	1:QZLokaal	Qw2	-2.16	-2.16	1.168	0.000	0.00	0.20	0.00
4	1:QZLokaal	Qw3	-0.15	-0.15	1.168	0.000	0.00	0.20	0.00
4	1:QZLokaal	Qw9	-2.01	-2.01	0.000	2.134	0.00	0.20	0.00
3	1:QZLokaal	Qw9	-2.01	-2.01	0.000	0.000	0.00	0.20	0.00
2	1:QZLokaal	Qw6	0.99	0.99	0.000	0.000	0.00	0.20	0.00
1	1:QZLokaal	Qw6	0.99	0.99	2.838	0.000	0.00	0.20	0.00
1	1:QZLokaal	Qw7	0.66	0.66	0.000	0.443	0.00	0.20	0.00

Project

5.1, 2, e

Projectnummer

210936

Revisie

D

IRg

Project.....: 210936

Onderdeel.....: Controle spant

BELASTINGEN

rechts overdruk A

B.G:5 Wind van

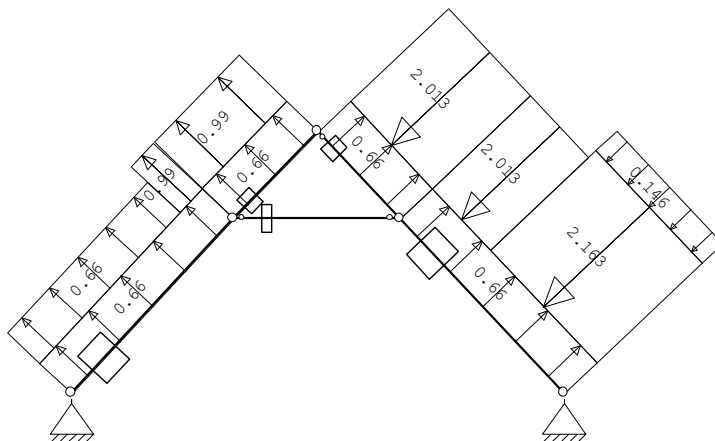
**STAAFBELASTINGEN**

overdruk A

B.G:5 Wind van rechts

Staaftype	Index	q1/p/m	q2	A	B	ψ_0	ψ_1	ψ_2
1:QZLokaal	Qw8	0.66	0.66	0.000	0.000	0.00	0.20	0.00
2:QZLokaal	Qw8	0.66	0.66	0.000	0.000	0.00	0.20	0.00
3:QZLokaal	Qw8	0.66	0.66	0.000	0.000	0.00	0.20	0.00
4:QZLokaal	Qw8	0.66	0.66	0.000	0.000	0.00	0.20	0.00
4:QZLokaal	Qw2	-2.16	-2.16	1.168	0.000	0.00	0.20	0.00
4:QZLokaal	Qw3	-0.15	-0.15	1.168	0.000	0.00	0.20	0.00
4:QZLokaal	Qw9	-2.01	-2.01	0.000	2.134	0.00	0.20	0.00
3:QZLokaal	Qw9	-2.01	-2.01	0.000	0.000	0.00	0.20	0.00
2:QZLokaal	Qw6	0.99	0.99	0.000	0.000	0.00	0.20	0.00
1:QZLokaal	Qw6	0.99	0.99	2.838	0.000	0.00	0.20	0.00
1:QZLokaal	Qw7	0.66	0.66	0.000	0.443	0.00	0.20	0.00

BEREKENINGSTATUS

B.C.	Iteratie	Status
1	3	Nauwkeurigheid bereikt
2	3	Nauwkeurigheid bereikt
3	3	Nauwkeurigheid bereikt
4	3	Nauwkeurigheid bereikt
5	3	Nauwkeurigheid bereikt
6	3	Nauwkeurigheid bereikt
7	3	Nauwkeurigheid bereikt
8	3	Nauwkeurigheid bereikt
9	3	Nauwkeurigheid bereikt
10	3	Nauwkeurigheid bereikt
11	3	Nauwkeurigheid bereikt
12	3	Nauwkeurigheid bereikt
13	3	Nauwkeurigheid bereikt
14	3	Nauwkeurigheid bereikt
15	3	Nauwkeurigheid bereikt
16	3	Nauwkeurigheid bereikt
17	3	Nauwkeurigheid bereikt
18	3	Nauwkeurigheid bereikt
19	1	Lineaire berekening
20	1	Lineaire berekening
21	1	Lineaire berekening
22	1	Lineaire berekening
23	1	Lineaire berekening
24	1	Lineaire berekening
25	1	Lineaire berekening
26	1	Lineaire berekening
27	1	Lineaire berekening

Project

5.1.2.e
5.1, 2, e

Projectnummer

210936

Revisie

D

IRg

Project.....: 210936

Onderdeel.....: Controle spant

BEREKENINGSTATUS

B.C. Iteratie Status

28	1	Lineaire berekening
29	1	Lineaire berekening

BELASTINGCOMBINATIES

BC Type

1 Fund.	1.20	$G_{k,1}$		
2 Fund.	0.90	$G_{k,1}$		
3 Fund.	1.15	$G_{k,1}$	+ 1.40	$Q_{k,2}$
4 Fund.	1.15	$G_{k,1}$	+ 1.40	$Q_{k,3}$
5 Fund.	1.15	$G_{k,1}$	+ 1.40	$Q_{k,4}$
6 Fund.	1.15	$G_{k,1}$	+ 1.40	$Q_{k,5}$
7 Fund.	1.10	$G_{k,1}$	+ 1.50	$Q_{k,2}$
8 Fund.	1.10	$G_{k,1}$	+ 1.50	$Q_{k,3}$
9 Fund.	1.10	$G_{k,1}$	+ 1.50	$Q_{k,4}$
10 Fund.	1.10	$G_{k,1}$	+ 1.50	$Q_{k,5}$
11 Fund.	0.90	$G_{k,1}$	+ 1.50	$Q_{k,2}$
12 Fund.	0.90	$G_{k,1}$	+ 1.40	$Q_{k,2}$
13 Fund.	0.90	$G_{k,1}$	+ 1.50	$Q_{k,3}$
14 Fund.	0.90	$G_{k,1}$	+ 1.40	$Q_{k,3}$
15 Fund.	0.90	$G_{k,1}$	+ 1.50	$Q_{k,4}$
16 Fund.	0.90	$G_{k,1}$	+ 1.40	$Q_{k,4}$
17 Fund.	0.90	$G_{k,1}$	+ 1.50	$Q_{k,5}$
18 Fund.	0.90	$G_{k,1}$	+ 1.40	$Q_{k,5}$
19 Kar.	1.00	$G_{k,1}$	+ 1.00	$Q_{k,2}$
20 Kar.	1.00	$G_{k,1}$	+ 1.00	$Q_{k,3}$
21 Kar.	1.00	$G_{k,1}$	+ 1.00	$Q_{k,4}$
22 Kar.	1.00	$G_{k,1}$	+ 1.00	$Q_{k,5}$
23 Quas.	1.00	$G_{k,1}$		
24 Freq.	1.00	$G_{k,1}$		
25 Freq.	1.00	$G_{k,1}$	+ 1.00	$\Psi_1 Q_{k,2}$
26 Freq.	1.00	$G_{k,1}$	+ 1.00	$\Psi_1 Q_{k,3}$
27 Freq.	1.00	$G_{k,1}$	+ 1.00	$\Psi_1 Q_{k,4}$
28 Freq.	1.00	$G_{k,1}$	+ 1.00	$\Psi_1 Q_{k,5}$
29 Blij.	1.00	$G_{k,1}$		

GUNSTIGE WERKING PERMANENTE BELASTINGEN

BC Staven met gunstige werking

1	Geen
2	Alle staven de factor:0.90
3	Geen
4	Geen
5	Geen
6	Geen
7	Geen
8	Geen
9	Geen
10	Geen
11	Alle staven de factor:0.90
12	Alle staven de factor:0.90
13	Alle staven de factor:0.90
14	Alle staven de factor:0.90
15	Alle staven de factor:0.90
16	Alle staven de factor:0.90
17	Alle staven de factor:0.90
18	Alle staven de factor:0.90

Project

5.1.2.e

Projectnummer

210936

Revisie

D



Project.....: 210936

Onderdeel.....: Controle spant

OMHULLENDE VAN DE FUNDAMENTELE COMBINATIES

MOMENTEN 2e orde
Fundamentele combinatie

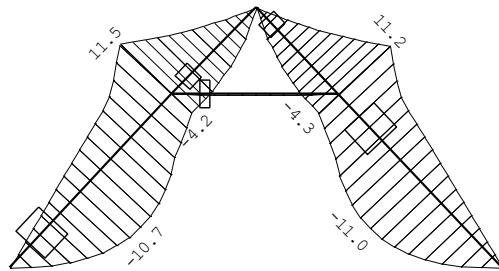

DWARSKRACHTEN 2e orde
Fundamentele combinatie

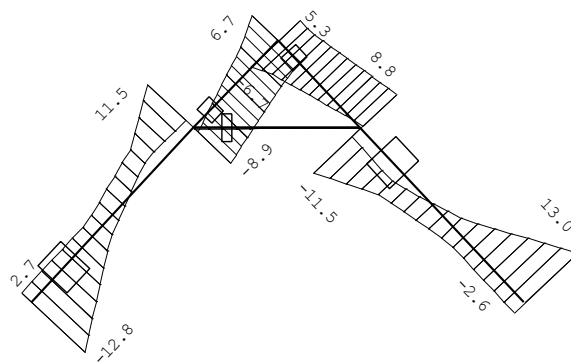

Project

5.1, 2, e

Projectnummer

210936

Revisie

D

IRg

Project.....: 210936

Onderdeel.....: Controle spant

NORMAALKRACHTEN

2e orde

Fundamentele combinatie

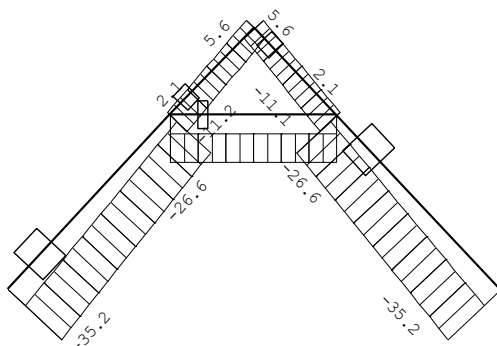
**REACTIES**

2e orde

Fundamentele combinatie

Kn.	X-min	X-max	Z-min	Z-max	M-min	M-max
1	1.52	22.89	14.02	26.90		
4	-22.94	-1.48	14.00	26.84		

OMHULLENDE VAN DE KARAKTERISTIEKE COMBINATIES**VERPLAATSINGEN**

1e orde [mm]

Karakteristieke combinatie

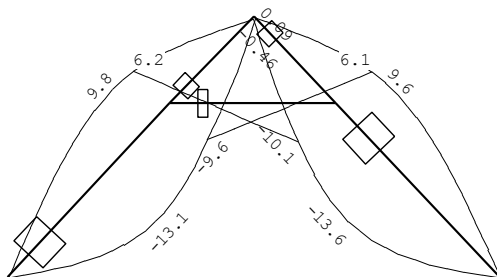
**REACTIES**

1e orde

Karakteristieke combinatie

Kn.	X-min	X-max	Z-min	Z-max	M-min	M-max
1	5.44	18.21	15.81	22.05		
4	-18.24	-5.42	15.78	22.01		

MATERIAALGEGEVENS

Mt	Kwaliteit	$f_{m,y,k}$ [N/mm ²]	ρ_k [kg/m ³]	ρ_{mean} [kg/m ³]	$f_{t,0,k}$ [N/mm ²]	$f_{t,90,k}$ [N/mm ²]	$f_{c,0,k}$ [N/mm ²]	$f_{c,90,k}$ [N/mm ²]	$f_{v,k}$ [N/mm ²]
1	C18	18	320	380	10.0	0.4	18.0	2.2	3.4
2	C20	20	330	400	11.5	0.4	19.0	2.3	3.6
3	C22	22	340	410	13.0	0.4	20.0	2.4	3.8

MATERIAALGEGEVENS (vervolg)

Mt	Kwaliteit	G_{mean} [N/mm ²]	$E_{0,05}$ [N/mm ²]	$E_{0,mean}$ [N/mm ²]	$E_{0,mean}$ [N/mm ²]	Klimaatklasse	k_{def}	$E_{0,mean,fin}$ [N/mm ²]
1	C18	560	6000	300	9000	I	0.60	5625

Project

5.1.2.e
5.1, 2, e

Projectnummer

210936

Revisie

D

IRg

Project.....: 210936

Onderdeel.....: Controle spant

MATERIAALGEGEVENS (vervolg)

Mt	Kwaliteit	G_{mean} [N/mm ²]	$E_{0,05}$ [N/mm ²]	$E_{0,0mean}$ [N/mm ²]	$E_{0,mean}$ [N/mm ²]	Klimaatklasse	k_{def}	$E_{0,mean,fin}$ [N/mm ²]
2	C20	590	6400	320	9500	I	0.60	5938
3	C22	630	6700	330	10000	I	0.60	6250

KIPSTABILITEIT

Staafl	Plts. aangr.	l sys. [m]	Kipsteunafstanden [m]
1-2	1.0*h	boven:	4.95 0;3,281;1,671
		onder:	4.95 0;3,281;1,671
3-4	1.0*h	boven:	4.95 0;1,6506;3,3012
		onder:	4.95 0;1,6506;3,3012
5	1.0*h	boven:	2.30 0;2.296
		onder:	2.30 0;2.296

STABILITEIT

Stf	b_{gem} [mm]	h_{gem} [mm]	l_{sys} [mm]	$l_{buc,y/z}$ [mm]	λ_y	λ_z	$\lambda_{rel,y/z}$	β_c	k_y	k_z	$k_{c,y}$	$k_{c,z}$		
1	170	200	3281	nvt	4952	85.8	100.9	1.488	1.750	0.2	1.725	2.176	0.385	0.288
2	170	200	1671	nvt	4952	85.8	100.9	1.488	1.750	0.2	1.725	2.176	0.385	0.288
3	170	200	1651	nvt	4952	85.8	100.9	1.488	1.750	0.2	1.725	2.176	0.385	0.288
4	170	200	3301	nvt	4952	85.8	100.9	1.488	1.750	0.2	1.725	2.176	0.385	0.288
5	70	200	2296	nvt	2296	39.8	113.6	0.693	1.981	0.2	0.780	2.631	0.880	0.229

STABILITEIT (vervolg)

Staafl	positie [mm]	$l_{ef,y}$ [mm]	$\sigma_{y,crit}$ [N/mm ²]	$\lambda_{rel,my}$	$k_{crit,y}$
1	3280	3181	226.77	0.30	1.00
2	0	1404	513.81	0.20	1.00
3	1650	1386	520.49	0.20	1.00
4	0	3201	225.35	0.30	1.00
5	1148	2466	46.49	0.62	1.00

TOETSING SPANNINGEN

Staafl						
Staafl	1	BC / Sit.	9 / 1	UC frm(6.23)	0.89	
Staafl	2	BC / Sit.	9 / 1	UC frm(6.23)	0.80	
Staafl	3	BC / Sit.	7 / 1	UC frm(6.23)	0.78	
Staafl	4	BC / Sit.	7 / 1	UC frm(6.23)	0.87	
Staafl	5	BC / Sit.	7 / 1	UC frm(6.24)	0.57	

TOETSING DOORBUIGING

Stf	Soort	l_{sys} [mm]	Overstek i j	BC Sit	u_{bij} [mm]	Toelaatbaar *1	$u_{fin,net}$ [mm]	Toelaatbaar *1		
1	Dak	4952	Nee Nee	23 1	-11.9	-19.8	0.004	-13.6	-19.8	0.004
2	Dak	1671	Nee Nee	23 1	0.1	13.4	2*0.004	0.1	13.4	2*0.004
3	Dak	4952	Nee Nee	23 1	-9.7	-19.8	0.004	-10.0	-19.8	0.004
4	Dak	4952	Nee Nee	23 1	-12.6	-19.8	0.004	-14.6	-19.8	0.004
5	Vloer	2296	Nee Nee	23 1	-13.1	-13.8	2*0.003	-13.3	-18.4	2*0.004

TOETSING DOORBUIGING (vervolg)

Stf	Soort	l_{sys} [mm]	Overstek i j	Zeeg BC Sit	u_{inst} [mm]	Toelaatbaar *1	
1	Dak	4952	Nee Nee	0.0 19 1	-13.0	-19.8	0.004
2	Dak	4952	Nee Nee	0.0 19 1	-9.4	-19.8	0.004
3	Dak	4952	Nee Nee	0.0 21 1	-9.8	-19.8	0.004
4	Dak	4952	Nee Nee	0.0 21 1	-13.5	-19.8	0.004
5	Vloer	2296	Nee Nee	0.0 21 1	-13.2	-18.4	2*0.004

Project

55.1, 2, e

Projectnummer

210936

Revisie

D

IRg

Project.....: 210936

Onderdeel.....: Controle spant

VERVORMINGEN W_{max}

Karakteristieke combinatie

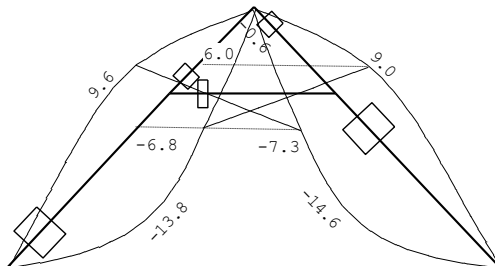
**DOORBUIGINGEN**

Karakteristieke combinatie

Nr.	staven	Zijde	positie	l_{rep} [m]	W_1 [mm]	W_2 [mm]	W_{bij} [mm]	l_{rep}	W_{tot} [mm]	W_c [mm]	W_{max} [mm]	l_{rep}
1	1-2	Neg.	2.149	4952	-1.3	-0.8	-12.4	398	-13.8	-13.8	360	
1	1-2	Pos.	2.838	4952	-0.5	-0.3	10.1	491	9.6	9.6	516	
2	3-4	Neg.	2.818	4952	-1.8	-1.1	-12.8	386	-14.6	-14.6	339	
2	3-4	Pos.	2.134	4952	-0.9	-0.5	9.9	502	9.0	9.0	553	
3	5	Neg.	/	4592	-0.2	-0.1	-13.1	351	-13.3	-13.3	345	
3	5	Pos.	/	4592	-0.2	-0.1	12.6	364	12.4	12.4	370	

TOTALE HORIZONTALE VERPLAATSING

Karakteristieke

combinatie

knoop	Zijde	h	u_1	u_2	u_3	u_{tot}	h
		[mm]	[mm]	[mm]	[mm]	[mm]	[h/]
5	Neg.	2400	-0.2	-0.1	-7.0	-7.4	326
3	Pos.	2400		-0.0	6.9	6.9	348

Project

55.1, 2, e

Projectnummer

210936

Revisie

D

IRg

3.8 Houten latei

q1

	ψ_0	breedte	lengte	kN/m ²	kN/m ¹		kN/m ²	kN/m ¹
4e verdieping	1	0.60	6.80	0.60	2.45	extr.	2.25	9.18
3e verdieping	1	0.60	6.80	0.60	2.45	extr.	2.25	9.18
hsb wand		1.00	3.50	0.50	1.75			
				$g_k =$	6.6		$q_k =$	18.4

Project

5.5.1, 2, e

Projectnummer

210936

Revisie

D



Technosoft Raamwerken release 6.73b

18 feb 2022

Project.....: 210936
Onderdeel....: Houten latei
Constructeur.: Kaj
Dimensies....: kN;m;rad (tenzij anders aangegeven)
Datum.....: 18/02/2022
Bestand.....: G:\Mijn
Drive\Projecten\2021\210936\Houtconstructie\210936 -
houten latei.rww

Belastingbreedte.: 8.160
Rekenmodel.....: 2e-orde-elastisch.
Theorieën voor de bepaling van de krachtsverdeling:
1) Uiterste grenstoestand:
Geometrisch niet lineair alle staven.
Fysisch lineair alle staven.
2) Gebruiksgrenstoestand:
Lineaire-elasticiteitstheorie

Maximum aantal iteraties.....: 50
Max.deellengte kolommen/wanden: 0.500 Max.deellengte balken/vloeren: 0.500
Max. X-verplaatsing in UGT.....: 0.500 Max. Z-verplaatsing in UGT...: 0.250

Gunstige werking van de permanente belasting wordt automatisch verwerkt.

Belastingfactoren zijn bepaald conform NEN8700:2011
Tabel A1.2(B) en (C): Factoren bij verbouw.

Toegepaste normen volgens Eurocode met Nederlandse NB

Belastingen	NEN-EN 1990:2002	C2:2010,A1:2019	NB:2019 (nl)
	NEN-EN 1991-1-1:2002	C1/C11:2019	NB:2019 (nl)
	NEN 8700:2011		
Hout	NEN-EN 1995-1-1:2005	A1:2011,C1:2006	NB:2013 (nl)

GEOMETRIE

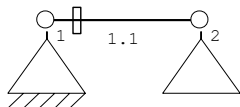

MATERIALEN

Mt	Kwaliteit	E-modulus[N/mm ²]	S.G.	S.G.verhoogd	Pois.	Uitz. coëff
1	C24	11000	3.5	4.2	1.00	5.0000e-06

Bij de bepaling v.h. e.g. van houten staven is de S.G.verhoogd toegepast.

PROFIELEN [mm]

Prof.	Omschrijving	Materiaal	Oppervlak	Traagheid	Vormf.
1	B*H 75*250	1:C24	1.8750e+04	9.7656e+07	0.00

PROFIELEN vervolg [mm]

Prof.	Staaftype	Breedte	Hoogte	e	Type	b1	h1	b2	h2
1	0:Normaal	75	250	125.0	0:RH				

PROFIELVORMEN [mm]

1 B*H 75*250



KNOPEN

Knoop	X	Z
1	0.000	0.000
2	1.200	0.000

Project

5.1.2.e

Projectnummer

210936

Revisie

D



Project.....: 210936

Onderdeel.....: Houten latei

STAVEN

St.	ki	kj	Profiel	Aansl.i	Aansl.j	Lengte	Opm.
1	1	2	1:B*H 75*250	NDM	NDM	1.200	

VASTE STEUNPUNTEN

Nr.	knoop	Kode	XZR 1=vast 0=vrij	Hoek
1	1	110		0.00
2	2	010		0.00

BELASTINGGENERATIE ALGEMEEN.

Betrouwbaarheidsklasse.....:	2	Referentieperiode.....:	50
Gebouwdiepte.....:	0.00	Gebouwhoogte.....:	0.00
Niveau aansl.terrein.....:	0.00	E.g. scheid.w. [kN/m2]:	0.00

STAFTYPEN

Type	staven
1:Vloer.	: 1

LASTVELDEN

Veranderlijke belastingen door personen

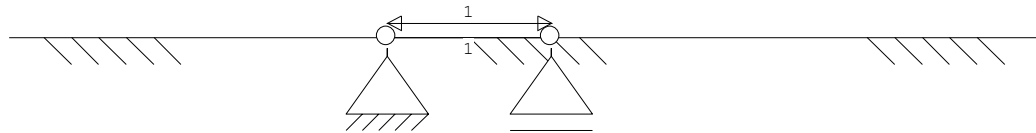

LASTVELDEN

Nr	Staaf	Tabel	Klasse-Gebruiksfunctie	Verd.	q _k	Q _k	F _t /F _{t0}
1	1-1	6.2	A-Vloeren	0	-2.25*	-3.00	1.00

Opmerkingen

[*] Deze belasting is door de gebruiker gewijzigd

BELASTINGGEVALLEN

B.G.	Omschrijving	Type
1	Permanente belasting EGZ=-1.00	1
g	2 Ver. bel. pers. ed. (q _k)	2
g	3 Ver. bel. pers. ed. (Q _k)	3

g = gegeneerd belastinggeval

BELASTINGGEVALLEN vervolg

B.G.	Omschrijving	Belastingduurklasse
1	Permanente belasting	Blijvend
2	Ver. bel. pers. ed. (q _k)	Middellang
3	Ver. bel. pers. ed. (Q _k)	Middellang

Project

5.1, 2, e

Projectnummer

210936

Revisie

D



Project.....: 210936

Onderdeel.....: Houten latei

BELASTINGEN

B.G:1

Permanente belasting

Eigen gewicht van alle staven is meegenomen in berekening. Richting:↓

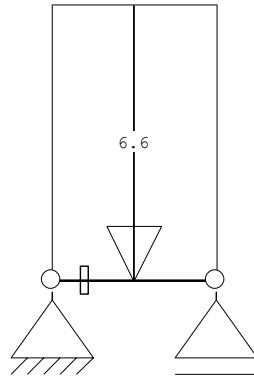

STAAFBELASTINGEN

B.G:1

Permanente belasting

StAAF Type	q1/p/m	q2	A	B	Ψ_0	Ψ_1	Ψ_2
1 5:QZGlobaal	-6.60	-6.60	0.000	0.000			

BELASTINGEN

B.G:2 Ver. bel.

pers. ed. (q_k)

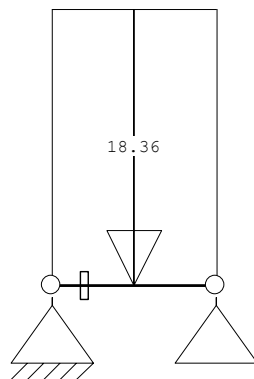

STAAFBELASTINGEN

B.G:2 Ver. bel.

pers. ed. (q_k)

StAAF Type	q1/p/m	q2	A	B	Ψ_0	Ψ_1	Ψ_2
1 3:QZgeProj.	-18.36	-18.36	0.000	0.000	0.40	0.50	0.30

Project

55.1, 2, e

Projectnummer

Revisie

D



Project.....: 210936

Onderdeel.....: Houten latei

SITUATIES BELAST/ONBELAST

B.G:2 Ver. bel. pers.

ed. (q_k)

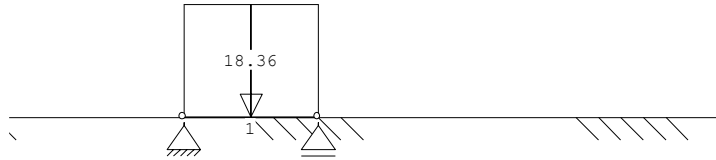

SITUATIES BELAST/ONBELAST

Belastingtype: q_k

Nr Lastvelden belast	Lastvelden onbelast
1	1

BELASTINGEN

B.G:3 Ver. bel.

pers. ed. (Q_k)

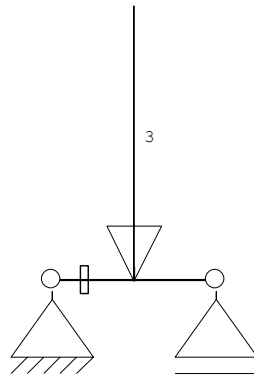

STAAFBELASTINGEN

B.G:3 Ver. bel.

pers. ed. (Q_k)

StAAF Type	q1/p/m	q2	A	B	ψ ₀	ψ ₁	ψ ₂
1 10:PZGeproj.	-3.00		0.600		0.40	0.50	0.30

SITUATIES BELAST/ONBELAST

B.G:3 Ver. bel. pers.

ed. (Q_k)

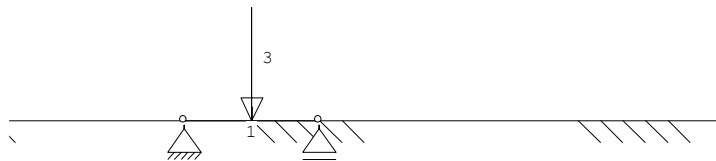

SITUATIES BELAST/ONBELAST

Belastingtype: Q_k

Nr Lastvelden belast	Lastvelden onbelast
1	1

BEREKENINGSTATUS

B.C.	Iteratie	Status
1	3	Nauwkeurigheid bereikt
2	3	Nauwkeurigheid bereikt
3	3	Nauwkeurigheid bereikt
4	3	Nauwkeurigheid bereikt
5	3	Nauwkeurigheid bereikt

Project

5.1, 2, e

Projectnummer

210936

Revisie

D

IRg

Project.....: 210936

Onderdeel.....: Houten latei

BEREKENINGSTATUS

B.C. Iteratie Status

6	3	Nauwkeurigheid bereikt
7	3	Nauwkeurigheid bereikt
8	3	Nauwkeurigheid bereikt
9	3	Nauwkeurigheid bereikt
10	3	Nauwkeurigheid bereikt
11	3	Nauwkeurigheid bereikt
12	3	Nauwkeurigheid bereikt
13	3	Nauwkeurigheid bereikt
14	3	Nauwkeurigheid bereikt
15	1	Lineaire berekening
16	1	Lineaire berekening
17	1	Lineaire berekening
18	1	Lineaire berekening
19	1	Lineaire berekening
20	1	Lineaire berekening
21	1	Lineaire berekening
22	1	Lineaire berekening
23	1	Lineaire berekening

BELASTINGCOMBINATIES

BC Type

1	Fund.	1.30	$G_{k,1}$		
2	Fund.	0.90	$G_{k,1}$		
3	Fund.	1.30	$G_{k,1}$	+	1.30 $\Psi_0 Q_{k,2}$
4	Fund.	1.30	$G_{k,1}$	+	1.30 $\Psi_0 Q_{k,3}$
5	Fund.	1.15	$G_{k,1}$	+	1.30 $Q_{k,2}$
6	Fund.	1.15	$G_{k,1}$	+	1.30 $Q_{k,3}$
7	Fund.	1.10	$G_{k,1}$	+	1.50 $Q_{k,2}$
8	Fund.	1.10	$G_{k,1}$	+	1.50 $Q_{k,3}$
9	Fund.	0.90	$G_{k,1}$	+	1.50 $Q_{k,2}$
10	Fund.	0.90	$G_{k,1}$	+	1.30 $\Psi_0 Q_{k,2}$
11	Fund.	0.90	$G_{k,1}$	+	1.30 $Q_{k,2}$
12	Fund.	0.90	$G_{k,1}$	+	1.50 $Q_{k,3}$
13	Fund.	0.90	$G_{k,1}$	+	1.30 $\Psi_0 Q_{k,3}$
14	Fund.	0.90	$G_{k,1}$	+	1.30 $Q_{k,3}$
15	Kar.	1.00	$G_{k,1}$	+	1.00 $Q_{k,2}$
16	Kar.	1.00	$G_{k,1}$	+	1.00 $Q_{k,3}$
17	Quas.	1.00	$G_{k,1}$		
18	Quas.	1.00	$G_{k,1}$	+	1.00 $\Psi_2 Q_{k,2}$
19	Quas.	1.00	$G_{k,1}$	+	1.00 $\Psi_2 Q_{k,3}$
20	Freq.	1.00	$G_{k,1}$		
21	Freq.	1.00	$G_{k,1}$	+	1.00 $\Psi_1 Q_{k,2}$
22	Freq.	1.00	$G_{k,1}$	+	1.00 $\Psi_1 Q_{k,3}$
23	Blij.	1.00	$G_{k,1}$		

GUNSTIGE WERKING PERMANENTE BELASTINGEN

BC Staven met gunstige werking

1	Geen
2	Alle staven de factor:0.90
3	Geen
4	Geen
5	Geen
6	Geen
7	Geen
8	Geen
9	Alle staven de factor:0.90
10	Alle staven de factor:0.90
11	Alle staven de factor:0.90
12	Alle staven de factor:0.90
13	Alle staven de factor:0.90
14	Alle staven de factor:0.90

Project

5.5.1, 2, e

Projectnummer

210936

Revisie

D

IRg

Project.....: 210936

Onderdeel.....: Houten latei

OMHULLENDE VAN DE FUNDAMENTELE COMBINATIES

MOMENTEN 2e orde
Fundamentele combinatie

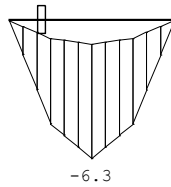

DWARSKRACHTEN 2e orde
Fundamentele combinatie

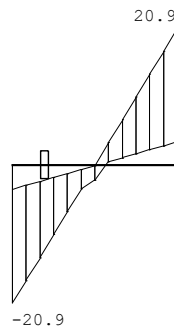

NORMAALKRACHTEN 2e orde
Fundamentele combinatie

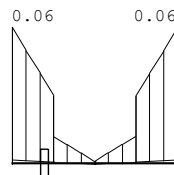

REACTIES 2e orde
Fundamentele combinatie

Kn.	X-min	X-max	Z-min	Z-max	M-min	M-max
1	0.00	0.00	3.61	20.93		
2			3.61	20.93		

Project

5.5.1, 2, e

Projectnummer

Revisie

D

IRg

Project.....: 210936

Onderdeel.....: Houten latei

OMHULLENDE VAN DE KARAKTERISTIEKE COMBINATIES**VERPLAATSINGEN** 1e orde [mm]

Karakteristieke combinatie

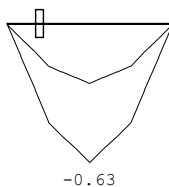
**REACTIES** 1e orde

Karakteristieke combinatie

Kn.	X-min	X-max	Z-min	Z-max	M-min	M-max
1	0.00	0.00	5.51	15.02		
2			5.51	15.02		

MATERIAALGEGEVENS

Mt	Kwaliteit	$f_{m,y,k}$ [N/mm ²]	ρ_k [kg/m ³]	ρ_{mean} [kg/m ³]	$f_{t,0,k}$ [N/mm ²]	$f_{t,90,k}$ [N/mm ²]	$f_{c,0,k}$ [N/mm ²]	$f_{c,90,k}$ [N/mm ²]	$f_{v,k}$ [N/mm ²]
1	C24	24	350	420	14.5	0.4	21.0	2.5	4.0

MATERIAALGEGEVENS (vervolg)

Mt	Kwaliteit	G_{mean} [N/mm ²]	$E_{0,05}$ [N/mm ²]	E_{90mean} [N/mm ²]	$E_{0,mean}$ [N/mm ²]	Klimaatklasse	k_{def}	$E_{0mean,fin}$ [N/mm ²]
1	C24	690	7400	370	11000	I	0.60	6875

KIPSTABILITEIT

Staf	Plts. aanr.	1 sys.	Kipsteunafstanden [m] [m]
1	1.0*h	boven: onder:	1.20 0;1.200 1.20 0;1.200

STABILITEIT

Stf	b_{gem} [mm]	h_{gem} [mm]	l_{sys} [mm]	$l_{buc,y/z}$ [mm]	λ_y	λ_z	$\lambda_{rel,y/z}$	β_c	k_y	k_z	$k_{c,y}$	$k_{c,z}$
1	75	250	1200	nvt 1200	16.6	55.4	0.282 0.940	0.2	0.538	1.006	1.004	0.733

STABILITEIT (vervolg)

Staf	positie [mm]	$l_{ef,y}$ [mm]	$\sigma_{my,crit}$ [N/mm ²]	$\lambda_{rel,my}$	$k_{crit,y}$
1	0	1580	82.20	0.54	1.00

TOETSING SPANNINGEN

Staf	1	BC / Sit.	7 / 1	UC frm(6.13)	0.68
------	---	-----------	-------	--------------	------

TOETSING DOORBUIGING

Stf	Soort	l_{sys} [mm]	Overstek i j	BC Sit	u_{bij} [mm]	Toelaatbaar *1	$u_{fin,net}$ [mm]	Toelaatbaar *1		
1	Vloer	1200	Nee Nee	18 1	-0.6	-3.6	0.003	-0.8	-4.8	0.004

TOETSING DOORBUIGING (vervolg)

Stf	Soort	l_{sys} [mm]	Overstek i j	Zeeg [mm]	BC Sit	u_{inst} [mm]	Toelaatbaar [mm]	*1
1	Vloer	1200	Nee Nee	0.0 15	1	-0.6	-4.8	0.004

Project

55.1, 2, e

Projectnummer

Revisie

D

IRg

Project.....: 210936

Onderdeel.....: Houten latei

VERVORMINGEN W_{max}

Karakteristieke combinatie

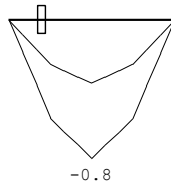

DOORBUIGINGEN

Karakteristieke combinatie

Nr.	staven	Zijde	positie	l_{rep}	w_1	w_2	w_{bij}	w_{tot}	w_c	w_{max}
			[m]	[mm]	[mm]	[mm]	[mm]	[mm]	[mm]	[mm]
1	1	Neg.	0.600	1200	-0.2	-0.2	-0.6	1860	-0.8	-0.8